



Università degli Studi di Milano-Bicocca  
Dipartimento di Matematica e Applicazioni

Joint PhD Program in Mathematics Milano-Bicocca - Pavia - INDAM  
Cycle XXXVI  
Curriculum in Analysis

Qualitative properties of elliptic operators  
on Riemannian manifolds

**Candidate:** Andrea Bisterzo  
**ID number:** 876819

**Supervisor:** Prof. Stefano Pigola  
**Coordinator:** Prof. Pierluigi Colli

Academic Year 2022/2023

*A Giulia, Bruno e Luisa.*

---

# Contents

---

<b>I</b>	<b>Maximum Principles and symmetry results</b>	<b>1</b>
	<b>Introduction to Part I</b>	<b>3</b>
<b>1</b>	<b>Maximum Principles in unbounded Riemannian domains</b>	<b>9</b>
1.1	Maximum Principle in warped product manifolds . . . . .	9
1.1.1	$\mathcal{D}$ -parabolic manifolds . . . . .	12
1.1.2	$\mathcal{D}$ -parabolicity and Maximum Principle in warped products . . . . .	13
1.1.2.1	$\mathcal{D}$ -parabolicity . . . . .	13
1.1.2.2	Maximum Principle . . . . .	18
1.2	Maximum Principle via an Alexandroff-Bakelman-Pucci estimate . . . . .	19
1.2.1	ABP inequality . . . . .	19
1.2.2	Generalized principal eigenfunction in general bounded domains . . . . .	28
1.2.3	Generalized principal eigenfunction in smooth unbounded domains . . . . .	36
1.2.4	Maximum principle in smooth unbounded domains . . . . .	37
<b>2</b>	<b>Symmetry under stability</b>	<b>45</b>
2.1	Basic notation . . . . .	45
2.1.1	Symmetry under stability . . . . .	47
2.2	Symmetric domains . . . . .	48
2.2.1	Isoparametric domains and tubes . . . . .	49
2.2.2	Homogeneous domains . . . . .	49
2.2.3	Examples . . . . .	51
2.2.4	Weighted symmetric domains . . . . .	54
2.3	Symmetric functions . . . . .	57
2.3.1	Local vs global symmetry . . . . .	58
2.4	Maximum principles, uniqueness and symmetry . . . . .	59
2.4.1	Compact maximum principle . . . . .	59
2.4.2	Non-compact maximum principle: parabolicity . . . . .	62
2.4.3	Uniqueness . . . . .	63
2.4.4	Symmetry via average . . . . .	66
2.5	Symmetry of solutions on $\Psi$ -homogeneous domains . . . . .	67

2.5.1	The noncompact case . . . . .	70
2.6	Symmetry of solutions in a non-homogeneous case . . . . .	71
2.6.1	A non-compact symmetry result: statement and comments . . . . .	73
2.6.2	Some preliminary lemmas . . . . .	76
2.6.3	Proof of Theorem 2.6.5 . . . . .	79
2.6.4	Infinite annuli . . . . .	80
2.6.5	Generalization under the assumption of strong stability . . . . .	81
 <b>II Positivity preservation</b>		<b>83</b>
 <b>Introduction to Part II</b>		<b>85</b>
<b>3</b>	<b><math>L^p</math> Positivity preservation: <math>p = 1</math> and <math>p = +\infty</math></b>	<b>91</b>
3.1	$L^\infty$ positivity preserving property and stochastic completeness . . . . .	91
3.1.1	From stochastic completeness to the $L^\infty$ positivity preserving property	94
3.2	Monotone approximation results . . . . .	96
3.2.1	Representation formula for $\alpha$ -harmonic functions . . . . .	97
3.2.2	Distributional vs. potential $\alpha$ -subharmonic solutions . . . . .	99
3.2.3	Proof of Theorem 3.2.2 . . . . .	100
3.2.4	Proof of Theorem 3.1.7 . . . . .	103
3.2.5	Remarks on the global case . . . . .	104
3.3	A counterexample for $p = 1$ . . . . .	105
<b>4</b>	<b><math>L^p_{loc}</math> positivity preservation and Liouville-type theorems</b>	<b>109</b>
4.1	Some preliminary results . . . . .	109
4.2	$L^p_{loc}$ positivity preserving property . . . . .	111
4.3	$L^1_{loc}$ positivity preserving property . . . . .	117
4.3.1	Cut-off functions with decaying laplacians . . . . .	117
4.3.2	Cut-off functions with equibounded laplacians . . . . .	120
4.4	An application to minimal submanifolds . . . . .	122
<b>5</b>	<b><math>L^p</math> positivity preservation and self-adjointness</b>	<b>125</b>
5.1	$L^p$ positivity preservation . . . . .	125
5.1.1	Preliminary results . . . . .	126
5.1.2	Positivity preserving . . . . .	127
5.2	Essential self-adjointness . . . . .	131
5.2.1	Standard notions and results about self-adjointness . . . . .	131
5.2.2	Essential self-adjointness of $-\Delta + V$ . . . . .	132
5.3	Operator core . . . . .	133
5.3.1	Standard notions and results about accretive operators . . . . .	134
5.3.2	Main result . . . . .	135
5.3.2.1	$\overline{(-\Delta + V)_{p,min}}$ is m-accretive . . . . .	136
5.3.2.2	$(-\Delta + V)_{p,max}$ is m-accretive . . . . .	138
5.3.2.3	$C_c^\infty$ is an operator core for $(-\Delta + V)_{p,max}$ . . . . .	139

5.3.3	Consequence of the above construction . . . . .	141
-------	---	-----



---

# Ringraziamenti

---

Non possono che iniziare ringraziando Giulia. Sia perché mi ha spronato ad iniziare il dottorato, sia (cosa più importante) perché mi ha aiutato a fronteggiare i momenti più difficili e sconfortanti di questo percorso, rendendo leggeri e sereni anche i giorni più pesanti. È stata lei a farmi credere in me stesso e in quello che stavo facendo. Per il suo supporto indispensabile e per molto altro, la ringrazio.

Un'altra persona che sento di dover ringraziare in special modo è Stefano. A lui va il merito di avermi fatto crescere sia da un punto di vista accademico che personale. La sua gentilezza e la sua umanità mi hanno fatto sentire a mio agio in ogni discussione che abbiamo avuto, non facendomi mai pesare il divario matematico che c'è tra noi. La sua conoscenza e la passione che ha per l'Analisi Geometrica mi hanno dato modo di imparare molto e rimanerne affascinato. È stato la guida che ogni dottorando dovrebbe avere.

Allo stesso modo ringrazio Giona, Alberto e Ludovico per avermi dato l'opportunità di collaborare e di imparare molto da loro, intavolando spesso discussioni stimolanti e formative.

Ringrazio poi Alessandro e Luigi per l'ospitalità che mi hanno riservato durante il mio periodo a Roma. Mi hanno accolto nel migliore dei modi, rendendo la permanenza piacevole sia umanamente che professionalmente.

Una parentesi a parte è per i dottorandi del 36° ciclo, con i quali ho condiviso interamente questo percorso, e per tutti gli U5 goers che, più o meno intensamente, hanno riempito questi tre anni. Li ringrazio soprattutto per le avventure e per i bei momenti trascorsi insieme: l'Isola d'Elba, le gite, le partite a pallavolo, le pause, le serate in compagnia. Ma anche le missioni, rese più piacevoli dalla loro compagnia, ed i progetti portati avanti. Tra i molti goers, una menzione speciale è per coloro con i quali si è creato un legame di amicizia coltivato anche fuori dal dipartimento.

Dedico poi uno spazio tutto loro a Fede, Elena, Giovanni e Ninni, che sono riusciti a farsi volere bene. Il solo avervi conosciuti vale le difficoltà affrontate in questi tre anni.

Un grazie va, anche questa volta, agli amici di sempre: Marco, Raffaele, Fausto, Iulian e Matteo. Le serate trascorse insieme (online o di persona) sono state occasioni preziose di svago e spensieratezza che hanno contribuito a rendere più piacevole questo percorso.

Infine, ci tengo a ringraziare il Dipartimento di Matematica di Milano-Bicocca e i coordinatori del dottorato congiunto Milano-Pavia-INdAM. Li ringrazio non solo per avermi dato l'opportunità di intraprendere questo percorso, ma anche per aver sostenuto i progetti e le richieste che noi dottorandi abbiamo portato avanti durante questi anni.





---

# Introduction

---

The present thesis aims to expose the topics explored and the results obtained during my PhD program. The structure of the thesis is divided, in a natural fashion, in two parts. This division is due to both the diversity of the topics discussed and the difference of the approaches adopted. The common thread connecting these two parts is something that has been woven into my studies from the very beginning and has persisted throughout all the three years of my doctoral program: the investigation of the qualitative properties of differential operators defined over Riemannian manifolds.

By qualitative properties we mean all those properties that cannot be numerically quantified. Among the plenty of results falling within the quantitative realm, I have focused my studies on those about

- structural properties of solutions to differential equations (such as the maximum principles or the symmetry, stability and uniqueness properties) or of domains where these equations are defined (like the rigidity results);
- spectral properties of the differential operators (for instance, the selfadjointness and the preservation of positivity).

## Plan of the work

Part I of this thesis is devoted to the maximum principles for second order, elliptic, differential operators and to their application into the study of the relationship that exists between symmetry and stability of solutions to semilinear Dirichlet problems.

In Chapter 1 we address the problem of finding a maximum principle in unbounded Riemannian domains. We have achieved two major results, each obtained under different assumptions and with distinct techniques. The first one is a maximum principle for domains of warped product manifolds contained in the complement of a strip, which generalizes a classical Euclidean result for domains contained in the complement of a cone. The second result is about the validity of a maximum principle on general unbounded domains under the hypothesis that the first (generalized) eigenvalue of the operator is positive. For this theorem it has been essential the achievement of an Alexandroff-Bakelmann-Pucci estimate on Riemannian manifolds.

To follow, in Chapter 2 we present some symmetry results for stable solutions to Dirichlet problems defined over specific symmetric domains. These results are obtained

using different versions of the maximum principle, including those proved in the first chapter. In particular, we present two theorems treating respectively the cases of a plenty and of a lack of enough isometries acting on the domain we are considering.

In Part II our goal is to investigate a particular differential property of Schrödinger operators defined over Riemannian manifolds: the  $L^p$ -preservation of positivity. This property has been widely studied in the recent years and it is tied hand in glove to the essential selfadjointness of such operators. It is worth noting that the preservation of positivity for the operator  $-\Delta + 1$  acting on  $L^p$  functions,  $p \in (1, +\infty)$ , is implied by the geodesic completeness of the manifold.

In Chapter 3 we show that the validity of the positivity preserving property for the operator  $-\Delta + 1$  acting on  $L^\infty$  functions is, in fact, equivalent to the stochastic completeness of the manifold at hand. We get this result by employing a monotone approximation through smooth (bounded) subsolutions. In conclusion, we provide a counterexample showing that in case  $p = 1$  geodesic completeness and preservation of positivity are generally unrelated.

Chapter 4 deals with more general Schrödinger operators, having a positive and locally bounded potential, defined over a complete Riemannian manifold. Thanks to some iterative lemmas, we managed to prove the positivity preserving property over the class of  $L^p_{loc}$  functions whose  $L^p$  norm over geodesic balls grows at a certain rate. This growth depends both on the value of  $p \in [1, +\infty)$  and on the decay rate of the potential at infinity.

Finally, in Chapter 5 we settle our study in incomplete Riemannian manifolds obtained by cutting off a compact subset  $K$  from a complete manifold. By assuming a Minkowski condition on the size of the compact set, we obtain the  $L^p$  positivity preserving property for Schrödinger operators whose potential diverges to  $+\infty$  nearby  $K$ . Using this result, we also prove that the family of compactly supported smooth functions is a core for such operators, thereby showing that they are essentially selfadjoint in the case  $p = 2$ .

## Basic notation

Unless otherwise explicitly stated, the following notation will be used throughout all the chapters of this thesis. For some standard references see [80, 31, 53].

**Riemannian manifolds.** With  $(M, g)$ , we denote a Riemannian manifold of dimension  $\dim(M) = n$ , i.e., a connected differentiable manifold  $M$  (with or without boundary) of dimension  $n$  equipped with a Riemannian metric  $g$ . The symbol  $d^M(\cdot, \cdot) : M \times M \rightarrow \mathbb{R}_{\geq 0}$  denotes the intrinsic distance induced by  $g$  on  $M$  and  $B^M_R(p)$  the open geodesic ball of radius  $R$  centred at  $p \in M$

$$B^M_R(p) := \{x \in M : d^M(x, p) < R\}.$$

Furthermore, recall that a Riemannian manifold is said to be *complete* if the metric space  $(M, d)$  is complete. In the case where the manifold has empty boundary, the completeness of the space  $(M, d)$  is equivalent to the *geodesic completeness* of the Riemannian manifold

$(M, g)$ , which means that every geodesic  $\gamma : (a, b) \rightarrow M$  can be extended to a geodesic defined for all times  $t \in \mathbb{R}$ .

If  $\Omega \subseteq M$  is a domain, that is, an open and connected subset, we denote its diameter by

$$\text{diam}(\Omega) := \sup_{(x,y) \in \Omega \times \Omega} d^M(x, y).$$

The symbol  $\Omega \Subset M$  means that  $\Omega$  has compact closure in  $M$ .

Let  $x \in M$ . The *exponential map* at  $x$  is defined as the map  $\exp_x : T_x M \rightarrow M$  which associates each  $v \in T_x M$  to the geodesic starting at  $x$  with initial velocity  $v$ . The *injectivity radius at  $x$*  is given by the following quantity

$$\text{inj}_{(M,g)}(x) := \sup\{\epsilon > 0 : \exp_x : B_\epsilon(0) \subseteq T_x M \rightarrow M \text{ is a diffeomorphism onto its image}\}.$$

We denote the *injectivity radius of  $M$*  as

$$\text{inj}_{(M,g)} := \inf_{x \in M} \text{inj}_{(M,g)}(x).$$

**Intrinsic curvatures.** If  $\mathfrak{X}(M)$  is the space of smooth vector fields on  $M$ , let  $\nabla^M : TM \times \mathfrak{X}(M) \rightarrow \mathfrak{X}(M)$  be the *Levi-Civita connection* associated with the metric  $g$  and  $\Gamma_{ij}^k$  its *Christoffel symbols*. We denote by  $R^M$  the *Riemann curvature tensor* of type  $(4,0)$

$$R^M(X, Y, Z, W) := g\left(\nabla_Y^M \nabla_X^M Z - \nabla_X^M \nabla_Y^M Z + \nabla_{[X,Y]}^M Z, W\right).$$

Contracting the Riemann tensor with respect to the second and fourth entries, we obtain the *Ricci curvature tensor*

$$\text{Ric}^M(X, Y) := \sum_i R^M(X, E_i, Y, E_i)$$

where  $\{E_i\}_i$  is a local orthonormal frame.

Given any  $x \in M$  and any pair of linearly independent vectors  $v, w \in T_x M$ , recall that the *sectional curvature* associated with the plane spanned by  $v$  and  $w$  is defined as

$$\text{Sect}^M(v \wedge w) := \frac{R^M(V, W, V, W)}{g(V, V)g(W, W) - g(V, W)^2}$$

where  $V$  and  $W$  are vector fields on  $M$  extending  $v$  and  $w$ , respectively. Note that this definition does not depend on the vectors  $v$  and  $w$  (nor on their extensions  $V$  and  $W$ ) but solely on the plane  $\text{Span}_{\mathbb{R}}\{v, w\}$ . In the particular case where the manifold  $M$  has dimension two, the sectional curvature is also called the *Gaussian curvature*.

**Extrinsic curvatures** Let  $\Sigma \subset M$  be a Riemannian submanifold of dimension  $\dim(\Sigma) = k < n$ . We recall that the *vectorial second fundamental form* associated with  $\Sigma \hookrightarrow M$  and evaluated at  $x \in \Sigma$  is defined as follows:

$$\begin{aligned} \vec{\Pi}^\Sigma(x) : T_x \Sigma \times T_x \Sigma &\rightarrow T_x \Sigma \\ (u, v) &\mapsto \left(-\nabla_U^M V(x)\right)^\perp \end{aligned}$$

where  $U$  and  $V$  are (local) vector fields on  $M$  so that  $U|_\Sigma$  and  $V|_\Sigma$  are tangent to  $\Sigma$  and extending  $u$  and  $v$  respectively, and  $X^\perp$  represents the (pointwise) projection of the vector field  $X$  onto the normal bundle  $N\Sigma \hookrightarrow TM$ . The *mean curvature vector* at  $x$  of the submanifold  $\Sigma$  is defined as

$$\vec{H}^\Sigma(x) := \frac{1}{k} \text{trace}(\vec{\Pi}^\Sigma) = \frac{1}{k} \sum_i \vec{\Pi}^\Sigma(E_i, E_i)$$

where  $\{E_i\}_i$  is a local orthonormal frame of  $\Sigma$  around  $x$ . In case  $\Sigma$  is an hypersurface of  $M$ , the normal bundle to  $\Sigma$  is a rank one vector bundle and locally can be spanned by a unit normal field  $\vec{\nu}$ . It follows that  $\vec{H}^\Sigma // \vec{\nu}$  and so, locally,

$$\vec{H}^\Sigma(x) = H^\Sigma(x) \vec{\nu}(x)$$

where  $H^\Sigma(x)$  denotes the (*scalar*) *mean curvature* at  $x$ . This formula exists globally when the hypersurfaces is 2-sided.

**Differential operators.** Let  $X$  be a vector field on  $M$  and  $\{E_i\}_i$  a (local) orthonormal frame. We recall that the *divergence* of the vector field  $X$  is locally defined as follows:

$$\text{div}^M(X) := \sum_i g(\nabla_{E_i}^M X, E_i).$$

If  $u \in C^\infty(M)$ , we denote with  $\nabla^M u$  the *gradient* of  $u$ , which is the vector field such that

$$du[X] = g(\nabla^M u, X) \quad \forall X \in \mathfrak{X}(M),$$

where  $d$  denotes the exterior derivative on  $M$ . The *Hessian* of  $u$  is defined as the symmetric  $(2,0)$ -tensor field that acts as

$$\begin{aligned} \text{Hess}(u)(X, Y) &:= Y(X(u)) - du[\nabla_Y^M X] \\ &= g(X, \nabla_Y^M \nabla^M u), \end{aligned}$$

where  $X$  and  $Y$  are vector fields on  $M$ . Tracing the Hessian of  $u$ , we obtain the *Laplacian* of  $u$  (also known as the *Laplace-Beltrami operator* of  $u$ )

$$\Delta^M u := \text{trace Hess}(u) = \text{div}^M(\nabla^M u).$$

**Lebesgue and Sobolev spaces.** Let  $dv$  be the Riemannian measure associated with the Riemannian manifold  $(M, g)$ . We indicate the *Lebesgue space* of index  $p \in [1, +\infty]$  with respect to the measure induced by the volume form  $dv$  as  $L^p(M) := L^p(M, dv)$ . For  $k \in \mathbb{N}$ , the *Sobolev space* of indices  $k$  and  $p \in [1, +\infty]$  is denoted as  $W^{k,p}(M) := W^{k,p}(M, dv)$ .

As is well known, [53], these spaces are Banach spaces (and Hilbert spaces in the case  $p = 2$ ) when respectively equipped with the norms

$$\|u\|_{L^p} := \int_M |u|^p dv$$

and

$$\|u\|_{W^{k,p}} := \sum_{i=0}^k \|\nabla^i u\|_{L^p}.$$

The local Lebesgue and Sobolev spaces are denoted as  $L_{loc}^p$  and  $W_{loc}^{k,p}$ , for  $p \in [1, +\infty]$  and  $k \in \mathbb{N}$ . Finally, if  $\Omega \subset M$  we indicate

$$W_0^{k,p} := \overline{C_c^\infty(\Omega)}^{\|\cdot\|_{W^{k,p}}}.$$

In the following, we will omit the superscripts (e.g., for denoting the connection or the curvatures) whenever there is no danger of confusion.



## Part I

# Maximum Principles and symmetry results





---

# Introduction to Part I

---

Part I of this thesis deals with maximum principles and symmetry properties for solutions to semilinear partial differential equations of the form

$$\mathcal{L}u = f(u) \quad \text{in } \Omega,$$

where

$$\mathcal{L}u = \operatorname{div}(A(x) \cdot \nabla u(x)) + g(B(x), \nabla u(x)) + c(x)u(x),$$

$f$  is a smooth function and  $\Omega \subseteq (M, g)$  is a Riemannian domain. More in detail, Chapter 1 is devoted to the study of the validity of a Maximum Principle in unbounded domains, while Chapter 2 deals with the investigation of the link between stability and symmetry of solutions in particular (symmetric) domains.

**Chapter 1** In the first chapter we address the validity of the maximum principle for bounded solutions to the problem

$$\begin{cases} \Delta u - cu \geq 0 & \text{in } \Omega \\ u \leq 0 & \text{on } \partial\Omega \end{cases}$$

where  $\Omega$  is an unbounded domain inside the Riemannian manifold  $(M, g)$ . We shall present two kind of results where the common root is the assumption that  $\Omega$  is “small” from the viewpoint of the operator. The first result requires that the underlying manifold has a special structure (warped product cylinder) and the smallness of the domain is encoded in its (Dirichlet) parabolicity. The second result has a more abstract flavour as it holds in any Riemannian manifold provided that the domain is small in a spectral sense.

In the Euclidean setting a classical result for unbounded domains contained in the complement of a solid cone  $\Omega \subseteq \mathbb{R}^n \setminus \mathcal{C}$  states that, fixed  $0 \leq c \in C^0(\Omega)$ , every solution to

$$\begin{cases} \Delta u - c u \geq 0 & \text{in } \Omega \\ u \leq 0 & \text{on } \partial\Omega \\ \sup_{\Omega} u < +\infty \end{cases}$$

is nonnegative in the whole domain  $\Omega$  (for a reference see [10]).

The proof is essentially based on the fact that the Euclidean space is a model manifold, that is, the manifold obtained by quotienting the warped product  $([0, +\infty) \times \mathbb{S}^{n-1}, dr \otimes$

$dr + r^2 g^{\mathbb{S}^{n-1}}$ ) with respect to the relation that identifies  $\{0\} \times \mathbb{S}^{n-1}$  with the point  $o$ , called *pole*, and then extending smoothly the metric in  $o$ .

Influenced by the model structure of  $\mathbb{R}^n$ , in Section 1.1.2 we obtain a transposition of the previous theorem to warped product manifolds satisfying certain (radial) curvature conditions and replacing the notion of *cone* with the notion of *strip*. The assumptions on the geometry of  $M$  and on  $\Omega$  are needed to construct a suitable barrier function, crucial for the validity of the result. We stress that the main theorem of Section 1.1.2 is first stated in the context of (Dirichlet-)parabolic manifolds and then reinterpreted in the language of maximum principles, obtaining the following

**Theorem I.A** (Unbounded maximum principle). *Let  $M = \mathbb{R}_{\geq 0} \times_{\sigma} N$  be a warped product manifold of dimension  $\dim(M) \geq 2$ , where  $\sigma : \mathbb{R}_{> 0} \rightarrow \mathbb{R}_{> 0}$  is a smooth function and  $N$  a closed manifold. Consider  $\Omega \subset M$  an unbounded domain whose closure is contained in the strip  $[0, +\infty) \times \Lambda$ , where  $\Lambda \subset N$  is a non-empty, smooth and connected open subset of  $N$  such that  $\bar{\Lambda} \neq N$ . Moreover, suppose the validity of either one of the following conditions*

1.  $\text{Ric}_{rr} \leq 0$  eventually and  $\lim_{r \rightarrow \infty} \sigma(r) = c \in [0, +\infty)$ ;
2.  $\text{Ric}_{rr} \geq 0$  eventually and  $\lim_{r \rightarrow \infty} \sigma(r) = c \in (0, +\infty)$ ;
3.  $\sigma \in O(r^{\beta})$  for  $0 < \beta < \frac{1}{2}$  as  $r \rightarrow \infty$  and  $\frac{\sigma'}{\sigma} \in L^{\infty}(+\infty)$ .

If  $u \in C^0(\bar{\Omega}) \cap W_{loc}^{1,2}(\Omega)$  is a bounded above distributional solution to the problem

$$\begin{cases} \Delta u - c u \geq 0 & \text{in } \Omega \\ u \leq 0 & \text{on } \partial\Omega, \end{cases}$$

where  $0 \leq c \in C^0(\Omega)$ , then  $u \leq 0$  in  $\Omega$ .

On the other hand, if we want to recover a maximum principle without requiring any assumption on the structure of the manifold (and of the domain), then we have to consider some additional hypotheses on the differential operator and on its spectrum. These kinds of assumptions are natural if one compares with the compact case. Indeed, if  $\Omega \subseteq (M, g)$  is a bounded Riemannian domain and  $\mathcal{L}$  is a linear, second order, elliptic operator with (sufficiently) regular coefficients, then the Maximum Principle holds for  $\mathcal{L}$  in  $\Omega$  with Dirichlet boundary conditions if and only if the first Dirichlet eigenvalue of  $\mathcal{L}$  on  $\Omega$  is positive.

Inspired by this fact, one might wonder if this property can be generalized to unbounded domains. This is true in the Euclidean space according to the very interesting work [77] by Samuel Nordmann. In Section 1.2 we shall extend Nordmann result to Riemannian domains.

The first step consists in proving the following Alexandroff-Bakelman-Pucci-like inequality (ABP) for the differential operator  $\mathcal{M}$ , which is obtained from  $\mathcal{L}$  by removing its zeroth-order term (if any).

**Theorem I.B.** *Let  $(M, g)$  be a complete Riemannian manifold of dimension  $\dim(M) = n$  and  $\Omega \Subset M$  a bounded smooth domain.*

Then, there exists a positive constant  $C$  (depending on  $\mathcal{M}$  and on the geometry of  $\Omega$ ) such that for every  $u \in C^2(\Omega)$  satisfying

$$\begin{cases} \mathcal{M}u \geq f & \text{in } \Omega \\ \limsup_{x \rightarrow \partial\Omega} u(x) \leq 0, \end{cases}$$

it holds

$$\sup_{\Omega} u \leq C \operatorname{diam}(\Omega) \|f\|_{L^n(\Omega)}.$$

In particular

$$\sup_{\Omega} u \leq C \operatorname{diam}(\Omega) |\Omega|^{1/n} \|f\|_{L^\infty(\Omega)}.$$

The technique used for the proof of this result is inspired by the one adopted by X. Cabré in [25], where the author proved an ABP inequality on Riemannian manifolds with nonnegative sectional curvature. The proof of [25, Theorem 2.3] is very technical and relies on a dyadic decomposition of the domain and on a global doubling property of the Riemannian measure. Thanks to these two fundamental tools, Cabré obtained an Alexandroff-Bakelmann-Pucci inequality whose constant  $C_\theta$  does not depend on the domain considered.

In Sections 1.2.2 and 1.2.3 we use Theorem I.B to construct a couple of generalized eigenvalues  $(\lambda_1, \varphi)$  for  $\mathcal{L}$  on possibly nonsmooth bounded domains and, using an exhaustion argument, on unbounded smooth domains. As we shall see,  $\lambda_1$  and  $\varphi$  coincide with the classical first eigenvalue and first eigenfunction in the case  $\Omega$  is a compact smooth domain.

We conclude Section 1.2 with next maximum principle valid in unbounded smooth domains of a general Riemannian manifold under the assumption that  $\lambda_1 > 0$ , recovering a link between the validity of the maximum principle and the positivity of the (generalized) principal eigenvalue also in noncompact Riemannian domains.

**Theorem I.C.** *Let  $(M, g)$  be a Riemannian manifold and  $\Omega \subset M$  a (possibly unbounded) smooth domain. If  $\lambda_1^{-\mathcal{L}}(\Omega) > 0$ , then every function  $u \in C^2(\overline{\Omega})$  that satisfies*

$$\begin{cases} \mathcal{L}u \geq 0 & \text{in } \Omega \\ u \leq 0 & \text{on } \partial\Omega \\ \sup_{\Omega} u < +\infty \end{cases}$$

is nonpositive.

**Chapter 2** The second chapter of Part I deals with symmetry phenomena for stable solutions to semilinear PDEs. Inspired by the classical result by Gidas, Ni and Nirenberg [40], we try to face the following problem

**Problem I.D.** Let  $\Omega \subseteq (M, g)$  be a smooth Riemannian domain and  $u$  a regular solution to

$$\begin{cases} \Delta u = f(u) & \text{in } \Omega \\ u \text{ loc. const.} & \text{on } \partial\Omega. \end{cases}$$

If the domain displays a certain symmetry, what kind of assumptions we have to consider on  $u$  to ensure that the symmetry of the domain propagates to the function too?

In particular, in Chapter 2 we settle the study of this problem in the general framework of weighted Riemannian manifolds  $(M, g, e^{-\Psi} \text{d}v)$ , where  $\Psi : M \rightarrow \mathbb{R}$  is a smooth function. In this setting it is natural to replace the standard Laplace-Beltrami operator with its weighted version

$$\Delta_{\Psi} : u \mapsto e^{\Psi} \operatorname{div} \left( e^{-\Psi} \nabla u \right).$$

Section 2.2 is aimed to the investigation of an appropriate notion of *symmetric domain* and *symmetric function* that are suitable for our purpose. After a careful analysis of the literature, we have come to realize that the right candidates for the role of symmetric domains are the *isoparametric domains*. These are domains foliated by embedded submanifolds whose regular leaves (i.e. of maximal dimension) are parallel hypersurfaces with constant mean curvature. Isoparametric domains seems to be the right choice to settle our problem since they have a natural notion of *radial direction* (the one normal to the leaves of the foliation) and since their leaves display the same geometry.

As a trivial but illuminating example of isoparametric domain, we can consider the euclidean ball  $\mathbb{B}_r \subset \mathbb{R}^n$  foliated by concentric spheres.

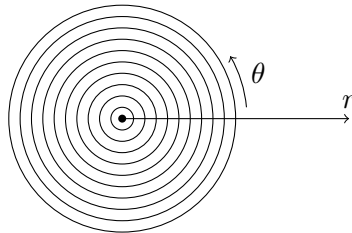

Using polar coordinates in  $\mathbb{R}^n$ , i.e. thinking to the Euclidean space as a warped product manifold, the direction normal to the leaves of the foliation is exactly the radial one. Moreover, this examples shows a fact that can be generalized to every isoparametric foliation: splitting the coordinates into a normal and a tangential (to the leaves) part, then the radial coordinate can be realized as the distance function from a possibly degenerate leaf of the foliation.

As a by-product of this investigation, we can say that a function  $u$  defined in an isoparametric domain  $\Omega$  is *symmetric* if it does not depend on the tangential coordinate, i.e. if it is constant on every leaf of the foliation of  $\Omega$ .

Once that the notion of symmetric domain and symmetric function have been chosen, the next step is to find a suitable assumption on the solution  $u$  to ensure that the symmetry of the domain is inherited by the function itself. For this purpose we opted for the notion

of *stability*, a spectral property that means that the spectrum of the linearized operator  $-\Delta + f'(u)$  is nonnegative. This choice has been suggested by the result obtained in [3] by N.D. Alikakos and P.W. Bates, where the authors show that in the Euclidean ball every stable solution to

$$\begin{cases} \Delta u = f(u) & \text{in } \mathbb{B}_r \\ u = 0 & \text{on } \partial\mathbb{B}_r \end{cases}$$

is symmetric.

Inspired by this very interesting result and by the fact that, as already seen, the Euclidean ball is an isoparametric domain, in Chapter 2 we generalize [3, Lemma 1.1] to certain classes of isoparametric Riemannian domains. The tools we adopt to prove the main theorems of this chapter come from potential theory. In particular, maximum principles (including that proved in Chapter 1) are the key ingredients.

The first symmetry result is about what we have called *homogeneous domains*, a particular class of isoparametric domains whose regular leaves are orbits of the action of the same subgroup of the isometry group of the ambient manifold  $M$ . The peculiarity of these domains consists in the fact that they are provided of a family  $\mathcal{D}$  of Killing vector fields whose integral submanifolds are (exactly) the regular leaves of the foliation. If the domain  $\Omega$  is compact and this family  $\mathcal{D}$  is *compatible* with the weight  $\Psi$  we are considering on the manifold, then we recover the following generalization of the result by Alikakos and Bates, whose proof is contained in Section 2.5. We stress that, thanks to the maximum principle of Theorem I.C, at the end of the same section we also manage to deal with the setting of noncompact isoparametric domains, under the additional assumption that the solution is strongly stable.

**Theorem I.E.** *Let  $\bar{\Omega}$  be a compact  $\Psi$ -homogeneous domain with soul  $P$  inside the weighted manifold  $M_\Psi$ . Moreover, assume that  $\Psi$  is symmetric (at least on  $\bar{\Omega}$ ) and denote with  $\mathcal{D} = \{X_1, \dots, X_k\}$  the integrable distribution of Killing vector fields associated to the foliation of  $\bar{\Omega}$ .*

*Then, any stable solution  $u \in C^3(\Omega) \cap C^1(\bar{\Omega})$  of*

$$\begin{cases} \Delta_\Psi u = f(u) & \text{in } \Omega \\ u = c_j & \text{on } (\partial\Omega)_j \end{cases}$$

*is symmetric.*

Clearly not all isoparametric domains have this plenty of isometries, hence to recover a symmetry result also in lack of enough Killing vector fields we must face the problem with a different approach. To this aim, we have to narrow it down to domains given by (possibly infinite) annuli in warped product manifolds with leaves of finite volume. This last assumption is needed to use some tools from the theory of *parabolic manifolds*. Whence, in Section 2.6 we obtain a symmetry result under stability with an additional (technical) assumption on the  $C^2$ -norm of the solution. This is the content of the next theorem where, for the sake of simplicity, we have considered only weights of the form  $\Psi(r, \xi) = \Phi(r) + \Gamma(\xi)$ , for  $(r, \xi) \in M = I \times_\sigma N$ .

**Theorem I.F.** Let  $M_\Psi = (I \times_\sigma N)_\Psi$  where  $(N, g^N)$  is a complete (possibly non-compact), connected,  $(m-1)$ -dimensional Riemannian manifold with finite  $\Gamma$ -volume  $\text{vol}_\Gamma(N) < +\infty$ .

Let  $u \in C^4(\bar{A}(r_1, r_2))$  be a solution to the Dirichlet problem

$$\begin{cases} \Delta_\Psi u = f(u) & \text{in } A(r_1, r_2) \\ u \equiv c_1 & \text{on } \{r_1\} \times N \\ u \equiv c_2 & \text{on } \{r_2\} \times N. \end{cases}$$

where  $c_j \in \mathbb{R}$  are given constants and  $f(t) \in C^2$  satisfies  $f''(t) \leq 0$ . If

$$\|u\|_{C_{rad}^2} := \sup_{A(r_1, r_2)} |u| + \sup_{A(r_1, r_2)} |\partial_r u| + \sup_{A(r_1, r_2)} |\partial_r^2 u| < +\infty,$$

and  $f'(u) \geq -B$ , for some constant  $B \geq 0$  satisfying

$$0 \leq B < \left( \int_{r_1}^{r_2} \frac{\int_{r_1}^s e^{-\Phi(z)} \sigma^{m-1}(z) \, dz}{e^{-\Phi(s)} \sigma^{m-1}(s)} \, ds \right)^{-1} \quad (\text{I.F.1})$$

then  $u(r, \xi) = \hat{u}(r)$  is symmetric.

As will be clearer in Chapter 2, the stability of the solution  $u$  is, in fact, hidden in the condition (I.F.1). Furthermore, at the end of the same chapter, we also present an alternative version of the previous theorem in which (I.F.1) is replaced with the strong stability of the solution and where warped product manifolds with parabolic leaves (having possibly infinite volume) are considered.

---

# Maximum Principles in unbounded Riemannian domains<sup>1</sup>

---

## 1.1 Maximum Principle in warped product manifolds

A celebrated maximum principle for unbounded domains in the Euclidean space states as follows

**Theorem 1.1.1.** *Consider a possibly unbounded domain  $\Omega \subset \mathbb{R}^n$ ,  $n \geq 2$ , whose closure is contained in the complement of a non-degenerate solid cone  $\mathcal{C} \subset \mathbb{R}^n$ . If  $u \in C^0(\bar{\Omega}) \cap W_{loc}^{1,2}(\Omega)$  is a distributional solution to*

$$\begin{cases} \Delta u - c u \geq 0 & \text{in } \Omega \\ u \leq 0 & \text{on } \partial\Omega \\ \sup_{\Omega} u < +\infty, \end{cases}$$

where  $0 \leq c \in C^0(\Omega)$ , then

$$u \leq 0 \quad \text{in } \Omega.$$

A possible proof makes use of the next classical lemma (see [10, Lemma 2.1]), which is based on the existence of a suitable positive  $(-\Delta + c)$ -subharmonic function. We state this result in a more general setting.

**Lemma 1.1.2.** *Let  $(M, g)$  be a complete manifold. Given a (possibly unbounded) domain  $\Omega \subset M$ , suppose  $u \in W_{loc}^{1,2}(\Omega) \cap C^0(\bar{\Omega})$  is a distributional solution to*

$$\begin{cases} \Delta u - c u \geq 0 & \text{in } \Omega \\ u \leq 0 & \text{on } \partial\Omega \\ \sup_{\Omega} u < +\infty, \end{cases}$$

---

<sup>1</sup>The content of this chapter is based on [16].

where  $0 \leq c \in C^0(\Omega)$ . If there exists a function  $\phi \in C^2(\Omega) \cap C^0(\bar{\Omega})$  (possibly depending on  $u$ ) satisfying

$$\begin{cases} \Delta\phi - c\phi \leq 0 & \text{in } \Omega \\ \phi > 0 & \text{in } \bar{\Omega} \end{cases}$$

and

$$\limsup_{\substack{d^M(p, p_0) \rightarrow +\infty \\ p \in \Omega}} \frac{u(p)}{\phi(p)} \leq 0$$

for any fixed  $p_0 \in \Omega$ , then  $u \leq 0$  in  $\Omega$ .

*Proof.* Let  $w := \frac{u}{\phi} \in W_{loc}^{1,2}(\Omega) \cap C^0(\bar{\Omega})$ : by the fact that  $u \in W_{loc}^{1,2}(\Omega)$  and  $\phi \in C^2(\Omega)$ , we get the distributional equality

$$\Delta u = w\Delta\phi + \phi\Delta w + 2g(\nabla w, \nabla\phi). \quad (1.1.1)$$

It follows that

$$\Delta w + 2g\left(\nabla w, \frac{\nabla\phi}{\phi}\right) + w\frac{\Delta\phi}{\phi} = \frac{\Delta u}{\phi} \geq c\frac{u}{\phi} = cw$$

i.e.

$$\mathcal{L}w := \Delta w + 2g\left(\nabla w, \frac{\nabla\phi}{\phi}\right) + w\frac{\Delta\phi - c\phi}{\phi} \geq 0.$$

By assumption, for any  $\epsilon > 0$  and any fixed  $p_0 \in M$  there exists  $0 < R_\epsilon \xrightarrow{\epsilon \rightarrow 0} \infty$  so that  $w(p) \leq \epsilon$  for every  $p \in \Omega$  satisfying  $d^M(p, p_0) \geq R_\epsilon$ . Hence, for  $\Omega_\epsilon := B_{R_\epsilon}^M(p_0) \cap \Omega$  we get

$$\begin{cases} \mathcal{L}w \geq 0 & \text{in any connected component of } \Omega_\epsilon \\ w \leq \epsilon & \text{on the boundary of any connected component of } \Omega_\epsilon. \end{cases}$$

Since  $\frac{\Delta\phi - c\phi}{\phi} \leq 0$ , by the standard maximum principle  $w \leq \epsilon$  in any connected component of  $\Omega_\epsilon$ . Letting  $\epsilon \rightarrow 0$  we get  $w \leq 0$  in  $\Omega$ , i.e.  $u \leq 0$  in  $\Omega$ .  $\square$

As said above, the previous lemma is the key ingredient to obtain the unbounded maximum principle already claimed. Indeed, for any bounded above supersolution  $u$  we just have to find a barrier function  $\phi$  satisfying the assumptions of Lemma 1.1.2. Observe that, since in Theorem 1.1.1  $u$  is assumed to be bounded above, the dependence of  $\phi$  on  $u$  may be bypassed just requiring that  $\phi \xrightarrow{|x| \rightarrow +\infty} +\infty$ .

It is precisely the presence of the cone  $\mathcal{C}$  in the complement of  $\Omega$  that allows us to easily construct  $\phi$ . Indeed, if we introduce the spherical coordinates  $(r, \theta)$  on  $\mathbb{R}^n$  and set  $\Lambda = \mathbb{S}^{n-1} \setminus \mathcal{C}$ , then  $\phi$  can be defined as the restriction to  $\Omega$  of the function  $\phi : (0, +\infty) \times \Lambda \rightarrow \mathbb{R}_{\geq 0}$  given by

$$\phi(r, \theta) = \begin{cases} \ln(r) + C_0 & \text{if } n = 2 \\ r^\alpha \psi(\theta) & \text{if } n \geq 3, \end{cases}$$



where  $\psi$  is the first Dirichlet eigenfunction of  $\Delta^{\mathbb{S}^{n-1}}|_{\Lambda}$  with associated first eigenvalue  $\lambda_1 > 0$  and  $\alpha \in \mathbb{R}$  satisfies the identity

$$\alpha(\alpha + n - 2) - \lambda_1 = 0.$$

By the nodal domain theorem, it follows that  $\phi > 0$  in  $\Omega$  and thus  $(\Delta - c)\phi \leq 0$ . Moreover, by construction,  $\phi$  diverges as  $|x| \rightarrow +\infty$ .

As one can easily verify, the previous construction is strongly based on the fact that the Euclidean space can be foliated by concentric spheres. More precisely, we have used that  $\mathbb{R}^n$  can be seen as a model manifold, that is, as the manifold obtained by quotienting the warped product  $([0, +\infty) \times \mathbb{S}^{n-1}, dr^2 + r^2 g^{\mathbb{S}^{n-1}})$  with respect to the relation that identifies  $\{0\} \times \mathbb{S}^{n-1}$  with a point  $o$ , called *pole*, and then extending smoothly the metric in  $o$ .

**Remark 1.1.3.** When we consider  $\mathbb{R}^n$  as a warped product manifold, the cone  $\mathcal{C}$  (whose vertex coincides with the pole  $o$ ) can be seen as a strip that extends along the "radial" direction.

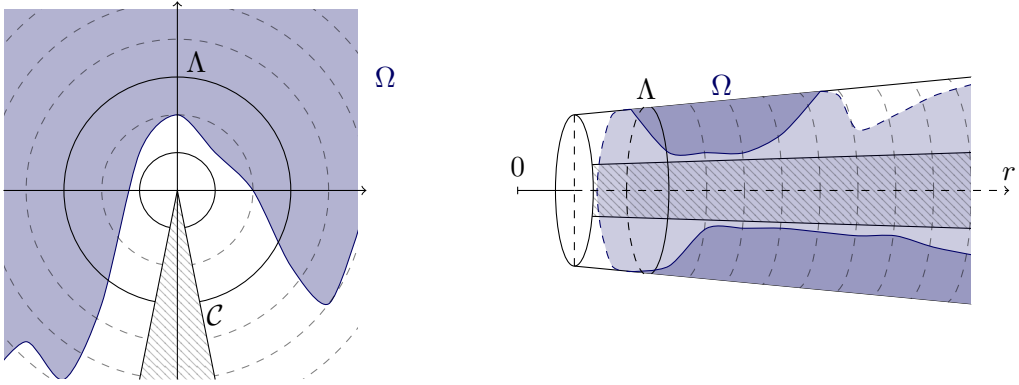

Using the viewpoint of warped product manifolds, a natural question could be the following

*Can we retrace what we have done so far to obtain a suitable barrier  $\phi$  on any warped product manifold  $M = I \times_{\sigma} N$ ?*

If we want to retrace the same construction step by step, we need the existence (and the positiveness) of the first eigenfunction  $\phi$  of  $\Delta^N|_{\Lambda}$ . This surely follows if the manifold  $N$  is compact. Whence, assuming that  $\phi$  takes the form  $\phi(r, \xi) = h(r)\psi(\xi)$  with  $\psi$  nonnegative first Dirichlet eigenfunction on a fixed subdomain  $\Lambda \subset N$ , by the structure of the Laplace-Beltrami operator acting on warped product manifolds, the inequality  $(-\Delta + c)\phi \geq 0$  reduces to

$$\partial_r^2 h + (n-1) \frac{\sigma'}{\sigma} \partial_r h - \left( \frac{\lambda_1}{\sigma^2} + c \right) h \leq 0 \quad (1.1.2)$$

and, in general, it is not easy to prove the existence of a positive solution to (1.1.2) that satisfies the asymptotic condition  $h \xrightarrow{r \rightarrow +\infty} +\infty$ . This means that we are able to generalize Theorem 1.1.1 only requiring strong assumptions on the manifold at hand.

### 1.1.1 $\mathcal{D}$ -parabolic manifolds

The fact that a Maximum Principle like the one claimed in Theorem 1.1.1 holds is strictly related to the property of a manifold to be parabolic. We recall the following standard definition

**Definition 1.1.4** (Dirichlet-parabolic manifold). *A Riemannian manifold  $(M, g)$  is said to be Dirichlet-parabolic (or  $\mathcal{D}$ -parabolic) if the unique bounded solution  $u \in C^0(\overline{\Omega}) \cap C^\infty(\Omega)$  to the problem*

$$\begin{cases} \Delta u = 0 & \text{in } \Omega \\ u = 0 & \text{on } \partial\Omega \end{cases}$$

*is the constant null function.*

Observe that in the definition of  $\mathcal{D}$ -parabolicity the boundary of the manifold (domain) at hand does not necessarily have to be smooth. Moreover, if the manifold has empty boundary, then the second condition in previous definition is void.

**Remark 1.1.5.** In Chapter 2 we present another definition of parabolicity for manifolds with boundary, i.e. the Neumann-parabolicity. It worth noting that the two notions are not equivalent. They agree if the manifold at hand has compact (for instance empty) boundary, but in general

$$\text{Neumann-parabolicity} \begin{matrix} \Rightarrow \\ \not\Leftarrow \end{matrix} \text{Dirichlet-parabolicity.}$$

A deep understanding of these topics and of its correlation has been carried out in [60] and in [79].

An interesting characterization of the parabolicity, that is useful in next section, can be provided in terms of the validity of the following Maximum Principle (see [79, Proposition 10]).

**Theorem 1.1.6** (Strong  $\mathcal{D}$ -Ahlfors Maximum Principle). *Given a Riemannian manifold  $M$  with boundary  $\partial M \neq \emptyset$ , the following are equivalent*

1.  $M$  is  $\mathcal{D}$ -parabolic;
2. for every bounded  $u \in C^0(M) \cap W_{loc}^{1,2}(M)$  s.t.  $\Delta u \geq 0$  in  $\text{int } M$  we have

$$\sup_M u = \sup_{\partial M} u$$

3. for every domain  $\Omega \subseteq M$  and every bounded  $u \in C^0(\Omega) \cap W_{loc}^{1,2}(\text{int } \Omega)$  s.t.  $\Delta u \geq 0$  in  $\text{int } \Omega$  we have

$$\sup_{\Omega} u = \sup_{\partial\Omega} u.$$

As it is clear from the previous characterization, the validity of a Maximum Principle on a domain  $\Omega$  can be easily reinterpreted in terms of its  $\mathcal{D}$ -parabolicity. Thanks to Theorem 1.1.1, we easily obtain

**Corollary 1.1.7.** *If  $\Omega \subset \mathbb{R}^n$ ,  $n \geq 2$ , is a (possibly unbounded) domain whose closure is contained in the complement of a non-degenerate solid cone  $\mathcal{C} \subset \mathbb{R}^n$ , then  $\Omega$  is  $\mathcal{D}$ -parabolic.*

*Proof.* Fixed any bounded function  $u \in C^0(\overline{\Omega}) \cap C^\infty(\Omega)$  satisfying

$$\begin{cases} \Delta u = 0 & \text{in } \Omega \\ u = 0 & \text{on } \partial\Omega, \end{cases}$$

by Theorem 1.1.1 we get  $u \leq 0$ . Applying the same argument to  $v = -u$ , it also follows that  $u \geq 0$ , obtaining  $u \equiv 0$ .  $\square$

### 1.1.2 $\mathcal{D}$ -parabolicity and Maximum Principle in warped products

In what follows, let  $M = \mathbb{R}_{\geq 0} \times_{\sigma} N$  be a warped product manifold, with  $\sigma : \mathbb{R}_{\geq 0} \rightarrow \mathbb{R}_{> 0}$  a positive smooth function and  $N$  a closed manifold. Observe that, up to double  $M$ , we can equivalently assume  $I = \mathbb{R}$  (and thus that the manifold is complete). Moreover, consider  $\Omega$  an unbounded domain whose closure is contained in the strip  $(0, +\infty) \times \Lambda$ , where  $\Lambda \subset N$  is a non-empty, connected open subset of  $N$  (with smooth boundary  $\partial\Lambda$ ) such that  $\overline{\Lambda} \neq N$ .

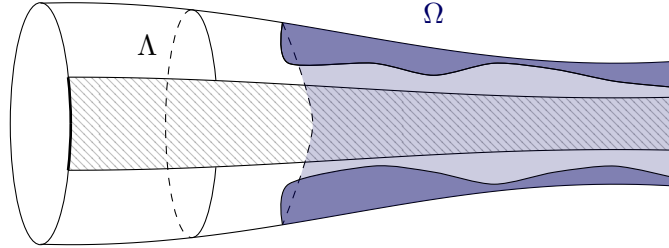

The aim of the present section is to extend Corollary 1.1.7 to unbounded domains contained in the complement of infinite strips inside warped product manifolds. This goal will be achieved using a slightly different approach with respect to the one adopted in the Euclidean case.

#### 1.1.2.1 $\mathcal{D}$ -parabolicity

While in Section 1.1.1 we explained how to prove  $\mathcal{D}$ -parabolicity of Euclidean domains using Lemma 1.1.2, for more general warped product manifolds we apply the following Dirichlet-Khas'minskii test (see [79, Lemma 14]) to subdomains of the ambient manifold.

**Lemma 1.1.8** ( *$\mathcal{D}$ -Khas'minskii test*). *Given a Riemannian manifold  $(M, g)$  with boundary  $\partial M \neq \emptyset$ , if there exists a compact set  $K \subset M$  and a function  $0 \leq \phi \in C^0(M \setminus \text{int } K) \cap W_{loc}^{1,2}(\text{int } M \setminus K)$  such that  $\phi(x) \rightarrow \infty$  as  $d^M(x, x_0) \rightarrow \infty$  for some (any)  $x_0 \in M$ , and*

$$-\int_{\text{int } M \setminus K} g(\nabla \phi, \nabla \rho) \, dv \leq 0 \quad \forall 0 \leq \rho \in C^0(M \setminus \text{int } K) \cap W_{loc}^{1,2}(\text{int } M \setminus K),$$

then  $M$  is  $\mathcal{D}$ -parabolic.

Before stating the main theorem of this section we briefly recall that the radial Ricci curvature  $\text{Ric}_{rr}$  at a point  $p = (r, \xi)$  of a warped product manifold  $M = I \times_\sigma N$  is given by

$$\text{Ric}_{rr}(p) = \text{Ric} \left( \frac{\partial}{\partial r}, \frac{\partial}{\partial r} \right) (p) = -\frac{\sigma''(r)}{\sigma(r)}.$$

In particular, on noting that  $\sigma(r) > 0$  for every  $r \in I$ , we get

$$\text{Ric}_{rr}(p) \geq 0 \quad (\text{resp. } \leq 0) \quad \Leftrightarrow \quad \sigma''(r) \leq 0 \quad (\text{resp. } \geq 0).$$

**Theorem 1.1.9.** *Let  $M = \mathbb{R}_{\geq 0} \times_\sigma N$  be a warped product manifold of dimension  $\dim(M) \geq 2$ , where  $\sigma : \mathbb{R}_{\geq 0} \rightarrow \mathbb{R}_{> 0}$  is a smooth function and  $N$  is a closed manifold. Consider  $\Omega \subset M$  an unbounded domain whose closure is contained in the strip  $[0, +\infty) \times \Lambda$ , where  $\Lambda \subset N$  is a non-empty, smooth and connected open subset of  $N$  such that  $\overline{\Lambda} \neq N$ . Assume that either one of the following conditions is satisfied*

1.  $\text{Ric}_{rr} \leq 0$  eventually and  $\lim_{r \rightarrow \infty} \sigma(r) = c \in [0, +\infty)$ ;
2.  $\text{Ric}_{rr} \geq 0$  eventually and  $\lim_{r \rightarrow \infty} \sigma(r) = c \in (0, +\infty)$ ;
3.  $\sigma \in O(r^\beta)$  for  $0 < \beta < \frac{1}{2}$  as  $r \rightarrow +\infty$  and  $\frac{\sigma'}{\sigma} \in L^\infty(+\infty)$ .

Then  $\overline{\Omega}$  is  $\mathcal{D}$ -parabolic.

*Proof.* We recall that  $\Omega$  is  $\mathcal{D}$ -parabolic if every  $u \in C^\infty(\Omega) \cap C^0(\overline{\Omega}) \cap L^\infty(\Omega)$  satisfying the Dirichlet problem

$$\begin{cases} \Delta u = 0 & \text{in } \Omega \\ u = 0 & \text{on } \partial\Omega \end{cases} \quad (1.1.3)$$

vanishes everywhere. By the invariance of  $\mathcal{D}$ -parabolicity by removing compact domains, it is enough to prove that there exists an appropriate compact subset  $K \subset \Omega$  such that the resulting subdomain  $U := \Omega \setminus K$  is  $\mathcal{D}$ -parabolic. To this end, in turn, following the philosophy of Khas'minskii test, we only have to find a nonnegative function  $\phi \in C^0(\overline{U}) \cap W_{loc}^{1,2}(U)$  satisfying the conditions

$$\begin{cases} \Delta \phi \leq 0 \\ \lim_{\substack{d^M(p_0, x) \rightarrow \infty \\ x \in \Omega}} \phi(x) = +\infty \end{cases}$$

for any fixed  $p_0 \in M$ . Indeed, in this case given any solution  $u \in C^\infty(U) \cap C^0(\bar{U}) \cap L^\infty(U)$  of (1.1.3), suppose by contradiction that  $\sup_U u > 0$ . Then there exists  $x_0, x_1 \in U$  such that  $\sup_U u \geq u(x_1) > u(x_0) =: u_0 > 0$ . Define  $v := u - u_0 - \epsilon\phi$ , for  $\epsilon$  small enough so that  $v(x_1) > 0$ , and set  $W := \{x \in U : v(x) > 0\}$ . Then  $x_1 \in W$  and  $W$  is bounded since  $\phi \rightarrow +\infty$  as  $d^M(p_0, x) \rightarrow \infty$ . By the fact that  $\Delta v \geq 0$  weakly in  $W$  and  $v \leq 0$  on  $\partial W$ , using the strong maximum principle we get  $v \leq 0$  on  $W$ , thus obtaining a contradiction. It follows that  $u \leq 0$ . By applying the same argument to the function  $-u$ , we conclude  $u \equiv 0$ , as desired.

It remains to prove the existence of the function  $\phi$  and the corresponding compact set  $K$ . Thanks to the structure of the warped product manifold, we can assume  $\phi$  to be of the form  $\phi(r, \xi) = h(r)\psi(\xi)$ . So, let  $\psi$  be the positive first Dirichlet eigenfunction of the Laplacian on  $\Lambda$

$$\begin{cases} -\Delta^\Lambda \psi = \lambda_1 \psi \geq 0 & \text{in } \Lambda \\ \psi = 0 & \text{on } \partial\Lambda. \end{cases}$$

With this choice the differential inequality  $\Delta\phi \leq 0$  is equivalent to the second order ODE

$$h'' + (m-1)\frac{\sigma'}{\sigma}h' - \frac{1}{\sigma^2}\lambda_1 h \leq 0. \quad (1.1.4)$$

Whence, we are reduced to find a solution  $h$  to (1.1.4). This is obtained via a case by case analysis:

1.  $\sigma'' \geq 0$  eventually and  $\exists \lim_{r \rightarrow \infty} \sigma(r) = c \in [0, +\infty)$ : by assumption, there exists  $A \geq 1$  so that

$$\sigma'' \geq 0 \quad \text{and thus} \quad \sigma \geq c$$

in  $[A, +\infty)$ . This implies that  $\sigma' \xrightarrow{r \rightarrow +\infty} C \leq 0$  and  $\sigma' \leq 0$  eventually, so we can assume that  $\sigma' \leq 0$  for  $r \geq A$ .

Let  $h(r) := r$ , defined in  $[A, +\infty)$ : since  $h' = 1 \geq 0$ ,  $h'' = 0$  and  $\sigma' \leq 0$ , we get

$$h'' + (m-1)\frac{\sigma'}{\sigma}h' - \frac{1}{\sigma^2}\lambda_1 h \leq 0.$$

By construction,  $h(r) \xrightarrow{r \rightarrow +\infty} +\infty$  and  $h(r) > 0$  in  $[A, +\infty)$ . Whence, defining  $U := \Omega \cap ([A, +\infty) \times N)$  and taking  $\phi(r, \xi) = h(r)\psi(\xi)$ , by the previous argument we obtain that  $U$  is  $\mathcal{D}$ -parabolic.

- 2.a.  $\sigma'' \leq 0$  eventually and  $\exists \lim_{r \rightarrow \infty} \sigma(r) = c \in (0, +\infty)$ : as in previous case, there exists  $A \geq 1$  so that

$$\sigma'' \leq 0 \quad \text{and thus} \quad \sigma \leq c$$

in  $[A, +\infty)$ , implying (w.l.o.g.)  $0 \leq \sigma' \leq E < +\infty$  in  $[A, +\infty)$  for a positive constant  $E$ . Let  $\beta \in (0, 1)$  and  $h(r) := r^\beta$ : we get

$$\begin{aligned} h'' + (m-1)\frac{\sigma'}{\sigma}h' - \frac{1}{\sigma^2}\lambda_1 h &= \beta(\beta-1)r^{\beta-2} + (m-1)\frac{\sigma'}{\sigma}\beta r^{\beta-1} - \frac{1}{\sigma^2}\lambda_1 r^\beta \\ &\leq (m-1)\frac{\sigma'}{\sigma}\beta r^{\beta-1} - \frac{1}{\sigma^2}\lambda_1 r^\beta \\ &\leq (m-1)\frac{E}{\sigma}\beta r^{\beta-1} - \frac{1}{\sigma^2}\lambda_1 r^\beta \\ &= \frac{r^\beta}{\sigma} \left[ (m-1)\frac{E}{r}\beta - \frac{1}{\sigma}\lambda_1 \right] \\ &\leq \frac{r^\beta}{\sigma} \left[ (m-1)E\beta - \frac{1}{c}\lambda_1 \right] \end{aligned}$$

and, choosing  $\beta \in (0, 1)$  so that  $\left[ (m-1)E\beta - \frac{1}{c}\lambda_1 \right] \leq 0$ , we obtain

$$h'' + (m-1)\frac{\sigma'}{\sigma}h' - \frac{1}{\sigma^2}\lambda_1 h \leq 0.$$

Since  $h$  is positive and diverges as  $r \rightarrow +\infty$ , we can proceed exactly as in previous case, obtaining that  $U := \Omega \cap ([A, +\infty) \times N)$  is  $\mathcal{D}$ -parabolic.

- 2.b.  $\sigma'' \leq 0$  eventually and  $\exists \lim_{r \rightarrow +\infty} \sigma(r) = +\infty$ : by assumption, there exists  $A > 1$  so that  $\sigma'' \leq 0$  in  $[A, +\infty)$ . Together with the fact that  $\sigma \rightarrow +\infty$  as  $r \rightarrow +\infty$ , this implies that  $\sigma'$  is nonincreasing and eventually positive. In particular,  $\sigma' \leq E$  is bounded in  $[A, +\infty)$ . Choosing  $h(r) = \sigma^\beta(r)$  for  $\beta > 0$ , we get

$$\begin{aligned} h'' + (m-1)\frac{\sigma'}{\sigma}h' - \frac{1}{\sigma^2}\lambda_1 h &= \beta(\sigma')^2\sigma^{\beta-2}(\beta+m-2) + \beta\sigma^{\beta-1}\sigma'' - \lambda_1\sigma^{\beta-2} \\ &= \sigma^{\beta-2} \left[ (\sigma')^2\beta(\beta+m-2) - \lambda_1 \right] + \underbrace{\beta\sigma^{\beta-1}\sigma''}_{\leq 0} \end{aligned}$$

in  $[A, +\infty)$  and, thanks to the boundedness of  $\sigma'$ , we can take a positive  $\beta$  small enough so that

$$(\sigma')^2\beta(\beta+m-2) - \lambda_1 \leq 0,$$

obtaining

$$h'' + (m-1)\frac{\sigma'}{\sigma}h' - \frac{1}{\sigma^2}\lambda_1 h \leq 0$$

in  $[A, +\infty)$ . As in first case, it follows that the subdomain  $U := \Omega \cap ([A, +\infty) \times N)$  is  $\mathcal{D}$ -parabolic.

3.  $\sigma \in O(r^\beta)$  for  $0 < \beta < \frac{1}{2}$  as  $r \rightarrow \infty$  and  $\frac{\sigma'}{\sigma} \in L^\infty$  eventually: let  $E > 0$  and  $A_0 > 0$  so that  $\frac{\sigma'}{\sigma} < E$  in  $[A_0, +\infty)$ . Then, under the current assumptions, the function

$h(r) := r$  satisfies

$$\begin{aligned} h'' + (m-1)\frac{\sigma'}{\sigma}h' - \frac{1}{\sigma^2}\lambda_1 h &= (m-1)\overbrace{\frac{\sigma'}{\sigma}}^{<E} - \frac{1}{\sigma^2}\lambda_1 r \\ &< (m-1)E - \frac{1}{\sigma^2}\lambda_1 r \xrightarrow{r \rightarrow +\infty} -\infty \end{aligned}$$

implying that there exists  $A > A_0$  so that equation (1.1.4) is satisfied in  $[A, +\infty)$ . Again, it follows that the domain  $U := \Omega \cap ([A, +\infty) \times N)$  is  $\mathcal{D}$ -parabolic.

As a consequence of the above analysis, we get a  $\mathcal{D}$ -parabolic subdomain of the form  $U := \Omega \cap ([A, +\infty) \times N)$ , for  $A > 0$  big enough.

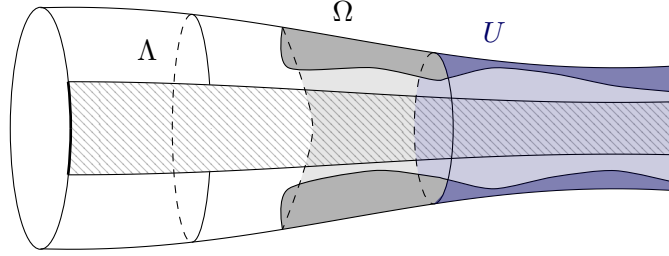

Since  $\Omega \setminus U = ([0, A] \times N) \cap \Omega$  is compact in  $\Omega$  and  $U$  is  $\mathcal{D}$ -parabolic, by [79, Corollary 11] the domain  $\Omega$  is itself  $\mathcal{D}$ -parabolic, thus completing the proof.  $\square$

We emphasize that in condition 1 in Theorem 1.1.9 the existence of the limit as  $r \rightarrow +\infty$  is implied by the convexity of  $\sigma$  (recall:  $\text{Ric}_{rr} \leq 0$  if and only if  $\sigma'' \geq 0$ ). Thus, the finiteness of the limit implies that the manifold is essentially a cylinder. Moreover, we can observe that condition 1 cannot be extended to the case

$$\text{Ric}_{rr} \leq 0 \text{ eventually and } \lim_{r \rightarrow \infty} \sigma(r) = +\infty.$$

Indeed, in this case we are able to construct a (non-smooth) domain  $\Omega$  and a bounded subharmonic function  $u$  so that

$$\sup_{\Omega} u \neq \sup_{\partial\Omega} u.$$

This, thanks to Theorem 1.1.6, implies that  $\Omega$  is not  $\mathcal{D}$ -parabolic.

The construction is obtained by considering  $M = \mathbb{R}_{\geq 0} \times_{\sigma} N$ , where

- $N$  is a closed manifold;
- $\sigma : [0, +\infty) \rightarrow (0, +\infty)$  is so that

$$\sigma(r) = r^{3/2} \quad \text{in } [1, +\infty);$$

and the domain  $\Omega$  is defined as  $\Omega = [A, +\infty) \times_{\sigma} \Lambda$ , for  $A > 2$  to be fixed and  $\Lambda \Subset N$  a non-empty, smooth and connected open subset of  $N$  such that  $\bar{\Lambda} \neq N$ . The function  $u$  is given by

$$u(r, \xi) := h(r)\varphi(\xi)$$

where  $\varphi$  is the positive first Dirichlet eigenfunction (with associated first eigenvalue  $\lambda_1$ ) of the Laplacian on  $\Lambda$  and  $h(r) = A^{-1} - r^{-1}$ . In particular,

$$\begin{aligned} \Delta u(r, \xi) &= \varphi(\xi) \left( h''(r) + (m-1) \frac{\sigma'(r)}{\sigma(r)} h'(r) - \lambda_1 \frac{1}{\sigma^2(r)} h(r) \right) \\ &= \varphi(\xi) r^{-3} \left( -2 + (m-1) \frac{3}{2} - \lambda_1 A^{-1} + \lambda_1 r^{-1} \right) \end{aligned}$$

that is nonnegative if  $m \geq 3$  and  $A > 0$  is big enough so that

$$(m-1) \frac{3}{2} > 2 + \lambda_1 A^{-1}.$$

Hence, with this choice,  $\Delta u \geq 0$  and

$$\sup_{\Omega} u > 0 = \sup_{\partial\Omega} u.$$

This counterexample closes the picture for the case  $\text{Ric}_{rr} \leq 0$ , proving that we have  $\mathcal{D}$ -parabolicity of such domains if and only if the manifold is (asymptotically) a cylinder.

Similarly, in condition 2 the assumptions considered on  $\sigma$  are sufficient to ensure the existence of the limit of  $\sigma$  as  $r \rightarrow +\infty$ . This follows from the fact that the concavity and the positivity of the warping function imply that  $\sigma$  has to be eventually non-decreasing. Indeed, if  $\sigma'' \geq 0$  in  $[A, +\infty)$ , fixed any  $y > x > A$  and defined  $z_t = \frac{y-tx}{1-t}$  for  $t \in (0, 1)$ , thanks to the concavity and to the positivity of  $\sigma$

$$\sigma(y) = \sigma(tx + (1-t)z_t) \geq t\sigma(x) + (1-t)\sigma(z_t) \geq t\sigma(x)$$

that implies, as  $t \rightarrow 1$ ,  $\sigma(y) \geq \sigma(x)$ .

### 1.1.2.2 Maximum Principle

A direct application of Theorem 1.1.9 gives the following maximum principle for unbounded domains. Its proof is based on a characterization of the  $\mathcal{D}$ -parabolicity contained in Theorem 1.1.6, which asserts that a Riemannian manifold  $X$  with nonempty boundary  $\partial X \neq \emptyset$  is  $\mathcal{D}$ -parabolic if and only if every bounded subharmonic function  $u \in C^0(X) \cap W_{loc}^{1,2}(\text{int } X)$  satisfies  $\sup_X u = \sup_{\partial X} u$ .

**Theorem 1.1.10** (Unbounded maximum principle). *Let  $M = \mathbb{R}_{\geq 0} \times_{\sigma} N$  be a warped product manifold of dimension  $\dim(M) \geq 2$ , where  $\sigma : \mathbb{R}_{\geq 0} \rightarrow \mathbb{R}_{> 0}$  is a smooth function and  $N$  a closed manifold. Consider  $\Omega \subset M$  an unbounded domain whose closure is contained in the strip  $[0, +\infty) \times \Lambda$ , where  $\Lambda \subset N$  is a non-empty, smooth and connected open subset of  $N$  such that  $\bar{\Lambda} \neq N$ . Moreover, suppose the validity of either one of the following conditions*



1.  $\text{Ric}_{rr} \leq 0$  eventually and  $\lim_{r \rightarrow \infty} \sigma(r) = c \in [0, +\infty)$ ;
2.  $\text{Ric}_{rr} \geq 0$  eventually and  $\lim_{r \rightarrow \infty} \sigma(r) = c \in (0, +\infty]$ ;
3.  $\sigma \in O(r^\beta)$  for  $0 < \beta < \frac{1}{2}$  as  $r \rightarrow \infty$  and  $\frac{\sigma'}{\sigma} \in L^\infty(+\infty)$ .

If  $u \in C^0(\overline{\Omega}) \cap W_{loc}^{1,2}(\Omega)$  is a bounded above distributional solution to the problem

$$\begin{cases} \Delta u - c u \geq 0 & \text{in } \Omega \\ u \leq 0 & \text{on } \partial\Omega, \end{cases}$$

where  $0 \leq c \in C^0(\Omega)$ , then  $u \leq 0$  in  $\Omega$ .

*Proof.* Consider  $u \in C^0(\overline{\Omega}) \cap W_{loc}^{1,2}(\Omega)$  a bounded above distributional solution to the problem

$$\begin{cases} \Delta u - c u \geq 0 & \text{in } \Omega \\ u \leq 0 & \text{on } \partial\Omega. \end{cases}$$

If  $u^+ := \max\{u, 0\}$ , by Brezis-Kato's inequality (see [87, Proposition A.1]) we get

$$\begin{cases} \Delta u^+ \geq c u^+ \geq 0 & \text{in } \Omega \\ u^+ = 0 & \text{on } \partial\Omega. \end{cases}$$

Using Theorem 1.1.9 and Theorem 1.1.6 it follows that  $u^+ = 0$  in  $\Omega$ , implying  $u \leq 0$  in  $\Omega$ .  $\square$

## 1.2 Maximum Principle via an Alexandroff-Bakelman-Pucci estimate

### 1.2.1 ABP inequality

In the very interesting article [25], Cabré proved a Riemannian version of the Alexandroff-Bakelman-Pucci estimate for elliptic operators in nondivergent form acting on manifolds with nonnegative sectional curvature. In his work, he used the assumption on the sectional curvature to ensure two fundamental tools: the (global) volume doubling property for the Riemannian measure  $dv$  and the classical Hessian comparison principle by Rauch. In particular, since these two tools (with different curvature bounds) are available in every relatively compact domain  $\Omega \subset M$  regardless of any assumption on the sectional curvature of  $M$ , it is reasonable to expect that we can locally recover the results by Cabré up to multiply by appropriate constants depending on  $\Omega$  and on the lower bound of its sectional curvature.

Among its various applications, the ABP inequality is one of the main ingredients used by Berestycki, Nirenberg and Varadhan in [11] to prove the existence of the *generalized principal eigenfunction* of a second order differential operator  $\mathcal{L}$  on Euclidean domains, that is, a generalization of the notion of eigenfunction to operators acting on possibly

nonsmooth or unbounded domains. Our aim is to transplant the construction of the generalized principal eigenfunction into general bounded (and into smooth unbounded) Riemannian domains: this will allow us to prove a maximum principle for uniformly elliptic second order differential operators acting on smooth unbounded domains.

Following the proof in [25], we get a version of the ABP inequality for uniformly elliptic operators of the form

$$\mathcal{L}u(x) := \mathcal{M}u(x) + c(x)u(x), \quad (1.2.1)$$

with

$$\mathcal{M}u(x) := \operatorname{div}(A(x) \cdot \nabla u(x)) + g(B(x), \nabla u(x)),$$

acting on a bounded Riemannian domain  $\Omega \subset M$ , where  $c \in C^0(M)$  is a continuous function,  $B \in C^\infty(M; TM)$  is a smooth vector field and  $A \in \operatorname{End}(TM)$  is a positive definite, smooth and symmetric endomorphism of the tangent bundle  $TM$  so that

$$c_0 g(\xi, \xi) \leq g(A(x) \cdot \xi, \xi) \leq C_0 g(\xi, \xi) \quad \forall x \in M, \forall \xi \in T_x M,$$

for some positive constants  $c_0$  and  $C_0$ . Moreover, we assume that the local coefficients  $a_i^j$  of the endomorphism  $A$  satisfy

$$\|a_i^j\|_{C^1} \leq a \quad \forall i, j, \quad (1.2.2)$$

where  $a \in \mathbb{R}_{>0}$ .

The strategy we adopt to achieve the ABP inequality is strongly based on the existence of a suitable atlas composed by harmonic charts. To this aim, let's start by introducing the following definition.

**Definition 1.2.1** (Harmonic radius). *Given an  $n$ -dimensional Riemannian manifold  $(M, g)$ , the  $C^1$ -harmonic radius of  $M$  at  $x \in M$ , denoted by  $r_h(x)$ , is the supremum among all  $R > 0$  so that there exists a coordinate chart  $\phi : B_R(x) \rightarrow \mathbb{R}^n$  with the following properties*

- (i)  $2^{-1}g^{\mathbb{R}^n} \leq g \leq 2g^{\mathbb{R}^n}$  in the local chart  $(B_R(x), \phi)$ ;
- (ii)  $\|\partial_k g_{ij}\|_{C^0(B_R(x))} \leq \frac{1}{R}$  for every  $i, j, k$ ;
- (iii)  $\phi$  is an harmonic map.

Defining  $r_h(M) := \inf_{x \in M} r_h(x)$ , if we suppose that

$$|\operatorname{Ric}| \leq K \quad \text{and} \quad \operatorname{inj}_{(M, g)} \geq i \quad (1.2.3)$$

for some constants  $K, i \in \mathbb{R}_{>0}$ , by [55, Corollary] it follows that there exists a constant  $r_0 = r_0(n, K, i) > 0$  so that

$$r_h(M) \geq r_0.$$

In particular, under the assumptions (1.2.3) we can choose a cover of harmonic charts (with fixed positive radius) providing a uniform  $C^1$ -control on the metric and on its derivatives. We will use the existence of a positive harmonic radius in the proof of the next Alexandroff-Bakelman-Pucci inequality, one of the main results of the present section.

**Theorem 1.2.2.** *Let  $(M, g)$  be a complete Riemannian manifold of dimension  $\dim(M) = n$ ,  $\Omega \Subset M$  a bounded smooth domain and  $f \in L^n(\Omega)$ . Denote  $\Omega_r := \{x \in M : d(x, \Omega) < r\}$  for  $r > 0$ . Let  $b > 0$  so that  $|B|, |c| \leq b$  in an open neighbourhood of  $\Omega$ .*

*Then, there exists a positive constant  $C = C(n, a, b, c_0, C_0, r_h(\bar{\Omega}), |\Omega|, |\Omega_{r_h(\bar{\Omega})}|)$  such that for every  $u \in C^2(\Omega)$  satisfying*

$$\begin{cases} \mathcal{M}u \geq f & \text{in } \Omega \\ \limsup_{x \rightarrow \partial\Omega} u(x) \leq 0, \end{cases}$$

*it holds*

$$\sup_{\Omega} u \leq C \operatorname{diam}(\Omega) \|f\|_{L^n(\Omega)}. \quad (1.2.4)$$

The key result we need to prove Theorem 1.2.2 is the following Euclidean integral Harnack inequality, whose proof can be found in [41, Theorem 9.22].

**Theorem 1.2.3.** *Let  $\mathcal{L} := a^{ij}\partial_i\partial_j + b^i\partial_i + c$  be an uniformly elliptic differential operator acting on a bounded domain  $U \subset \mathbb{R}^n$  with*

$$c_0 \leq [a^{ij}] \leq C_0 \quad \text{and} \quad |b^i\partial_i|, |c| \leq b,$$

*for some positive constants  $c_0, C_0$  and  $b$ , and let  $f \in L^n(U)$ . If  $u \in W^{2,n}(U)$  satisfies  $\mathcal{L}u \leq f$  and is nonnegative in a ball  $B_{2R}(z) \subset U$ , then*

$$\left( \int_{B_R(z)} u^p \right)^{\frac{1}{p}} \leq C_1 \left( \inf_{B_R(z)} u + R \|f\|_{L^n(B_{2R}(z))} \right),$$

*where  $p$  and  $C_1$  are positive constants depending on  $n, bR, c_0$  and  $C_0$ .*

**Remark 1.2.4.** If  $b = 0$ , i.e. if  $B$  is the null vector field and  $c \equiv 0$ , then the constants  $p$  and  $C_1$  in previous theorem do not depend on the radius  $R$ .

**Remark 1.2.5.** If  $\Omega$  is a bounded smooth domain and  $u \in C^2(\Omega) \cap C^1(\bar{\Omega})$  satisfies

$$\begin{cases} \mathcal{M}u \leq f & \text{in } \Omega \\ u \equiv C & \text{on } \partial\Omega \\ \frac{\partial u}{\partial A \cdot \nu} \leq 0 & \text{on } \partial\Omega, \end{cases}$$

where  $\nu$  is the outward pointing unit vector field normal to  $\partial\Omega$ , then we can consider a larger bounded smooth domain  $\Lambda \ni \Omega$  and we can extend  $u$  and  $f$  to  $\Lambda$  by imposing  $u \equiv C$  and  $f \equiv 0$  in  $\Lambda \setminus \bar{\Omega}$ . In this way we get a function  $u \in C^0(\Lambda) \cap W^{2,n}(\Lambda)$  satisfying  $\mathcal{M}u \leq f$  weakly in  $\Lambda$ , i.e. so that

$$\int_{\Lambda} [-g(A \cdot \nabla u, \nabla \phi) + g(B, \nabla u)\phi] \, dv \leq \int_{\Lambda} f\phi \, dv \quad \forall 0 \leq \phi \in C_c^\infty(\Lambda).$$

**Remark 1.2.6.** We stress that if  $\Omega$  is a bounded smooth domain,  $u \in C^2(\Omega) \cap C^1(\bar{\Omega})$  satisfies

$$\begin{cases} \mathcal{M}u \leq 0 & \text{in } \Omega \\ u \equiv C & \text{on } \partial\Omega \end{cases}$$

and  $x_0 \in \partial\Omega$  is a global minimum for  $u$  in  $\bar{\Omega}$ , then

$$\frac{\partial u}{\partial A \cdot \nu}(x_0) \leq 0.$$

Indeed, by decomposing  $A \cdot \nu = (A \cdot \nu)^\top + (A \cdot \nu)^\perp$ , where  $(A \cdot \nu)^\top$  and  $(A \cdot \nu)^\perp$  are tangential and normal to  $\partial\Omega$  respectively, one can check that

$$\frac{\partial u}{\partial A \cdot \nu}(x_0) = (A(x_0) \cdot \nu(x_0))^\perp \frac{\partial u}{\partial \nu}(x_0) = \underbrace{g(A(x_0) \cdot \nu(x_0), \nu(x_0))}_{>0} \frac{\partial u}{\partial \nu}(x_0)$$

where the first equality follows from the fact that  $x_0 \in \partial\Omega$  is a minimum for  $u|_{\partial\Omega}$ , implying that the tangential component (to  $\partial\Omega$ ) of  $\nabla u$  vanishes at  $x_0$ . Hence  $\frac{\partial u}{\partial A \cdot \nu}(x_0)$  and  $\frac{\partial u}{\partial \nu}(x_0)$  have the same sign. By standard Hopf's Lemma it follows that  $\frac{\partial u}{\partial A \cdot \nu}(x_0) \leq 0$ .

**Remark 1.2.7.** Using the local expression of the differential operator  $\mathcal{M}$ , we can estimate the constant of Theorem 1.2.3 in every local chart in terms of the coefficients  $A, B$  and  $c$  and of the first order derivatives of the metric, i.e. in terms of the harmonic radius of  $M$  thanks to condition (ii). Indeed, if  $X$  is a vector field, in local coordinates

$$\operatorname{div}(X) = \frac{\partial X^k}{\partial x^k} + X^t \Gamma_{kt}^k$$

obtaining

$$\begin{aligned} \operatorname{div}(A \cdot \nabla u) &= \operatorname{div} \left( a_i^j \frac{\partial}{\partial x^j} \otimes dx^i \left[ g^{hk} \frac{\partial u}{\partial x^k} \frac{\partial}{\partial x^h} \right] \right) \\ &= \frac{\partial}{\partial x^j} \left( a_i^j g^{hi} \frac{\partial u}{\partial x^h} \right) + a_i^t g^{hi} \frac{\partial u}{\partial x^h} \Gamma_{kt}^k. \end{aligned}$$

Hence the differential operator  $\mathcal{M}$  writes as

$$\begin{aligned} \mathcal{M}u &= \operatorname{div}(A \cdot \nabla u) + g(B, \nabla u) \\ &= \operatorname{div} \left( a_i^j \frac{\partial}{\partial x^j} \otimes dx^i \left[ g^{hk} \frac{\partial u}{\partial x^k} \frac{\partial}{\partial x^h} \right] \right) + g \left( B^j \frac{\partial}{\partial x^j}, g^{hk} \frac{\partial u}{\partial x^k} \frac{\partial}{\partial x^h} \right) \\ &= \frac{\partial}{\partial x^j} \left( a_i^j g^{hi} \frac{\partial u}{\partial x^h} \right) + a_i^t g^{hi} \frac{\partial u}{\partial x^h} \Gamma_{kt}^k + B^k \frac{\partial u}{\partial x^k} \\ &= a_i^j g^{hi} \frac{\partial^2 u}{\partial x^j \partial x^h} + \left( \frac{\partial}{\partial x^j} (a_i^j g^{ki}) + a_i^t g^{ki} \Gamma_{ht}^h + B^k \right) \frac{\partial u}{\partial x^k}. \end{aligned}$$

As a consequence, fixed a bounded domain  $\Omega \subset M$ , if we consider  $b > 0$  so that

$$|B| \leq b \quad \text{and} \quad |c| \leq b$$

in an open neighbourhood  $U$  of  $\Omega$ , then under the assumptions (1.2.3) the coefficients of  $\mathcal{M}$  have the same bounds in every harmonic chart contained in  $U$ . In particular, in Theorem 1.2.3 we can choose the same constants  $p = p(n, r_h(M), a, b, c_0, C_0)$  and  $C = C(n, r_h(M), a, b, c_0, C_0)$  for every harmonic chart, avoiding any dependence on the local chart.

Lastly, we stress that if we consider an operator of the form

$$\mathcal{M}(u) = \operatorname{tr}(A \cdot \operatorname{Hess}(u)) + g(B, \nabla u),$$

then the same conclusion holds true without requiring the condition (1.2.2).

*Proof of Theorem 1.2.2.* We start by supposing that  $u$  is smooth up to the boundary of  $\Omega$ . Consider the solution  $w$  of the problem

$$\begin{cases} \mathcal{M}w = -F := -(\mathcal{M}u)^- \leq 0 & \text{in } \Omega \\ w = 0 & \text{on } \partial\Omega. \end{cases}$$

By assumption,  $u \in C^\infty(\bar{\Omega})$  and so  $F = (\mathcal{M}u)^-$  is Lipschitz in  $\bar{\Omega}$ , implying that  $w \in C^{2,\alpha}(\bar{\Omega})$  for any  $\alpha \in (0, 1)$ . Moreover, by the standard maximum principle, we have  $w \geq 0$ . Now consider the function  $w - u$ : by definition

$$\begin{cases} \mathcal{M}(w - u) \leq 0 & \text{in } \Omega \\ w - u \geq 0 & \text{on } \partial\Omega \end{cases}$$

and, again by standard maximum principle,

$$w \geq u \quad \text{in } \Omega.$$

Take  $z_0 \in \Omega$  so that  $S = w(z_0) = \sup_{\Omega} w > 0$  and consider the function  $v := S - w \geq 0$ . Let  $r := r_h(\bar{\Omega})$  and consider the  $r$ -neighbourhood  $\Omega_r$  of  $\Omega$

$$\Omega_r := \{x \in M : d(x, \Omega) < r\}.$$

Since  $v|_{\partial\Omega} \equiv S$ , by Remark 1.2.6, we can extend  $v$  and  $F$  to  $\Omega_r$  as done in Remark 1.2.5.

Observe that, without loss of generality, we can suppose  $\operatorname{diam}(\Omega) \geq r$ . Otherwise,  $\Omega$  is contained in an harmonic local chart and the theorem follows by the standard Euclidean ABP inequality.

Consider an open cover  $\mathcal{W}$  of  $\bar{\Omega}$  given by

$$\mathcal{W} := \{(W_1 := B_{r/4}(x_1), \phi_1), \dots, (W_t := B_{r/4}(x_t), \phi_t)\}$$

satisfying the following assumptions

- $x_i \in \bar{\Omega}$  for every  $i = 1, \dots, t$ ;
- $d(x_i, x_j) \geq \frac{r}{8}$  for every  $i \neq j$ ;
- $\mathcal{W}$  is maximal (by inclusion).

For a reference see [54, Lemma 1.1]. Moreover, observe that by construction

$$\bigcup_{i \leq t} W_i \subset \Omega_r.$$

Since every chart of  $\mathcal{W}$  is an harmonic chart, then

$$|\Omega_r| \geq \left| \bigcup_{1 \leq i \leq t} B_{r/8}(x_i) \right| = \sum_{i \leq t} |B_{r/8}(x_i)| \geq t 2^{-n/2} |\mathbb{B}_{r/8}|$$

implying that

$$t \leq \frac{|\Omega_r| 2^{n/2}}{|\mathbb{B}_{r/8}|} \quad (1.2.5)$$

where  $\mathbb{B}_s$  denotes the Euclidean ball of radius  $s$ . Now let  $\mathcal{U}$  and  $\mathcal{V}$  the dilated covers obtained from  $\mathcal{W}$

$$\begin{aligned} \mathcal{U} &:= \{(U_1 := B_r(x_1), \phi_1), \dots, (U_t := B_r(x_t), \phi_t)\} \\ \mathcal{V} &:= \{(V_1 := B_{r/2}(x_1), \phi_1), \dots, (V_t := B_{r/2}(x_t), \phi_t)\}. \end{aligned}$$

Observe that

$$W_i \cap W_j \neq \emptyset \quad \Rightarrow \quad \exists B_{r/4}(x_{ij}) \subseteq V_i \cap V_j$$

which implies, by (i) in Definition 1.2.1,

$$\begin{aligned} \frac{|V_j|}{|V_i \cap V_j|} &= \frac{|B_{r/2}(x_j)|}{|V_i \cap V_j|} \leq \frac{|B_{r/2}(x_j)|}{|B_{r/4}(x_{ij})|} \\ &\stackrel{(i)}{\leq} \frac{2^{n/2} |\mathbb{B}_{r/2}|}{2^{-n/2} |\mathbb{B}_{r/4}|} = \frac{2^n |\mathbb{B}_{r/2}|}{|\mathbb{B}_{r/4}|} \leq 2^n C_{\mathbb{R}^n} \end{aligned} \quad (1.2.6)$$

whenever  $W_i \cap W_j \neq \emptyset$ , where  $C_{\mathbb{R}^n} = 2^n$  is the Euclidean doubling constant. It follows that if  $W_i \cap W_j \neq \emptyset$

$$\int_{V_i \cap V_j} v^p \leq C_D \int_{V_j} v^p \quad (1.2.7)$$

where  $C_D := 4^n$ .

In any local chart  $U_i$  we can apply Theorem 1.2.3, obtaining

$$\begin{aligned} \int_{V_i} v^p \, dv &\leq 2^n \int_{\mathbb{B}_{r/2}} (v \circ \phi_i)^p \, dx \\ &\leq 2^n C_1^p \left[ \inf_{\mathbb{B}_{r/2}} v \circ \phi_i^{-1} + \frac{r}{2} \|F \circ \phi_i^{-1}\|_{L^n(\mathbb{B}_r)} \right]^p \\ &\leq 2^n C_1^p \left[ \inf_{V_i} v + \frac{r}{2} \sqrt{2} \|F\|_{L^n(U_i)} \right]^p \end{aligned} \quad (1.2.8)$$

that implies

$$\begin{aligned} \left( \int_{V_i} v^p \, dv \right)^{1/p} &\leq \overbrace{2^{n/p} C_1}^{=: \tilde{C}_1} \left[ \inf_{V_i} v + \frac{r}{\sqrt{2}} \|F\|_{L^n(U_i)} \right] \\ &\leq \tilde{C}_1 \left[ \inf_{V_i} v + r \|F\|_{L^n(U_i)} \right] \quad \forall i = 1, \dots, t. \end{aligned} \quad (1.2.9)$$

Summing up over  $i = 1, \dots, t$ , on the left side of (1.2.8) we have

$$\sum_{i \leq t} \int_{V_i} v^p \geq \frac{1}{|\hat{\Omega}|} \int_{\hat{\Omega}} v^p = \int_{\hat{\Omega}} v^p \quad (1.2.10)$$

where

$$\hat{\Omega} := \bigcup_{1 \leq i \leq t} V_i \subseteq \Omega_r.$$

Now let  $j \in \{1, \dots, t\}$  be so that

$$\left( \inf_{V_j} v + r \|F\|_{L^n(U_j)} \right) = \max_{i \leq t} \left( \inf_{V_i} v + r \|F\|_{L^n(U_i)} \right).$$

and let  $\mathcal{S} := \{W_{i_1}, \dots, W_{i_m}\} \subseteq \mathcal{W}$  be a sequence of coordinate neighbourhoods joining  $W_j =: W_{i_1}$  and  $z_0 \in W_{i_m}$  and such that

$$\begin{aligned} W_{i_q} &\neq W_{i_s} \quad \forall q \neq s, \\ W_{i_q} \cap W_{i_{q+1}} &\neq \emptyset \quad \forall q = 1, \dots, m-1. \end{aligned}$$

We get

$$\begin{aligned} \inf_{V_j} v &= \inf_{V_{i_1}} v \leq \inf_{V_{i_1} \cap V_{i_2}} v \\ &\leq \left( \int_{V_{i_1} \cap V_{i_2}} v^p \right)^{1/p} \\ &\stackrel{\text{by (1.2.7)}}{\leq} C_D \left( \int_{V_{i_2}} v^p \right)^{1/p} \\ &\stackrel{\text{by (1.2.9)}}{\leq} C_D \tilde{C}_1 \left( \inf_{V_{i_2}} v + r \|F\|_{L^n(U_{i_2})} \right) \\ &\leq C_D \tilde{C}_1 \left( \inf_{V_{i_2}} v + r \|F\|_{L^n(\tilde{\Omega})} \right) \end{aligned}$$

where

$$\tilde{\Omega} = \bigcup_{1 \leq i \leq t} U_i.$$

Iterating

$$\begin{aligned}
\inf_{V_j} v &\leq (C_D \tilde{C}_1)^m \left( \inf_{V_{i_m}} v + m r \|F\|_{L^n(\tilde{\Omega})} \right) \\
&= (C_D \tilde{C}_1)^m \left( m r \|F\|_{L^n(\tilde{\Omega})} \right) \\
&\leq (C_D \tilde{C}_1)^t \left( t \operatorname{diam}(\Omega) \|F\|_{L^n(\tilde{\Omega})} \right) \\
&= C_2 \operatorname{diam}(\Omega) \|F\|_{L^n(\tilde{\Omega})}
\end{aligned}$$

where, using (1.2.5),  $C_2 := t(C_D \tilde{C}_1)^t$  can be bounded from above by

$$C_2 \leq \frac{|\Omega_r| 2^{n/2}}{|\mathbb{B}_{r/8}|} (C_D \tilde{C}_1)^{\frac{|\Omega_r| 2^{n/2}}{|\mathbb{B}_{r/8}|}}.$$

Observe that, without loss of generality,  $C_D \tilde{C}_1 \geq 1$ . In this way we obtain

$$\begin{aligned}
\sum_{i \leq t} \tilde{C}_1^p \left( \inf_{V_i} v + r \|F\|_{L^n(U_i)} \right)^p &\leq t \tilde{C}_1^p \left( \inf_{V_j} v + \operatorname{diam}(\Omega) \|F\|_{L^n(\tilde{\Omega})} \right)^p \\
&\leq \tilde{C}_2^p \left( \operatorname{diam}(\Omega) \|F\|_{L^n(\tilde{\Omega})} \right)^p
\end{aligned} \tag{1.2.11}$$

where  $\tilde{C}_2 := t^{1/p} \tilde{C}_1 (C_2 + 1)$ . Using (1.2.9), (1.2.10) and (1.2.11), it follows

$$\int_{\hat{\Omega}} v^p \leq \tilde{C}_2^p \left( \operatorname{diam}(\Omega) \|F\|_{L^n(\tilde{\Omega})} \right)^p$$

i.e.

$$\left( \int_{\hat{\Omega}} v^p \right)^{1/p} \leq \tilde{C}_2 \operatorname{diam}(\Omega) \|F\|_{L^n(\tilde{\Omega})}. \tag{1.2.12}$$

Recalling that  $v \equiv S$  in  $\hat{\Omega} \setminus \Omega$ , we get

$$\left( \int_{\hat{\Omega}} v^p \right)^{1/p} \geq \left( \frac{1}{|\hat{\Omega}|} \int_{\hat{\Omega} \setminus \Omega} v^p \right)^{1/p} \geq \left( \frac{|\hat{\Omega} \setminus \Omega|}{|\hat{\Omega}|} \right)^{1/p} S =: \theta^{1/p} S$$

and, since  $|F| \leq |f| \chi_{\Omega}$ , by (1.2.12)

$$\left( \int_{\hat{\Omega}} v^p \right)^{1/p} \leq \tilde{C}_2 \operatorname{diam}(\Omega) \|F\|_{L^n(\tilde{\Omega})} \leq \tilde{C}_2 \operatorname{diam}(\Omega) \|f\|_{L^n(\Omega)}.$$

Whence

$$\sup_{\Omega} w = S \leq C \operatorname{diam}(\Omega) \|f\|_{L^n(\Omega)} \tag{1.2.13}$$

where  $C = \frac{\tilde{C}_2}{\theta^{1/p}}$ . In particular, previous inequality implies

$$\sup_{\Omega} w \leq C \operatorname{diam}(\Omega) |\Omega|^{1/n} \|f\|_{L^\infty(\Omega)}.$$



For the general case, i.e. removing the smoothness assumption on  $u$  up to the boundary, we can proceed by an exhaustion of  $\Omega$  by smooth, relatively compact subdomains, as done in [25, Theorem 2.3]. Indeed, let  $\{U_\epsilon\}_{\epsilon>0}$  be a family of relatively compact subdomain of  $\Omega$  with smooth boundary so that  $u \leq \epsilon$  in  $\Omega \setminus U_\epsilon$  (recall that  $\limsup_{x \rightarrow \partial\Omega} u(x) \leq 0$ ) and satisfying  $\bigcup_\epsilon U_\epsilon = \Omega$  and define  $u_\epsilon = u - \epsilon \in C^2(\overline{U_\epsilon})$ . If we consider a sequence  $\{u_k\}_k \subset C^\infty(\overline{U_\epsilon})$  approximating uniformly  $u$  and its derivatives up to order 2, then, defining  $u_{k,\epsilon} := u_k - \epsilon$  and  $F_{k,\epsilon} := \left( \operatorname{div}(A \cdot \nabla u_{k,\epsilon}) + g(B, \nabla u_{k,\epsilon}) \right)^-$ , by (1.2.13) in previous step we get

$$\sup_{U_\epsilon} u_{k,\epsilon} \leq C \operatorname{diam}(\Omega) \|F_{k,\epsilon}\|_{L^n(U_\epsilon)}.$$

Thanks to the properties of the sequences defined, we get

$$\sup_{U_\epsilon} u_{k,\epsilon} \xrightarrow{k} \sup_{U_\epsilon} u_\epsilon$$

and

$$F_{k,\epsilon} \xrightarrow{k} F \quad \text{in } L^n(U_\epsilon)$$

that, together with previous inequality, imply

$$\sup_{U_\epsilon} u_\epsilon \leq C \operatorname{diam}(\Omega) \|F\|_{L^n(U_\epsilon)},$$

i.e.

$$\sup_{U_\epsilon} u \leq C \operatorname{diam}(\Omega) \|f\|_{L^n(U_\epsilon)} + \epsilon.$$

Letting  $\epsilon \rightarrow 0$ , thanks to the fact that  $\limsup_{x \rightarrow \partial\Omega} u \leq 0$  and  $U_\epsilon \rightarrow \Omega$ , we finally get

$$\sup_{\Omega} u \leq C \operatorname{diam}(\Omega) \|f\|_{L^n(\Omega)}.$$

□

**Remark 1.2.8.** Observe that the constant  $C$  in previous theorem depends on  $n, a, b, c_0, C_0$  and on the family of harmonic neighbourhoods  $\mathcal{W}$  that  $\Omega$  intersects. In particular, if  $\Omega$  and  $\Omega'$  are covered by the same family of harmonic neighbourhoods  $\mathcal{W}$ ,  $|\Omega| > |\Omega'|$  and  $C$  and  $C'$  are the constants given by Theorem 1.2.2 on  $\Omega$  and  $\Omega'$  respectively, then

$$C > C'.$$

As a consequence, the constant  $C$  is monotone (increasing) with respect to the inclusion and so we can use the same  $C = C(\Omega)$  for every subdomain  $\Omega' \subseteq \Omega$ .

**Remark 1.2.9.** The explicit expression of the constant  $C$  in (1.2.4) is the following

$$C = \frac{t^{1/p} 2^{n/p} \left[ t \left( 2^{n(p+1)/p} C_{\mathbb{R}^n} C_1 \right)^t + 1 \right]}{\theta^{1/p}}$$

where, denoting  $r := r_h(\overline{\Omega})$ ,

- $p = p(n, r, a, b, c_0, C_0)$  and  $C_1 = C_1(n, r, a, b, c_0, C_0)$  are the constants given in Theorem 1.2.3;
- $C_{\mathbb{R}^n}$  is the Euclidean doubling constant;
- $\theta = 1 - \frac{|\Omega|}{|\widehat{\Omega}|}$ ;
- $t \leq \frac{|\Omega_r| 2^{n/2}}{|\mathbb{B}_{r/8}|}$ .

Observe that in the Euclidean case we have  $r_h = +\infty$ , implying that if  $\Omega \subset \mathbb{R}^n$  is a fixed bounded domain, then we can choose a radius  $R = (8 \operatorname{diam}(\Omega))$  in order to get  $\Omega \subset \mathbb{B}_{R/8}$ . By Remark 1.2.8, we can use the ABP constant of the domain  $\mathbb{B}_{R/8}$  also for the domain  $\Omega$ . In particular, thanks to the Euclidean (global) doubling property, the constants  $t$  and  $\theta$  of the domain  $B_{R/8}$  do not depend neither on  $\mathbb{B}_{R/8}$  nor  $\Omega$ , while the constants  $p$  and  $C_1$  depend on  $n$ ,  $R$  (and hence on  $\operatorname{diam}(\Omega)$ ),  $b, c_0$  and  $C_0$ . This means that in case  $M = \mathbb{R}^n$  the constant in Theorem 1.2.2 depends on the domain  $\Omega$  only through its diameter. Moreover, by Remark 1.2.4, this last dependence on the diameter of  $\Omega$  is avoided in case  $b = 0$  (for instance for the Euclidean Laplacian).

### 1.2.2 Generalized principal eigenfunction in general bounded domains

As already claimed, the aim of this section is to prove a maximum principle for smooth unbounded domains in a general Riemannian manifold. While in the bounded case the validity of the maximum principle is strictly related to the positivity of the first Dirichlet eigenvalue, in unbounded domains the existence of classical principal eigenvalues is not even guaranteed. In this direction, following what S. Nordman has done in [77], we consider a generalization of the notion of principal eigenvalue (and related eigenfunction) in order to extend this relation to unbounded smooth domains.

**Definition 1.2.10** (Generalized principal Dirichlet eigenvalue). *The generalized principal Dirichlet eigenvalue of the operator  $\mathcal{L}$  acting on a (possibly nonsmooth) domain  $\Omega \subset M$  is defined as*

$$\lambda_1^{-\mathcal{L}}(\Omega) := \sup\{\lambda \in \mathbb{R} : \mathcal{L} + \lambda \text{ admits a positive supersolution}\}$$

where  $u$  is said to be a supersolution for the operator  $\mathcal{L} + \lambda$  if  $u \in C^2(\overline{\Omega})$  and it satisfies

$$\begin{cases} (\mathcal{L} + \lambda)u \leq 0 & \text{in } \Omega \\ u \geq 0 & \text{on } \partial\Omega. \end{cases}$$

Clearly, the previous definition makes sense both in bounded and unbounded domains and in the former case it coincides with the classical notion of principal eigenvalue. Moreover, if  $A^{-1} \cdot B = \nabla\eta$  for a smooth function  $\eta$  (for instance, if  $B \equiv 0$ ), then  $\mathcal{L}$  is symmetric on  $L^2(\Omega, dv_\eta)$ , where  $dv_\eta = e^\eta dv$ , and we have a variational characterization of  $\lambda_1$  through the Rayleigh identity

$$\lambda_1^{-\mathcal{L}}(\Omega) = \inf_{\substack{\psi \in H_0^1(\Omega, dv_\eta) \\ \|\psi\|_{L^2(\Omega, dv_\eta)} = 1}} \left( \int_{\Omega} g(A \cdot \nabla\psi, \nabla\psi) dv_\eta - \int_{\Omega} c\psi^2 dv_\eta \right).$$

The next step consists in proving the existence of a couple of generalized eigenelements in bounded (and possibly nonsmooth) domains, following what was done by Berestycki, Nirenberg and Varadhan in [11]. The first result we need is a boundary Harnack inequality, obtained adapting [9, Theorem 1.4] to the Riemannian setting.

**Theorem 1.2.11** (Krylov-Safonov Boundary Harnack inequality). *Let  $(M, g)$  be a complete Riemannian manifold and  $\Omega \subset M$  a bounded domain with possibly nonsmooth boundary. Let  $b > 0$  so that  $|B|, |c| \leq b$  in an open neighbourhood of  $\Omega$ . Fix  $x_0 \in \Omega$  and consider  $G \subset \Omega \cup \Sigma$  compact, where  $\Sigma$  is a smooth open subset of  $\partial\Omega$ . Then, there exists a positive constant  $C$ , depending on  $x_0, \Omega, \Sigma, G, a, b, c_0$  and  $C_0$ , so that for every nonnegative function  $u \in W_{loc}^{2,p}(\Omega \cup \Sigma)$ ,  $p > n$ , satisfying*

$$\begin{cases} \mathcal{L}u = 0 & \text{a.e. in } \Omega \\ u > 0 & \text{in } \Omega \\ u = 0 & \text{on } \Sigma \end{cases}$$

we have

$$u(x) \leq Cu(x_0) \quad \forall x \in G.$$

*Proof.* Let  $\mathcal{U} := \{U_1, \dots, U_m\}$  be a family of local charts of  $M$  intersecting and covering  $\partial\Omega$  and with the property that  $\partial G \cap U_i$  is connected for every  $i$ . Fix  $\epsilon > 0$  small enough so that  $d^M(x_0, \partial\Omega) > 2\epsilon$ ,

$$\emptyset \neq \{x \in \Omega : d(x, \partial\Omega) \in (\epsilon, 2\epsilon)\} \subseteq \bigcup_{1 \leq i \leq m} U_i$$

and

$$\{x \in \Omega : d(x, \partial\Omega) > 2\epsilon\} \neq \emptyset.$$

Let  $\Omega_\epsilon$  a smooth subdomain of  $\Omega$  satisfying

$$\{x \in \Omega : d(x, \partial\Omega) > 2\epsilon\} \subseteq \Omega_\epsilon \subseteq \{x \in \Omega : d(x, \partial\Omega) > \epsilon\}.$$

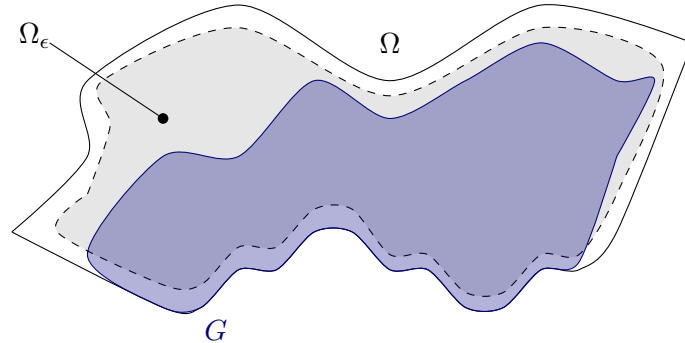

Clearly,  $\partial\Omega_\epsilon \subset \bigcup_{1 \leq i \leq m} U_i$ . Now complete  $\mathcal{U}$  to a cover of  $\Omega$  by coordinate neighbourhoods of  $M$

$$\mathcal{V} = \mathcal{U} \cup \mathcal{U}' = \mathcal{U} \cup \{U_{m+1}, \dots, U_h\}$$

so that

$$\bar{\Omega}_\epsilon \subset \bigcup_{m+1 \leq i \leq h} U_i \quad \text{and} \quad \partial\Omega \cap \left( \bigcup_{m+1 \leq i \leq h} U_i \right) = \emptyset.$$

Up to considering a larger family  $\mathcal{U}'$ , we can suppose that for every  $i = m+1, \dots, h$  there exists  $W_i \Subset U_i$  open subset such that

$$\bar{\Omega}_\epsilon \subset \bigcup_{m+1 \leq i \leq h} W_i, \quad \partial\Omega \cap \left( \bigcup_{m+1 \leq i \leq h} W_i \right) = \emptyset$$

and

$$W_i \cap W_j \neq \emptyset \quad \Leftrightarrow \quad U_i \cap U_j \neq \emptyset.$$

Lastly, up to considering a larger family  $\mathcal{U}$  and a smaller  $\epsilon$ , we can suppose that for every  $i \in \{1, \dots, m\}$  there exists a compact subset  $E_i \subset (U_i \cap \bar{\Omega})$  so that

$$\bar{\Omega} \setminus \Omega_\epsilon \subset \bigcup_{1 \leq i \leq m} E_i$$

and every  $E_i$  intersects at least one  $W_j$ .

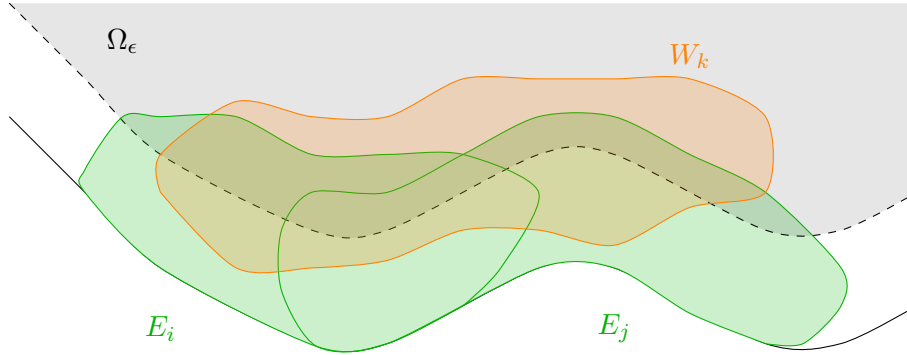

For every  $i = m+1, \dots, h$  we can apply the Euclidean version of Krylov-Safonov Harnack inequality, [41, Corollary 8.21], to the couple  $W_i \Subset U_i$ . Let  $C_i = C_i(n, U_i, b, c_0, C_0, W_i) > 0$  be the corresponding constant and define

$$K := \max_{m+1 \leq i \leq h} C_i \geq 1.$$

If  $x \in G$ , we have two possible cases:

1.  $x \in G \cap \Omega_\epsilon$ : we can consider a sequence of distinct neighbourhoods  $U_{i_1}, \dots, U_{i_t} \in \mathcal{U}'$  so that

$$x \in W_{i_1}, \quad x_0 \in W_{i_t} \quad \text{and} \quad W_{i_j} \cap W_{i_{j+1}} \neq \emptyset \quad \forall j = 1, \dots, t-1$$

and by (Euclidean) Krylov-Safonov Harnack inequality, we get

$$\begin{aligned} u(x) &\leq \sup_{W_{i_1}} u \leq K \inf_{W_{i_1}} u \leq K \inf_{W_{i_1} \cap W_{i_2}} u \leq K \sup_{W_{i_2}} u \\ &\leq K^2 \inf_{W_{i_2}} u \leq \dots \leq K^t \inf_{W_{i_t}} u \leq K^t u(x_0). \end{aligned}$$

Since the sequence of neighbourhoods can be chosen with at most  $h - m$  different elements, it follows that

$$u(x) \leq \widetilde{K} u(x_0)$$

where  $\widetilde{K} := K^{h-m}$  does not depend on the choice of  $x \in G \cap \Omega_\epsilon$ .

2.  $x \in G \setminus \Omega_\epsilon$ : without loss of generality, we can suppose  $x \in U_1$ . By Theorem 1.4 in [9] applied to  $U_1$  and  $E_1$ , we get

$$u(x) \leq B_1 u(z(x))$$

where  $B_1 = B_1(n, a, b, c_0, C_0, U_1, E_1) > 1$  and  $z(x) \in U_1 \cap W_j$  for some  $j \geq m+1$ , up to enlarge slightly  $W_j$  and  $E_1$ . Retracing what done in previous point, we obtain that

$$u(x) \leq B_1 u(z(x)) \leq B_1 \sup_{W_j} u \leq B_1 \widetilde{K} u(x_0).$$

Choosing  $B := \max_{1 \leq i \leq m} B_i$  and defining  $C := B\widetilde{K} \geq \widetilde{K}$ , we get

$$u(x) \leq C u(x_0)$$

for every  $x \in G$ , obtaining the claim.  $\square$

**Remark 1.2.12.** Observe that  $C$  actually depends only on the neighbourhoods that  $G$  intersects and not really on  $G$ , i.e.  $C$  is “stable” under small perturbations.

As in [11], the next stage consists in the construction of a function  $u_0$  which vanishes at those points of  $\partial\Omega$  that admit a *barrier*. It is needed to show that the generalized principal eigenfunction vanishes at smooth portions of  $\partial\Omega$ .

**Definition 1.2.13** (Strong barrier). *We say that  $y \in \partial\Omega$  admits a strong barrier if there exists  $r > 0$  and  $h \in W_{loc}^{2,n}(\Omega \cap B_r(y))$  which can be extended continuously to  $y$  by setting  $h(y) = 0$  and so that*

$$\mathcal{M}h \leq -1.$$

**Remark 1.2.14.** As proved by Miller in [73], the strong barrier condition at  $y \in \partial\Omega$  is implied by the exterior cone condition in any local chart, i.e. by the fact that in every local chart around  $y$  there exists an exterior truncated cone  $C_y$  with vertex at  $y$  and lying outside  $\bar{\Omega}$ . In particular, on every smooth sector  $\Sigma$  of  $\partial\Omega$  every point  $y \in \Sigma$  satisfies the (local) exterior cone condition, and thus the strong barrier condition.

**Theorem 1.2.15.** *Let  $(M, g)$  be a complete Riemannian manifold. Given a (possibly nonsmooth) bounded domain  $\Omega \subset M$ , there exists  $u_0$  positive solution to  $\mathcal{M}u_0 = -g_0 \in \mathbb{R}_{<0}$  in  $\Omega$  that can be extended as a continuous function at every point  $y \in \partial\Omega$  admitting a strong barrier by setting  $u_0(y) = 0$ .*

*Proof.* Consider  $\Lambda \subset M$  a bounded, open and smooth domain containing  $\bar{\Omega}$  properly and let  $\mathcal{G}$  be the positive Dirichlet Green function on  $\bar{\Lambda}$  associated to the differential operator  $\mathcal{M} - 1$ . Fixed  $x_0 \in \Lambda \setminus \bar{\Omega}$ , let  $G(\cdot) := \mathcal{G}(x_0, \cdot)$  so to have

$$\begin{cases} \mathcal{M}G = G & \text{in } \Omega \\ G > 0 & \text{in } \bar{\Omega} \end{cases}$$

and define

$$g_0 = \min_{\bar{\Omega}} G \quad \text{and} \quad G_0 = \max_{\bar{\Omega}} G.$$

Consider an exhaustion  $\{H_j\}_j$  of  $\Omega$  by smooth nested subdomains satisfying  $\bar{H}_j \subset H_{j+1}$  and let  $u_j$  be the solutions to

$$\begin{cases} \mathcal{M}u_j = -g_0 & \text{in } H_j \\ u_j = 0 & \text{on } \partial H_j. \end{cases}$$

In particular,  $u_j \in W^{2,p}(H_j)$  for every  $p > n$  and, by the standard maximum principle,  $\{u_j\}_j$  is an increasing sequence of positive functions. Moreover

$$\mathcal{M}(u_j + G) = -g_0 + G \geq 0$$

so, again by maximum principle, it follows that

$$u_j + G \leq \max_{\partial H_j} G \leq G_0,$$

i.e.  $u_j \leq G_0 - G \leq G_0$  for every  $j$ . Hence there exists a function  $u_0$  so that

$$\begin{aligned} u_j &\rightharpoonup u_0 && \text{in } W^{2,p}(E) \\ u_j &\rightarrow u_0 && \text{in } C^1(E) \end{aligned}$$

for every  $p > n$  and every  $E \subset \Omega$  compact. Moreover,  $\mathcal{M}u_0 = -g_0$  and  $0 < u_0 \leq G_0$  by construction.

The next step consists in proving that  $u_0$  can be extended continuously to 0 at every  $y \in \partial\Omega$  admitting a strong barrier. Fix such a  $y \in \partial\Omega$  admitting a strong barrier, i.e. so

that for some  $B_r(y)$  there exists in  $U = B_r(y) \cap \Omega$  a positive function  $h \in W_{loc}^{2,n}(U)$  satisfying  $\mathcal{M}h \leq -1$  which can be extended continuously to  $y$  by imposing  $h(y) = 0$ . Without loss of generality, we can suppose  $r < \text{inj}(y)$ . Let  $h$  be the strong barrier associated to  $y$  and choose  $j$  big enough so that  $V = H_j \cap B_{r/2}(y) \neq \emptyset$ : choosing  $\epsilon > 0$  small so that

$$\epsilon \mathcal{M} \left( d(x, y)^2 \right) \leq \frac{1}{2} \quad \text{in } U$$

the function  $\tilde{h} = h + \epsilon d(x, y)^2$  satisfies

$$\mathcal{M}\tilde{h} \leq -\frac{1}{2} \quad \text{in } U.$$

Moreover, if  $d(x, y) = \frac{r}{2}$  and  $x \in \overline{H}_j$ , then

$$\tilde{h}(x) \geq \epsilon \frac{r^2}{4} =: \delta$$

and, up to decrease  $\epsilon$ , we can suppose  $\delta \leq 1$  and that the function  $w = G_0 \frac{\tilde{h}}{\delta} - u_j$  satisfies

$$\begin{cases} \mathcal{M}w \leq 0 & \text{in } V \\ w \geq 0 & \text{on } \partial V. \end{cases}$$

By the Maximum Principle, it follows  $w \geq 0$  in  $V$ , i.e.

$$u_j(x) \leq G_0 \frac{\tilde{h}(x)}{\delta} \quad \text{in } V.$$

Fixing  $x \in H_j \cap B_{r/2}(y)$  and letting  $j \rightarrow +\infty$ , it follows

$$u_0(x) \leq G_0 \frac{\tilde{h}(x)}{\delta}.$$

Since the previous inequality holds for every  $x \in H_j \cap B_{r/2}(y)$  and for every  $j$  big enough, by the continuity of  $\tilde{h}$  in  $y$  the claim follows.  $\square$

**Remark 1.2.16.** Theorem 1.2.15 has been obtained thanks to an adaptation of the argument presented in [11, Section 3]. Unless small details, the structure of the proof remained unchanged with respect to the one by Berestycki, Nirenberg and Varadhan.

Finally, we can prove the existence of a generalized principal eigenfunction in any bounded Riemannian domain, generalizing [11, Theorem 2.1]

**Theorem 1.2.17.** *Let  $(M, g)$  be a complete Riemannian manifold of dimension  $\dim(M) = n$  and consider a (possibly nonsmooth) bounded domain  $\Omega \subset M$ . Let  $b > 0$  so that  $|B|, |c| \leq b$  in an open neighbourhood of  $\Omega$ . If  $u_0$  is the function obtained in Theorem 1.2.15, then*

1. there exists a principal eigenfunction  $\phi$  of  $\mathcal{L}$

$$\mathcal{L}\phi = -\lambda_1\phi$$

so that  $\phi \in W_{loc}^{2,p}(\Omega)$  for every  $p < +\infty$ ;

2. normalizing  $\phi$  to have  $\phi(x_0) = 1$  for a fixed  $x_0 \in \Omega$ , there exists a positive constant  $C$ , depending only on  $x_0$ ,  $\Omega$ ,  $a$ ,  $b$ ,  $c_0$  and  $C_0$ , so that  $\phi \leq C$ ;

3. there exists a positive constant  $E > 0$  so that  $\phi \leq Eu_0$ .

**Remark 1.2.18.** The proof proceeds along the lines of [11, Theorem 2.1]. We present it for completeness.

*Proof.* Fix  $x_0 \in \Omega$  and consider a compact subset  $F \subset \Omega$  so that  $x_0 \in \text{int } F$  and  $|\Omega \setminus F| = \delta$ , where  $\delta > 0$  is a constant (small enough) to be chosen. Let  $\{\Omega_j\}_j$  be a sequence of relatively compact smooth subdomains of  $\Omega$  with  $F \subset \Omega_1$  and satisfying

$$\bar{\Omega}_i \subset \Omega_{i+1} \quad \forall i \quad \text{and} \quad \bigcup_i \Omega_i = \Omega.$$

By the smoothness of  $\Omega_j$ , for every  $j$  there exists a couple of principal eigenelements  $(\mu_j, \phi_j)$  for  $\mathcal{L}$  so that

$$\begin{cases} \mathcal{L}\phi_j = -\mu_j\phi_j & \text{in } \Omega_j \\ \phi_j > 0 & \text{in } \Omega_j \\ \phi_j = 0 & \text{on } \partial\Omega_j \end{cases}$$

rescaled so that  $\phi_j(x_0) = 1$  and with  $\phi_j \in W^{1,p}(\Omega_j)$  for every  $p < +\infty$ . Moreover, since  $\phi_k > 0$  in  $\bar{\Omega}_j$  for  $k > j$ , by the standard maximum principle it follows that  $\mu_j > \mu_{j+1} > \lambda_1 := \lambda_1^{-\mathcal{L}}(\Omega)$  for every  $j$ . In particular, by monotonicity  $\{\mu_j\}_j$  converges to a certain  $\mu \geq \lambda_1$ .

By the standard Harnack inequality applied in  $\Omega_1$  it follows that there exists a positive constant  $C = C(n, a, b, c_0, C_0, x_0, \Omega_1, F)$  so that

$$\max_F \phi_j \leq C \phi_j(x_0) = C \tag{1.2.14}$$

for every  $j \geq 1$ .

Now consider  $U_j := \Omega_j \setminus F$  and  $v = \phi_j - C$ : we have

$$\mathcal{M}v = -c\phi_j - \mu_j\phi_j \geq -b\phi_j - \mu_j\phi_j$$

and

$$\limsup_{x \rightarrow \partial U_j} v \leq 0.$$



Let  $\Lambda$  be a smooth, bounded domain containing  $\bar{\Omega}$  and let  $C_\Lambda$  be the constant given by Theorem 1.2.2 on  $\Lambda$ . Without loss of generality, we can suppose  $|B|, |c| \leq b$  in  $\Lambda$ . Observing that  $\bar{U}_j \subset \Lambda$  for every  $j$ , by Theorem 1.2.2 and Remark 1.2.8 it follows that

$$\begin{aligned} \max_{\bar{U}_j} \phi_j - C &= \max_{\bar{U}_j} v \\ &\leq C_\Lambda \operatorname{diam}(\Lambda) \|(b + \mu_j)\phi_j\|_{L^n(U_j)} \\ &\leq C_\Lambda \operatorname{diam}(\Lambda) (b + \mu_j) \max_{\bar{U}_j} \phi_j \delta^{\frac{1}{n}}. \end{aligned} \tag{1.2.15}$$

Let  $B_r$  be a ball completely contained in  $F$ : by [78, Lemma 6.3] there exists a positive constant  $K$ , depending only on  $\dim(M)$  and on the coefficients of  $\mathcal{L}$ , so that

$$\mu_j \leq \frac{K}{r^2}.$$

Using the previous inequality in (1.2.15), we get

$$\max_{\bar{U}_j} \phi_j - C \leq C_\Lambda \operatorname{diam}(\Lambda) \left(b + \frac{K}{r^2}\right) \max_{\bar{U}_j} \phi_j \delta^{\frac{1}{n}}$$

and choosing  $\delta$  small enough so that

$$C_\Lambda \operatorname{diam}(\Lambda) \left(b + \frac{K}{r^2}\right) \delta^{\frac{1}{n}} \leq \frac{1}{2}$$

we obtain

$$\max_{\bar{U}_j} \phi_j \leq 2C$$

that, together with (1.2.14), implies

$$\max_{\bar{\Omega}_j} \phi_j \leq 2C =: C.$$

By interior  $W^{2,p}$  estimates ([41, Theorem 6.2]), it follows that

$$\|\phi_k\|_{W^{2,p}(\Omega_j)} \leq C_j \quad \forall k \geq j + 1$$

implying the existence of a function  $\phi$ , positive in  $\Omega$ , so that

$$\begin{aligned} \phi_j &\rightharpoonup \phi && \text{in } W_{loc}^{2,p}(\Omega) \\ \phi_j &\rightarrow \phi && \text{in } W_{loc}^{2,\infty}(\Omega). \end{aligned}$$

By construction,  $\phi$  solves

$$\mathcal{L}\phi = -\mu\phi \quad \text{in } \Omega$$

with  $\phi(x_0) = 1$  and  $\phi \leq C$ . Moreover, by definition of  $\lambda_1$  and by the fact that  $\mu \geq \lambda_1$ , it follows that  $\mu = \lambda_1$ , obtaining the claims 1 and 2.

Lastly, observing that

$$\begin{cases} \mathcal{M}\phi_j = -(\mu_j + c)\phi_j \geq -(\mu_j + b)\phi_j & \text{in } \Omega_j \\ \phi_j = 0 & \text{on } \partial\Omega_j \end{cases}$$

and recalling that

$$\begin{cases} \mathcal{M}u_0 = -g & \text{in } \Omega \\ u_0 > 0 & \text{in } \Omega \end{cases}$$

we get

$$\begin{cases} \mathcal{M}\left(\phi_j - \frac{C}{g_0}(\mu_j^+ + b)u_0\right) \geq -(\mu_j + b)C + (\mu_j^+ + b)C \geq 0 & \text{in } \Omega_j \\ \phi_j - \frac{C}{g_0}(\mu_j^+ + b)u_0 < 0 & \text{on } \partial\Omega_j \end{cases}$$

and, by standard maximum principle,

$$\phi_j \leq \frac{C}{g_0}(\mu_j^+ + b)u_0 \quad \text{in } \Omega_j.$$

Letting  $j \rightarrow \infty$ , it follows

$$\phi \leq \frac{C}{g_0}(\lambda_1^+ + b)u_0 = Eu_0.$$

□

**Remark 1.2.19.** Using remark 1.2.14, Theorem 1.2.15 and the third point of the previous theorem, we can see that the function  $\phi$  vanishes on every smooth portion of  $\partial\Omega$ . As a consequence, if we consider a smooth domain  $\Omega$  and  $x_0 \in \partial\Omega$ , then for every  $R > 0$  there exists a couple of eigenelements  $(\varphi^R, \lambda_1^{-\mathcal{L}})$  of the following Dirichlet problem

$$\begin{cases} \mathcal{L}\varphi^R = -\lambda_1^R \varphi^R & \text{in } \Omega \cap B_R(x_0) \\ \varphi^R = 0 & \text{on smooth portions of } \partial(\Omega \cap B_R(x_0)). \end{cases}$$

### 1.2.3 Generalized principal eigenfunction in smooth unbounded domains

As a consequence of previous construction, we get the analogue of Theorem 1.4 in [12]. The Euclidean proof can be retraced step by step thanks to Theorem 1.2.11 and Theorem 1.2.17. We propose it for completeness

**Theorem 1.2.20.** *Given an unbounded smooth domain  $\Omega \subset M$ , for any  $R > 0$  consider the truncated eigenvalue problem*

$$\begin{cases} \mathcal{L}\varphi^R = -\lambda_1^R \varphi^R & \text{in } \Omega \cap B_R \\ \varphi^R = 0 & \text{on } \partial(\Omega \cap B_R) \end{cases} .$$

where  $B_R = B_R(x_0)$  for a fixed  $x_0 \in \partial\Omega$ . Then:

1. for almost every  $R > 0$  there exists and is well defined the couple of eigenvalues  $(\lambda_1^R, \varphi^R)$ , with  $\varphi^R$  positive in  $\Omega \cap B_R$ ;
2.  $\lambda_1^R \searrow \lambda_1$  as  $R \rightarrow +\infty$ ;
3.  $\varphi^R$  converges in  $C_{loc}^{2,\alpha}$  to some  $\varphi$  principal eigenfunction of  $\Omega$ .

*Proof.* By the smoothness of  $\Omega$ , for any  $i \in \mathbb{N}$  there exists  $r(i) \geq i$  so that  $\Omega \cap B_i$  is contained in a single connected component  $\Omega_i$  of  $\Omega \cap B_{r(i)}$ . Moreover, we can suppose  $\Omega_i \subset \Omega_{i+1}$  for every  $i$ . By [1], it follows that

$$\lim_{i \rightarrow \infty} \lambda_1^{-\mathcal{L}}(\Omega_i) = \lambda_1^{-\mathcal{L}}(\Omega).$$

Now fix  $x_1 \in \Omega_1$  and let  $\varphi^i$  the generalized principal eigenfunction of  $-\mathcal{L}$  in  $\Omega_i$ , obtained by Theorem 1.2.17, normalized so that  $\varphi^i(x_1) = 1$ . Fixed  $i > j \in \mathbb{N}$ , since  $\varphi^i \in W^{2,p}(\Omega \cap B_j)$  for every  $p < +\infty$  and vanishes on  $\partial\Omega \cap B_j$ , by Theorem 1.2.11 with  $\Omega = \Omega_{j+1}$ ,  $\Sigma = \partial\Omega \cap B_{j+1}$  and  $G = \overline{\Omega \cap B_j}$ , it follows that there exists a positive constant  $C_j$  so that

$$\sup_{\Omega \cap B_j} \varphi^i \leq C_j \varphi^i(x_1) = C_j \quad \forall i > j.$$

By [41, Theorem 9.13] it follows that  $\{\varphi^i\}_{i>j}$  are uniformly bounded in  $W^{2,p}(\Omega \cap B_{j-1/2})$  for every  $p < +\infty$ . Thus, up to a subsequence

$$\varphi^i \xrightarrow{i} \phi_j \quad \text{in } W^{2,p}(\Omega \cap B_{j-1/2}) \quad \forall p < +\infty$$

and, by [41, Theorem 7.26],

$$\varphi^i \xrightarrow{i} \phi_j \quad \text{in } C^1(\overline{\Omega} \cap B_{j-1})$$

to a nonnegative function  $\phi_j$  that solves

$$\begin{cases} \mathcal{L}\phi_j = -\lambda_1^{-\mathcal{L}}(\Omega)\phi_j & \text{a.e. in } \Omega \cap B_{j-1} \\ \phi_j = 0 & \text{on } \partial\Omega \cap B_{j-1}. \end{cases}$$

By construction,  $\phi_j(x_1) = 1$  and so  $\phi_j$  is positive in  $\Omega \cap B_{j-1}$  by the strong maximum principle. Using a diagonal argument, we can extract a subsequence  $\{\varphi^{i_k}\}_{i_k}$  converging to a positive function  $\varphi$  that is a solution to the above problem for all  $j > 1$ .  $\square$

#### 1.2.4 Maximum principle in smooth unbounded domains

Once that the existence of the couple of (generalized) principal eigenvalues in smooth unbounded domains has been proved, we can proceed to show the validity of the maximum principle under the assumption that the generalized principal eigenvalue is positive. We consider an operator  $\mathcal{L}$  of the form (1.2.1) and we assume that there exists a function  $\eta : \Omega \rightarrow \mathbb{R}$ ,  $\eta \in C^1(\Omega)$  so that

$$\nabla\eta = A^{-1} \cdot B.$$

Following the proof made by Nordman in the Euclidean setting in [77], we need two technical lemmas

**Lemma 1.2.21.** *Let  $(M, g)$  be a Riemannian manifold and  $\Omega \subset M$  a (possibly unbounded) smooth domain. If  $v$  satisfies*

$$\begin{cases} \mathcal{L}v \geq 0 & \text{in } \Omega \\ v \leq 0 & \text{on } \partial\Omega \end{cases}$$

and  $(\lambda_1, \varphi)$  are generalized principal eigenelements of  $\mathcal{L}$  on  $\Omega$  with Dirichlet boundary conditions, defining  $\sigma := \frac{v}{\varphi}$  we get

$$\operatorname{div}(\varphi^2 e^\eta A \cdot \nabla \sigma) \geq \lambda_1 e^\eta \sigma \varphi^2 \quad \text{in } \Omega \quad (1.2.16)$$

and

$$\sigma_+ \varphi^2 g(\nu, A \cdot \nabla \sigma) = 0 \quad \text{on } \partial\Omega \quad (1.2.17)$$

where  $\sigma_+ = \max(0, \sigma)$ . Since  $\varphi = 0$  at  $\partial\Omega$ , condition (1.2.17) must be understood as the limit when approaching the boundary with respect to the direction  $A \cdot \nu$ , where  $\nu$  is the outward pointing unit vector field normal to  $\partial\Omega$ .

*Proof.* By the assumptions, it clearly follows

$$\operatorname{div}(e^\eta A \cdot \nabla v) = e^\eta [\operatorname{div}(A \cdot \nabla v) + g(B, \nabla v)]$$

that, together with the fact that  $v$  is a subsolution, implies

$$\operatorname{div}(e^\eta A \cdot \nabla v) + e^\eta cv = e^\eta \mathcal{L}v \geq 0.$$

Moreover, since  $\varphi$  is a principal eigenfunction, we get

$$\operatorname{div}(e^\eta A \cdot \nabla \varphi) + c e^\eta \varphi = -\lambda_1 e^\eta \varphi,$$

that, using previous inequality, implies

$$\begin{aligned} \operatorname{div}(\varphi^2 e^\eta A \cdot \nabla \sigma) &= \operatorname{div}(\varphi e^\eta A \cdot \nabla v) - \operatorname{div}(v e^\eta A \cdot \nabla \varphi) \\ &\geq e^\eta \underbrace{[g(\nabla \varphi, A \cdot \nabla v) - g(\nabla v, A \cdot \nabla \varphi)]}_{=0 \text{ by the symmetry of } A} + v \lambda_1 e^\eta \varphi \\ &= \lambda_1 e^\eta \sigma \varphi^2 \end{aligned}$$

obtaining (1.2.16).

Now let  $x_0 \in \partial\Omega$  and set  $x_\epsilon := \exp_{x_0}(-\epsilon A(x_0) \cdot \nu(x_0))$  for  $\epsilon > 0$  small enough, where  $\nu$  is the outward pointing unit vector field normal to  $\partial\Omega$ . Recalling that  $v \leq 0$  at  $\partial\Omega$ , we have two possible cases:

1.  $\sigma(x_\epsilon) \leq 0$  as  $\epsilon$  becomes small: then,  $\sigma^+(x_\epsilon) = 0$  and thus (1.2.17) trivially holds in the sense of the limit for  $x$  approaching the boundary of  $\Omega$  along the direction  $A(x_0) \cdot \nu(x_0)$ .

2.  $v(x_0) = 0$  and  $v(x_{\epsilon_n}) > 0$  for a sequence  $\epsilon_n \xrightarrow{n} 0$ : in this case  $g(A(x_0) \cdot \nu(x_0), \nabla v(x_0)) \leq 0$  and, by the standard Hopf's lemma,

$$g(A(x_0) \cdot \nu(x_0), \nabla \varphi(x_0)) = g(A(x_0) \cdot \nu(x_0), \nu(x_0)) g(\nu(x_0), \nabla \varphi(x_0)) > 0,$$

obtaining

$$\lim_{\epsilon \rightarrow 0} \sigma(x_\epsilon) = \frac{g(A(x_0) \cdot \nu(x_0), \nabla v(x_0))}{g(A(x_0) \cdot \nu(x_0), \nabla \varphi(x_0))} \leq 0.$$

From the definition of  $\sigma$  and the fact that  $v(x_0) \leq 0$ , it follows that

$$\begin{aligned} & \varphi^2(x_\epsilon) \sigma^+(x_\epsilon) g(\nu(x_0), A(x_0) \cdot \nabla \sigma(x_\epsilon)) \\ &= [g(A(x_0) \cdot \nu(x_0), \nabla v(x_\epsilon)) \\ & \quad - \sigma(x_\epsilon) g(A(x_0) \cdot \nu(x_0), \nabla \varphi(x_\epsilon))] \underbrace{v^+(x_\epsilon)}_{\xrightarrow{\epsilon \rightarrow 0} 0} \xrightarrow{\epsilon \rightarrow 0} 0 \end{aligned}$$

implying the claim. □

Now consider the sequence of cut-off functions  $\{\rho_k\}_k \subset C_c^\infty(M)$  satisfying

$$\begin{cases} 0 \leq \rho_k \leq 1 \\ \|\nabla \rho_k\|_{L^\infty(M)} \xrightarrow{k} 0 \\ \rho_k \nearrow 1. \end{cases} \quad (1.2.18)$$

For a reference, see [86]. Without loss of generality we can suppose

$$\{\rho_k \neq 0\} \cap \partial\Omega \neq \emptyset$$

for every  $k$ .

**Lemma 1.2.22.** *Let  $(M, g)$  be a Riemannian manifold and  $\Omega \subset M$  a (possibly unbounded) smooth domain. Supposing  $\lambda_1 := \lambda_1^{-\mathcal{L}}(\Omega) \geq 0$ , we have*

$$\lambda_1 \int_{\Omega} \rho_k^2 e^\eta (v^+)^2 \, dv \leq \int_{\Omega} g(\nabla \rho_k, A \cdot \nabla \rho_k) e^\eta (v^+)^2 \, dv$$

for every  $k$ , where  $\{\rho_k\}_k \subset C_c^\infty(M)$  is a sequence of cut-off functions satisfying (1.2.18) and so that  $\{\rho_k \neq 0\} \cap \partial\Omega \neq \emptyset$ .

*Proof.* Fix  $k \in \mathbb{N}$  and let  $U_k \subset\subset M$  be an open domain so that

- $\text{supp}(\rho_k) \subset U_k$ ;
- $\Sigma_k := U_k \cap \partial\Omega$  is smooth (possibly not connected).

Let  $\nu$  be the outward pointing unit vector field normal to  $\partial\Omega$  and, for  $\epsilon > 0$  small enough, define

$$S_{k,\epsilon} := \{y \in U_k \cap \Omega : y = \exp_x(-\epsilon A(x) \cdot \nu(x)) \text{ for } x \in \partial\Omega\}.$$

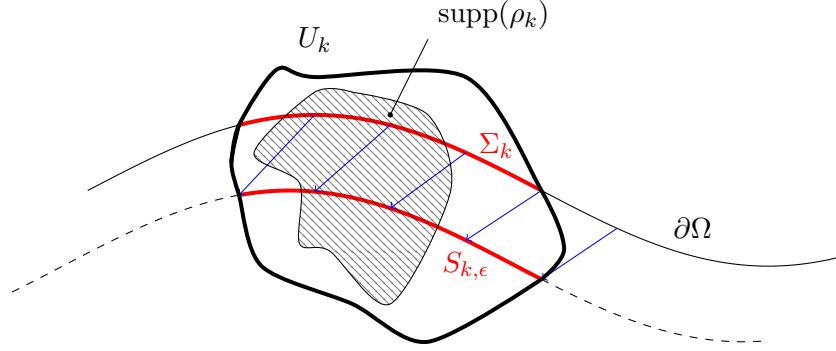

Next step consists in proving that there exists  $\epsilon_k > 0$  so that  $S_{k,\epsilon}$  is a (possibly not connected) smooth hypersurface of  $\Omega$  for every  $0 \leq \epsilon \leq \epsilon_k$ . To this aim, let  $p \in M$  and define  $O_p \subset T_p M$  as the set of vectors  $X_p$  such that the length  $l_{X_p}$  of the geodesic whose initial data is  $(p, X_p)$  is greater than 1. Observe that if  $\alpha \in \mathbb{R}_{>0}$ , then  $l_{\alpha X_p} = \alpha^{-1} l_{X_p}$  and hence

$$X_p \in O_p \quad \Rightarrow \quad tX_p \in O_p \quad \forall t \in (0, 1].$$

Set  $O := \cup_{p \in M} O_p$  and observe that the exponential map is smooth on  $O$  ([80, Lemma 5.2.3]).

Now fix  $p \in \partial\Omega$ . Since  $A(p)$  is nonsingular and linear, the differential of the map  $\exp_p \circ A(p) : O_p \cap N_p \partial\Omega \rightarrow M$  evaluated in  $0_p \in O_p$  is nonsingular and it is given by

$$d_{0_p}(\exp_p \circ A(p)) = \underbrace{d_{0_p} \exp_p}_{=Id} \circ d_{0_p} A(p) = A(p).$$

Retracing the proofs Proposition 5.5.1 and Corollary 5.5.3 in [80], we obtain that there exists an open neighbourhood  $W$  of the zero section in  $N\partial\Omega$  (the normal bundle of  $\partial\Omega$ ) on which  $F := \exp \circ A$  is a diffeomorphism onto its image. In particular, there exists a continuous function  $\epsilon : \partial\Omega \rightarrow \mathbb{R}_{>0}$  so that

$$(p, -t\nu(p)) \in W \quad \forall t \in [0, \epsilon(p)]$$

(see the proof of [80, Corollary 5.5.2]). Now consider a neighbourhood  $V_k \subset\subset M$  of  $U_k$  that intersects  $\partial\Omega$  smoothly and so that for

$$\epsilon_k := \min_{p \in \overline{V_k}} \epsilon(p)$$

we have

$$Z_{k,\epsilon} := \{(p, -\epsilon\nu(p)) : p \in V_k \cap \partial\Omega\} \subset W \quad \forall \epsilon \in [0, \epsilon_k].$$

Moreover, up to enlarge  $V_k$ , we have

$$S_{k,\epsilon} = (\exp \circ A)(Z_{k,\epsilon}) \cap U_k.$$

Since  $V_k \cap \partial\Omega$  (and hence  $Z_{k,\epsilon}$ ) is smooth and  $(\exp \circ A)|_{Z_{k,\epsilon}}$  is a diffeomorphism onto its image, it follows that  $S_{k,\epsilon} = (\exp \circ A)(Z_{k,\epsilon}) \cap U_k$  is a smooth (possibly not connected) hypersurface for every  $\epsilon \in [0, \epsilon_k]$ .

Now define

$$\Omega_{k,\epsilon} := [\Omega \cap U_k] \setminus \bigcup_{0 < t < \epsilon} S_{\epsilon,k}$$

and, up to decrease  $\epsilon_k$ , suppose

$$\Omega_{k,\epsilon} \neq \emptyset \quad \forall \epsilon \in [0, \epsilon_k].$$

By construction

$$\bigcup_{0 < \epsilon < \epsilon_k} \Omega_{\epsilon,k} = \Omega \cap U_k.$$

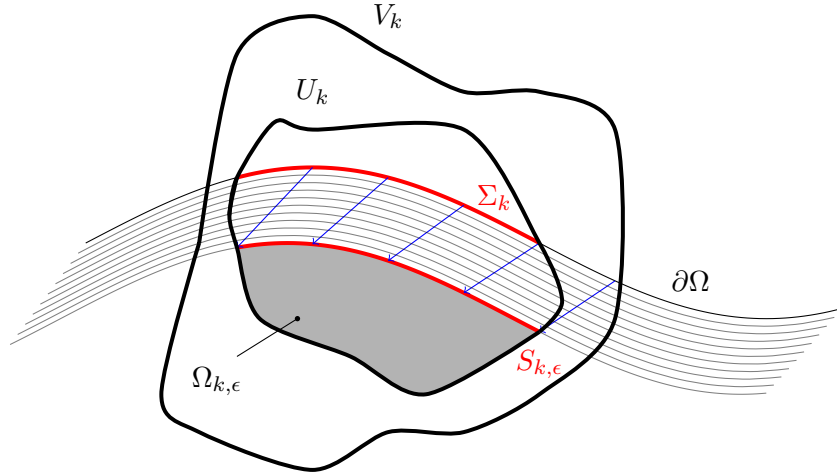

Multiplying (3.6) by  $\sigma^+ \rho_k^2$  and integrating over  $\Omega_{\epsilon,k}$ , by the divergence theorem we get

$$\begin{aligned} \int_{\partial\Omega_{\epsilon,k}} \sigma^+ \rho_k^2 e^\eta \varphi^2 g(\nu, A \cdot \nabla \sigma) - \int_{\Omega_{\epsilon,k}} g(\nabla(\sigma^+ \rho_k^2), A \cdot \nabla \sigma) e^\eta \varphi^2 \\ \geq \lambda_1 \int_{\Omega_{\epsilon,k}} e^\eta \varphi^2 (\sigma^+)^2 \rho_k^2. \end{aligned}$$

Observe that

$$\int_{\partial\Omega_{\epsilon,k}} \sigma^+ \rho_k^2 e^\eta \varphi^2 g(\nu, A \cdot \nabla \sigma) = \int_{S_{\epsilon,k} \cap \text{supp}(\rho_k)} \sigma^+ \rho_k^2 e^\eta \varphi^2 g(\nu, A \cdot \nabla \sigma)$$

since  $\rho_k \equiv 0$  on  $\partial\Omega_{\epsilon,k} \setminus (S_{\epsilon,k} \cap \text{supp}(\rho_k))$ . Moreover,

$$g\left(\nabla\left(\rho_k^2\sigma^+\right), A \cdot \nabla\sigma\right) \geq -g\left(\nabla\rho_k, A \cdot \nabla\rho_k\right)(\sigma^+)^2,$$

obtaining

$$\int_{\partial\Omega_{\epsilon,k}} \sigma^+ \rho_k^2 e^\eta \varphi^2 g(\nu, A \cdot \nabla\sigma) + \int_{\Omega_{\epsilon,k}} g(\nabla\rho_k, A \cdot \nabla\rho_k)(\sigma^+)^2 e^\eta \varphi^2 \quad (1.2.19)$$

$$\geq \lambda_1 \int_{\Omega_{\epsilon,k}} e^\eta \varphi^2 (\sigma^+)^2 \rho_k^2. \quad (1.2.20)$$

The next step is to study the behaviour of previous integrals as  $\epsilon \rightarrow 0$ . Since

$$0 \leq \lambda_1 e^\eta \varphi^2 (\sigma^+)^2 \rho_k^2 \chi_{\Omega_{\epsilon,k}} \leq \lambda_1 e^\eta \varphi^2 (\sigma^+)^2 \rho_k^2$$

and

$$\lambda_1 e^\eta \varphi^2 (\sigma^+)^2 \rho_k^2 \chi_{\Omega_{\epsilon,k}} \rightarrow \lambda_1 e^\eta \varphi^2 (\sigma^+)^2 \rho_k^2 \quad \text{a.e. in } \Omega \text{ as } \epsilon \rightarrow 0,$$

by dominated convergence theorem we get

$$\lambda_1 \int_{\Omega_{\epsilon,k}} e^\eta \varphi^2 (\sigma^+)^2 \rho_k^2 = \lambda_1 \int_{\Omega} e^\eta \varphi^2 (\sigma^+)^2 \rho_k^2 \chi_{\Omega_{\epsilon,k}} \xrightarrow{\epsilon \rightarrow 0} \lambda_1 \int_{\Omega} e^\eta \varphi^2 (\sigma^+)^2 \rho_k^2. \quad (1.2.21)$$

Similarly, using the fact that  $A$  is positive definite, we obtain

$$\int_{\Omega_{\epsilon,k}} g(\nabla\rho_k, A \cdot \nabla\rho_k)(\sigma^+)^2 e^\eta \varphi^2 \xrightarrow{\epsilon \rightarrow 0} \int_{\Omega} g(\nabla\rho_k, A \cdot \nabla\rho_k)(\sigma^+)^2 e^\eta \varphi^2. \quad (1.2.22)$$

Lastly, for  $F := \sigma^+ \rho_k^2 e^\eta \varphi^2 g(\nu, A \cdot \nabla\sigma)$  we have

$$\int_{\partial\Omega_{\epsilon,k}} F(y) = \int_{S_{k,\epsilon}} F(y) = \int_{\partial\Omega} F(\exp_x(-\epsilon A(x) \cdot \nu(x)))$$

and for every  $x \in \partial\Omega$

$$F(\exp_x(-\epsilon A(x) \cdot \nu(x))) \xrightarrow{\epsilon \rightarrow 0} 0$$

by (1.2.17). Using the dominated convergence theorem, we get

$$\int_{\partial\Omega_{\epsilon,k}} \sigma^+ \rho_k^2 e^\eta \varphi^2 g(\nu, A \cdot \nabla\sigma) = \int_{\partial\Omega_{\epsilon,k}} F(y) \xrightarrow{\epsilon \rightarrow 0} 0. \quad (1.2.23)$$

Letting  $\epsilon \rightarrow 0$  in (1.2.19) and using (1.2.21), (1.2.22) and (1.2.23), it follows that

$$\int_{\Omega} g(\nabla\rho_k, A \cdot \nabla\rho_k)(\sigma^+)^2 e^\eta \varphi^2 \geq \lambda_1 \int_{\Omega} e^\eta \varphi^2 (\sigma^+)^2 \rho_k^2,$$

obtaining the claim, since  $\sigma^+ \varphi = v^+$ .  $\square$



We are finally ready to prove the main theorem of this section.

**Theorem 1.2.23** (Unbounded Maximum Principle). *Let  $(M, g)$  be a complete Riemannian manifold and  $\Omega \subset M$  a (possibly unbounded) smooth domain. If  $\lambda_1^{-\mathcal{L}}(\Omega) > 0$ , then every function  $u \in C^2(\bar{\Omega})$  that satisfies*

$$\begin{cases} \mathcal{L}u \geq 0 & \text{in } \Omega \\ u \leq 0 & \text{on } \partial\Omega \\ \sup_{\Omega} u < +\infty \end{cases}$$

is nonpositive.

*Proof.* Let  $u$  be a  $\mathcal{L}$ -subsolution with  $u \leq 0$  at  $\partial\Omega$  and suppose by contradiction that  $u^+ \neq 0$ . By Lemma 1.2.22

$$\lambda_1 \leq \frac{\int_{\Omega} g(\nabla\rho_k, A \cdot \nabla\rho_k) e^{\eta}(u^+)^2}{\int_{\Omega} \rho_k^2 e^{\eta}(u^+)^2}.$$

Now consider the bounded function  $w = e^{\eta/2}u^+$ . We get

$$\frac{g(\nabla\rho_k, A \cdot \nabla\rho_k)w^2}{\int_{\Omega} \rho_k^2 w^2} \leq C_0 \frac{g(\nabla\rho_k, \nabla\rho_k)w^2}{\int_{\Omega} \rho_k^2 w^2} \leq C_0 \frac{\|\nabla\rho_k\|_{L^\infty(M)}^2 w^2}{\int_{\Omega} \rho_k^2 w^2}$$

Since  $\|\nabla\rho_k\|_{L^\infty(M)} \xrightarrow{k} 0$ , up to extract a subsequence we can suppose  $\|\nabla\rho_k\|_{L^\infty(M)} \searrow 0$ , obtaining that the sequence

$$\left\{ \frac{\|\nabla\rho_k\|_{L^\infty(M)}^2 w^2}{\int_{\Omega} \rho_k^2 w^2} \right\}_k$$

is nonincreasing and converges to 0 almost everywhere. By the monotone convergence theorem, we get

$$\begin{aligned} \lambda_1 &\leq \frac{\int_{\Omega} g(\nabla\rho_k, A \cdot \nabla\rho_k) e^{\eta}(v^+)^2}{\int_{\Omega} \rho_k^2 e^{\eta}(v^+)^2} \\ &= \int_{\Omega} \frac{g(\nabla\rho_k, A \cdot \nabla\rho_k) e^{\eta}(v^+)^2}{\int_{\Omega} \rho_k^2 e^{\eta}(v^+)^2} \leq C_0 \int_{\Omega} \frac{\|\nabla\rho_k\|_{L^\infty(M)}^2 w^2}{\int_{\Omega} \rho_k^2 w^2} \xrightarrow{k \rightarrow +\infty} 0 \end{aligned}$$

obtaining a contradiction.  $\square$



---

## Symmetry under stability<sup>1</sup>

---

### 2.1 Basic notation

Throughout this chapter,  $(M, g)$  will always denote a connected Riemannian manifold of dimension  $\dim M = m$ . Moreover, in the special case where  $M = \mathbb{R}^n$  is equipped with its standard flat metric  $g^E$  we set  $\mathbb{B}_R = B_R(0)$ .

A class of Riemannian manifolds of special interest is that of *model manifolds*. Let  $\sigma : [0, R) \rightarrow \mathbb{R}_{\geq 0}$ ,  $0 < R \leq +\infty$ , be a smooth function that is positive in  $(0, R)$  and satisfies

- $\sigma^{(2k)}(0) = 0$  for all  $k \in \mathbb{N}$ ;
- $\sigma'(0) = 1$ .

Then, in polar coordinates around 0, we can define a smooth Riemannian metric on  $(0, R) \times \mathbb{S}^{m-1}$  by setting

$$g = dr \otimes dr + \sigma^2(r)g^{\mathbb{S}^{m-1}},$$

where  $g^{\mathbb{S}^{m-1}}$  is the standard metric on the unit sphere  $\mathbb{S}^{m-1} \subset \mathbb{R}^m$ . The corresponding Riemannian manifold  $\mathbb{M}^m(\sigma) = (\mathbb{B}_R, g)$ , obtained by identifying all the points of the form  $(0, \theta)$  with 0 and extending (smoothly) the metric in 0, will be called an *m-dimensional model manifold with warping function*  $\sigma$ . Clearly,  $\mathbb{M}(\sigma)$  is complete if and only if  $R = +\infty$  and, in any case, the  $r$ -coordinate represents the distance from the *pole*  $o = 0 \in \mathbb{R}^m$ . Thus,  $B_T^{\mathbb{M}(\sigma)}(o) = \{x \in \mathbb{B}_R : r(x) < T\}$ . For more details on the construction of warped product manifolds and model manifolds we suggest [80].

**Example 2.1.1.** The standard spaceforms  $\mathbb{R}^m$ ,  $\mathbb{S}^m \setminus \{pt.\}$  and  $\mathbb{H}^m$  are model manifolds with the choice, respectively,  $\sigma(r) = r$ ,  $\sigma(r) = \sin(r)$ ,  $\sigma(r) = \sinh(r)$ .

Now, let the Riemannian manifold  $(M, g)$  be endowed with the absolutely continuous measure  $dv_\Psi = e^{-\Psi} dv$  where  $dv$  is the Riemannian measure and  $\Psi : M \rightarrow \mathbb{R}$  is a smooth function. Usually, the triple

$$M_\Psi = (M, g, dv_\Psi)$$

---

<sup>1</sup>The content of this chapter is based on [19], a joint work with Prof. Stefano Pigola.

is called a *weighted manifold* or a *manifold with density* or a *smooth metric measure space*.

On the weighted manifold  $M_\Psi$  we have a natural linear elliptic differential operator. It is the *weighted Laplacian*, also called  $\Psi$ -*Laplacian*, which is defined by the formula

$$\Delta_\Psi u = e^\Psi \operatorname{div}(e^{-\Psi} \nabla u) = \Delta u - g(\nabla \Psi, \nabla u).$$

Here,

$$\Delta u = \operatorname{trace} \operatorname{Hess}(u) = \operatorname{div}(\nabla u)$$

stands for the *Laplace-Beltrami* operator of  $(M, g)$ . We stress that we are using the sign convention according to which, in case  $M = \mathbb{R}$ ,  $\Delta = +d^2/dx^2$ . In other terms,  $\Delta$  is a negative definite operator in the spectral sense. Note also that when  $\Psi \equiv \text{const}$  then  $\Delta_\Psi = \Delta$ .

Very often, one sets

$$\operatorname{div}_\Psi X = e^\Psi \operatorname{div}(e^{-\Psi} X)$$

so that the  $\Psi$ -Laplacian takes the suggestive form

$$\Delta_\Psi u = \operatorname{div}_\Psi(\nabla u).$$

Clearly, we have the validity of the  $\Psi$ -divergence theorem on  $M_\Psi$ : given a compact domain  $\Omega$  with smooth boundary and a vector field  $X$ , it holds

$$\int_\Omega \operatorname{div}_\Psi X \, dv_\Psi = \int_{\partial\Omega} g(X, \vec{\nu}) \, da_\Psi$$

where  $\vec{\nu}$  is the exterior unit normal to  $\partial\Omega$ ,  $da_\Psi = e^{-\Psi} da$  and  $da$  is the  $(m-1)$ -dimensional Hausdorff measure of  $\partial\Omega$ . As a simple consequence, the operator  $\Delta_\Psi$  is symmetric on  $L^2(M, dv_\Psi)$ .

The geometry of the weighted manifold  $M_\Psi$  can be controlled by imposing bounds on its family of Bakry-Emery Ricci tensors. In view of our purposes we limit ourselves to introduce the  $\infty$ -Ricci Tensor

$$\operatorname{Ric}_\Psi = \operatorname{Ric} + \operatorname{Hess}(\Psi).$$

**Example 2.1.2.** The Gaussian space

$$\mathbb{G}^m = \left( \mathbb{R}^m, g^{\mathbb{R}^m}, e^{-\frac{|x|^2}{2}} dx \right)$$

is an example of great interest in metric and differential geometry, probability, harmonic and geometric analysis. Its weighted Laplacian  $\Delta_\Psi u = \Delta u - \langle \nabla u, x \rangle$  is the *Ornstein-Uhlenbeck operator*. Obviously the Gaussian space is a weighted model manifold

$$\mathbb{G}^m = \mathbb{M}^m(\sigma)_\Psi$$

with warping function  $\sigma(r) = r$  and symmetric weight  $\Psi(x) = r^2(x)/2$ . A direct computation shows that  $\operatorname{Ric}_\Psi \equiv 1$ .

### 2.1.1 Symmetry under stability

We are going to address the following classical

**Problem 1.** *Let  $\Omega$  be a (possibly non-compact) domain in the weighted Riemannian manifold  $M_\Psi$  and assume that  $\Omega$  has smooth boundary components  $\partial\Omega = (\partial\Omega)_1 \cup \dots \cup (\partial\Omega)_n$ . Let us given a (smooth enough) solution to the semilinear boundary value problem*

$$\begin{cases} \Delta_\Psi u = f(u) & \text{in } \Omega \\ u = \phi_j & \text{on } (\partial\Omega)_j \end{cases} \quad (2.1.1)$$

for some sufficiently regular nonlinearity  $f(t)$ . Assume that the domain, the differential operator and the boundary data display a certain (and same) symmetry. To what extent the solution inherits this symmetry?

We stress that our solutions will be always assumed to be sufficiently regular (say, at least(!)  $C^2$  in the interior and  $C^1$  up to the boundary). The case of weakly regular solutions introduces other nontrivial difficulties and requires further assumptions, as one can see from the very recent [36] by Dupaigne and Farina where they address the (regularity and) symmetry problem in the Euclidean space. We note in passing that, for the Euclidean Poisson equation, sharp conditions on the nonlinearity ensuring that the solutions have a  $C^{1,1}$  interior regularity have been obtained in [62, Theorem 1.1].

In the Euclidean space  $M = \mathbb{R}^n$ , the celebrated theorem by B. Gidas, W.M. Ni and L. Nirenberg, [40], later extended to spherical and hyperbolic spaceforms in [67], states that if  $\Omega = \mathbb{B}$  is the (unit) ball of  $\mathbb{R}^n$ ,  $\Delta_\Psi = \Delta$  is the Euclidean Laplacian and  $\phi \equiv 0$ , then any solution  $u > 0$  of (2.1.1) is rotationally symmetric (and decreasing). The proof makes use of the *moving plane method* and, therefore, requires a lot of homogeneity of the underlying space in order to perform reflections in every direction. It is well known that the positivity of the solution is vital as shown by the (non-symmetric) eigenfunctions relative to higher Dirichlet eigenvalues of the ball. Moreover, the ball itself cannot, in general, be replaced by a non-convex domain, like an annulus, as the seminal example by H. Brezis and L. Nirenberg shows, [24, p. 453].

However, as we are going to see in a quite general geometric setting and as it is proved by N.D. Alikakos and P.W. Bates, [3], in the Euclidean space, both these assumptions become redundant as soon as it is assumed that the solution  $u$  is “stable”.

In fact, in this chapter we shall only focus the case of *stable solutions* of (2.1.1), where the nonlinearity  $f(t)$  is at least  $C^1$ . Stability is a second order condition defined in terms of the first Dirichlet eigenvalue of the linearized (Schrödinger) operator and it is always satisfied if the solution is energy minimizer. More precisely, assume for simplicity that  $\Omega$  is compact. Let  $F(t)$  be a primitive of the  $C^1$  function  $f(t)$  and consider the energy functional

$$\mathcal{E}[v] = \int_{\Omega} \left( \frac{1}{2} |\nabla v|^2 + F(v) \right) dv_\Psi$$

on the space

$$\mathcal{S} = \{v \in C^2(\bar{\Omega}) : v|_{(\partial\Omega)_j} = \phi_j\}.$$

For any  $\varphi \in C_c^\infty(\Omega)$  and  $t \in \mathbb{R}$  it holds  $u_t = u + t\varphi \in \mathcal{S}$ . If  $u$  is a classical solution to the problem, then (integrating by parts)  $u$  is a weak solution to the PDE and, therefore

$$\left. \frac{d}{dt} \right|_{t=0} \mathcal{E}[u_t] = \int_{\Omega} g(\nabla u, \nabla \varphi) \, dv_{\Psi} + \int_{\Omega} f(u)\varphi \, dv_{\Psi} = 0.$$

**Definition 2.1.3** (Stable and strongly stable solutions). *Say that the solution  $u$  is stable if*

$$0 \leq \left. \frac{d^2}{dt^2} \right|_{t=0} \mathcal{E}[u_t] = \int_{\Omega} (|\nabla \varphi|^2 + f'(u)\varphi^2) \, dv_{\Psi}$$

*i.e. the stability operator  $\mathcal{L} = \Delta_{\Psi} - f'(u)$  has nonnegative Dirichlet spectrum:*

$$\lambda_1^{-\mathcal{L}}(\Omega) := \inf_{\varphi \in C_c^\infty(\Omega), \varphi \neq 0} \frac{\int_{\Omega} (|\nabla \varphi|^2 + f'(u)\varphi^2) \, dv_{\Psi}}{\int_{\Omega} \varphi^2 \, dv_{\Psi}} \geq 0.$$

*The solution  $u$  is said to be strongly stable if  $\lambda_1^{-\mathcal{L}}(\Omega) > 0$ .*

We observe that the stability plays a central role also in the setting of noncompact domains. To highlight this fact, we mention the article [8] by H. Berestycki, L. A. Caffarelli and L. Nirenberg, where it is proved that any bounded solution  $u > 0$  to  $\Delta u = f(u)$  in Euclidean half-space  $\mathbb{H}_+^n = \{x_n \geq 0\}$ , with homogeneous Dirichlet boundary conditions depends only on the  $x_n$ -variable, provided that  $f(\sup u) \leq 0$ . As a by-product, they obtain that the solution  $u$  is increasing in  $x_n$ , and hence stable. In subsequent works the viewpoint in some sense is reversed: under suitable conditions on the nonlinearity  $f(u)$  (and possibly on the dimension of the space), it is used in a crucial way that  $x_n$ -monotonic solutions are stable to prove that they in fact depend only on the  $x_n$ -variable. In this direction, we mention the very recent [35] by L. Dupaigne and A. Farina.

As it will be clearer later, if one thinks of the half-space  $\mathbb{H}_+^n$  as a (unbounded) domain foliated by hyperplanes parallel to  $\{x_n = 0\}$ , the monodimensionality of  $u$  proved in [8] and [35] coincides with the notion of *symmetry* we will adopt in the present chapter.

## 2.2 Symmetric domains

As we have already mentioned in the Introduction, the first aspect we need to clarify is what does “symmetric” mean in the setting of Riemannian manifolds. At first glance, “radial symmetry” could appear the most natural notion. However, the recent and very active area of research on the geometry of overdetermined problems of various nature, strongly suggests that the appropriate notion is that of an *isoparametric domain*; see especially the seminal paper [99] by V. Shklover, the papers [97, 98] by A. Savo and the very recent [90] by L. Provenzano and A. Savo.

Isoparametric hypersurfaces in space-forms have a long history that goes back to the first half of the nineteenth century and the modern viewpoint on this theory can be attributed to E. Cartan, [26]. For a gentle introduction on the subject, with plenty of examples and special emphasis on the classification problem in different ambient spaces, we refer the reader to the lecture notes [32] by M. Dominguez-Vazquez and the references therein.

### 2.2.1 Isoparametric domains and tubes

We recall that a *singular Riemannian foliation* of the complete Riemannian manifold  $(M, g)$  is a foliation  $M = \cup_t \Sigma_t$  by smooth, embedded submanifolds such that:

- every geodesic which is perpendicular to one leaf remains perpendicular to every leaf it intersects;
- there exists an integrable distribution  $\mathcal{D}$  pointwise tangent to the leaves of the foliation and which is locally generated (actually globally according to [33]) by a finite family of smooth vector fields.

**Definition 2.2.1** (Isoparametric domain). *An isoparametric domain  $\bar{\Omega} \subseteq M$  is a domain of  $M$  endowed with a singular Riemannian foliation  $\bar{\Omega} = \cup_t \Sigma_t$  whose regular leaves (i.e. those of maximal dimension) are connected parallel complete hypersurfaces (without boundary) with constant mean curvature and with at most two singular (i.e. of codimension greater than one) leaves.*

Here, as usual, we call  $\Sigma_1, \Sigma_2$  parallel if, for every  $x_1 \in \Sigma_1$  and  $x_2 \in \Sigma_2$ ,

$$d^M(x_1, \Sigma_2) = d^M(\Sigma_1, x_2),$$

in other words, if the distance function to  $\Sigma_2$  is constant along  $\Sigma_1$ .

Isoparametric domains arise from *isoparametric functions*, i.e. smooth functions  $f$  whose norm of the gradient and whose Laplacian can be expressed in terms of the function itself. More precisely, there exist a smooth function  $\alpha$  and a continuous function  $\beta$  on the range of  $f$  such that

$$|\nabla f|^2 = \alpha(f) \quad \text{and} \quad \Delta f = \beta(f).$$

These two properties imply, respectively, that level sets foliating the domain are parallel and with constant mean curvature. In particular, an isoparametric function  $f$  for an isoparametric domain  $\bar{\Omega}$  can be provided either by the smooth, signed distance function from a regular leaf or by the smooth absolute distance function from a singular leaf (isoparametric tube). In both cases we call such a leaf the *soul of the domain*.

If  $\bar{\Omega}$  is an isoparametric domain arising from a global isoparametric function  $f : M \rightarrow \mathbb{R}$ , the *focal varieties* of  $f$  are defined as the sets

$$V^- := \left\{ x \in M : f(x) = \min_M f \right\} \quad \text{and} \quad V^+ := \left\{ x \in M : f(x) = \max_M f \right\}.$$

From a classical result by Q. M. Wang, [103], later completed by R. Miyaoka in [74], we have that a singular leaf (if any) of the isoparametric domain described by  $f$  is a focal variety and it is a minimal submanifold.

### 2.2.2 Homogeneous domains

The isoparametric condition provides a very handy model of symmetric domains. However, as we shall see, sometimes the needed notion of symmetry is much stronger.

**Definition 2.2.2** (Homogeneous domain). A homogeneous domain  $\bar{\Omega} \subseteq M$  of a complete Riemannian manifold  $(M, g)$  is an isoparametric domain whose regular leaves are orbits of the action of a closed subgroup  $G \subset \text{Iso}_0(M)$ , the identity component of the group  $\text{Iso}(M)$  of all isometries of  $M$ .

Thus, a domain is homogeneous if the regular leaves of the singular Riemannian foliation are homogeneous hypersurfaces with respect to the same group  $G$  of isometries of the ambient space.

A straightforward consequence of the fact that  $G$  acts transitively on each leaf is that the principal curvatures of the leaves are constant. Moreover, note explicitly that if  $\dim M = m$ , since each regular leaf is homogeneous and can be written as  $\Sigma_t = G/H_p$  for  $H_p \subset G$  isotropy subgroup of  $G$  at  $p \in \Sigma_t$ , then  $\dim G = k \geq m - 1$ .

From the perspective of the present chapter, the most important property enjoyed by homogeneous domains is that the leaves display a lot of (and in fact same) isometric symmetries. These symmetries are encoded in the notion of a Killing vector field that we are going to recall.

A smooth vector field  $X$  on  $M$  is said to be *Killing* if, for every vector fields  $Y, Z$ ,

$$(L_X g)(Y, Z) = g(\nabla_Y X, Z) + g(\nabla_Z X, Y) = 0.$$

Equivalently, the flow  $\phi(x, t)$  of  $X$  is a local 1-parameter group of isometries:

$$\phi_t^* g = g.$$

Note that, by the very definition, any Killing vector field  $X$  satisfies

$$\text{div } X = 0.$$

Note also that if  $X$  is a Killing vector field on  $(M, g)$ , which is pointwise tangential to an embedded submanifold  $P$ , then  $X|_P$  is a Killing vector field of  $P$ .

Now, let  $\bar{\Omega}$  be a homogeneous domain with group  $G$  and whose regular leaves are homogeneous hypersurfaces  $\Sigma_t$  and recall it has at most two singular leaves  $P_1$  and  $P_2$ . Consider the Riemannian submersion given by the projection

$$\begin{array}{ccc} \pi : \bar{\Omega} \setminus (P_1 \cup P_2) & \longrightarrow & \mathbb{R} \\ \Sigma_t & \longmapsto & \Sigma_t/G = \text{point} \end{array}$$

and note that

$$\mathcal{V}_p = T_p \Sigma_t \quad \forall p \in \Sigma_t \tag{2.2.1}$$

where  $\mathcal{V}_p = \text{Ker}(d_p \pi)$  is the vertical space at  $p$ . For any  $p \in \Sigma_t$  the space  $\mathcal{V}_p$  is spanned by the set  $\mathfrak{K}(\bar{\Omega})$  of all Killing vector fields of  $\bar{\Omega}$  evaluated at  $p$ . These, in turn, identify with the elements of the Lie algebra  $\mathfrak{g}$  of  $G$  via the map

$$\begin{array}{ccc} \mathfrak{g} & \longrightarrow & \mathfrak{K}(\bar{\Omega}) \\ \mathfrak{X} & \longmapsto & X \end{array}$$



where

$$X : p \mapsto \left. \frac{d}{dt} \right|_{t=0} \left( \exp(t\mathfrak{X})(p) \right).$$

Thus, letting  $m - 1 \leq k = \dim G \leq m(m - 1)/2$ , we can select a distribution of linearly independent Killing vector fields

$$\mathcal{D} = \{X_1, \dots, X_k\} \subseteq \mathfrak{K}(\bar{\Omega})$$

whose integral manifolds are the hypersurfaces  $\Sigma_t$ . For further information on the topic we suggest [80].

### 2.2.3 Examples

It is time to present a brief list of concrete examples of isoparametric and homogenous domains.

**Example 2.2.3** (Balls in model manifolds). Let  $\mathbb{M}_\sigma^n = [0, R) \times_\sigma \mathbb{S}^{n-1}$  be a model manifold, where  $R \in (0, +\infty]$ . Then, geodesic balls centred at the pole are homogeneous domains with the homogeneous foliation provided by the geodesic spheres concentric to the pole. The corresponding group is  $G = \mathbf{SO}(n)$ .

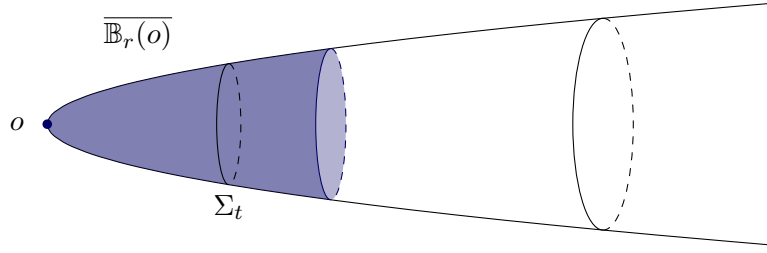

**Example 2.2.4** (Annuli in warped products). Take a warped product manifold  $M = I \times_\sigma N$  where  $(N, g^N)$  is an  $(m - 1)$ -dimensional Riemannian manifold without boundary,  $I \subset \mathbb{R}$  is a real open interval and  $\sigma(t) > 0$  is a smooth function on  $I$ . Explicitly, the Riemannian metric  $g$  of  $M$  is given by

$$g = dt \otimes dt + \sigma^2(t)g^N.$$

Take a domain either of the form  $\bar{\Omega} = [a, b] \times N$  or  $\bar{\Omega} = [a, +\infty) \times N$ . Since the (translated)  $t$ -coordinate  $r(t, \xi) = t - a$  is precisely the (absolute) distance function from the hypersurface  $\Sigma_a = \{a\} \times N \hookrightarrow M$  we have that

$$|\nabla r| = 1$$

and the level sets

$$\Sigma_t = r^{-1}(t - a) = \{t\} \times N,$$

with  $a \leq t \leq b$ , are parallel hypersurfaces. Moreover, the second fundamental form and the mean curvature of  $\Sigma_t$  with respect to Gauss map  $\vec{\nu} = \nabla r$  are given, respectively, by

$$\Pi^{\Sigma_t} = \text{Hess}(r)|_{\Sigma_t} = \sigma'(t)\sigma(t)g^N$$

and

$$H^{\Sigma_t} = \Delta r = (m-1) \frac{\sigma'}{\sigma}(t) = (m-1) \frac{\sigma'}{\sigma}(r+a).$$

It follows that  $r$  is an isoparametric function turning  $\bar{\Omega}$  into an isoparametric domain. We note explicitly that each leaf  $\Sigma_t$  is totally umbilical (namely, the traceless second fundamental form vanishes identically).

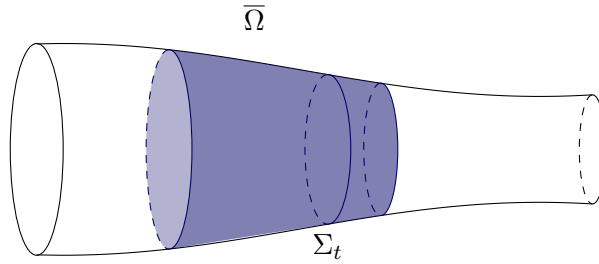

In case  $(N, g^N)$  is a compact Lie group endowed with a left-invariant Riemannian metric, then the domain  $\bar{\Omega} = [a, b] \times N$  inside  $I \times_{\sigma} N$  is homogeneous with group  $N$ . Actually the same holds if  $N = G/H$  is a homogeneous manifold.

**Example 2.2.5** (Annuli in harmonic spaces). Another interesting class of examples is given by the *harmonic manifolds* introduced by A. Lichnerowicz in [68]. This class includes symmetric spaces and Damek-Ricci spaces. We are grateful to the referee for pointing this out to us.

A Riemannian manifold  $(M, g)$  is *locally harmonic* if, for every  $p \in M$  there exist a radius  $\epsilon(p) > 0$  and a function  $\omega_p : [0, \epsilon(p)) \rightarrow \mathbb{R}$  such that, in exponential polar coordinates  $(r, \xi)$  around  $p$ , the volume density takes the form  $A(r, \xi) = \omega_p(r)$ , for every  $r \in (0, \epsilon(p))$ . Actually, a-posteriori, the function  $\omega_p$  is independent of the reference point and defined on the maximal interval  $[0, \max_{p \in M} \epsilon(p)) \subseteq [0, +\infty)$ . The locally harmonic manifold  $(M, g)$  is called *globally harmonic* if it is geodesically complete and  $\epsilon \equiv +\infty$ . Let us assume that  $(M, g)$  is globally harmonic. From the rotational symmetry of the volume density one immediately deduces that:

- a) The conjugate locus of a point  $p \in M$  is nonempty only if  $M$  is compact.
- b) Since, within the cut-locus, the Laplacian of the distance function  $r(x) = d^M(x, p)$  satisfies  $\Delta r = \partial_r \log A$ , then  $\Delta r = (\omega'/\omega)(r)$  is rotationally symmetric.

It follows from the Hadamard-Cartan theorem that a complete, non-compact, simply connected, globally harmonic manifold is diffeomorphic to  $\mathbb{R}^n$  and the smooth distance function  $r$  from a fixed origin  $p$  is a (global) isoparametric function. In particular any annulus inside  $M$  is an isoparametric domain. Needless to say, small enough annuli in locally harmonic spaces enjoy the same property.

Simply connected, complete, non-compact, globally harmonic spaces are also *asymptotically harmonic*. This means that the isoparametric property of the distance function is inherited

by the Busemann function with respect to any given geodesic line. More precisely, the Busemann function has unit gradient and constant Laplacian. In particular, any *horospherical annulus* is an isoparametric domain whose leaves are complete, non-compact, hypersurfaces with the same constant mean curvature. For more information concerning harmonic and asymptotically harmonic manifolds we refer the reader to [13], [66], [91] and references therein.

**Example 2.2.6** (Euclidean homogenous domains with non-compact leaves). Taking the Euclidean space  $\mathbb{R}^n$  we easily obtain two different types of isoparametric domains with non-compact leaves:

- *Cylindrical annuli*: consider the tube whose equidistants are the right cylinders  $\{\Sigma_t\}_{t \in (a,b)}$  with axis given by a straight line  $a$  through the origin  $o \in \mathbb{R}^n$ . Thanks to the isotropy of the Euclidean space, we can suppose that  $a = \mathbb{R}\vec{e}_n = \mathbb{R}(0, \dots, 0, 1)$ . Then, each leaf takes the form

$$\Sigma_t = \{(x', x_n) \in \mathbb{R}^n \mid x' \in \mathbb{S}_t^{n-2}, x_n \in \mathbb{R}\}$$

for  $\mathbb{S}_t^{n-2}$  the  $(n-2)$ -sphere of radius  $t$ , centred at the origin.

In this way we obtain an isoparametric foliation of the domain  $\bar{\Omega} = \cup_{t \in [a,b]} \Sigma_t$  with leaves that have constant mean curvature equal to  $H^{\Sigma_t} = \frac{n-2}{t}$ . A possible isoparametric function is

$$f(x_1, \dots, x_n) = \sqrt{x_1^2 + \dots + x_{n-1}^2} = |x'|$$

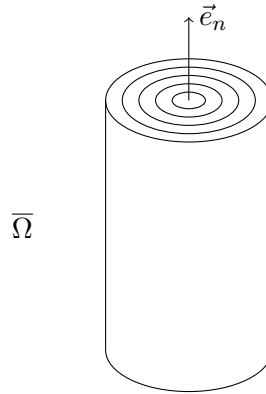

- *Slabs*: consider the tube whose equidistants are the hyperplanes  $\{\Sigma_t\}_{t \in (a,b)}$  parallel to

$$\Sigma_0 = \{x \in \mathbb{R}^n \mid x \cdot \vec{v}_0 = 0\}$$

for a fixed vector  $\vec{v}_0 \in \mathbb{S}^{n-1}$ .

As before, we can suppose  $\vec{v}_0 = \vec{e}_n$ . Then, the leaves are

$$\Sigma_t = \Sigma_0 + t\vec{v}_0 = \{(x', t) \mid x' \in \mathbb{R}^{n-1} \equiv \Sigma_0\}$$

These hyperplanes give the domain  $\bar{\Omega} = \cup_{t \in [a,b]} \Sigma_t$  an isoparametric structure, whose leaves have vanishing mean curvature. A possible isoparametric function is

$$f(x_1, \dots, x_n) = x_n$$

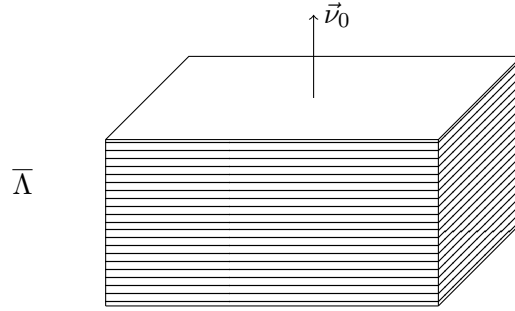

In both cases, the domain  $\bar{\Omega}$  is homogeneous with groups, respectively,  $G = \mathbf{SO}(n)$  and  $G = \mathbb{R}^{n-1}$ .

**Example 2.2.7** (Generalized Hopf-Fibration). Let  $M = \mathbb{S}^3$  and  $F(x) = x_1^2 + x_2^2 - x_3^2 - x_4^2$  be the Cartan-Munzner polynomial that gives rise to Clifford tori  $T(r) = \mathbb{S}^1(r) \times \mathbb{S}^1(\sqrt{1-r^2})$  with  $0 < r < 1$ . Then  $F^{-1}([t_1, t_2])$  is a homogeneous domain by the action of  $G = \mathbf{SO}(2) \times \mathbf{SO}(2)$ . Similar examples can be constructed in the higher dimensional spheres  $\mathbb{S}^n$ , using the isoparametric functions  $F(x) = l(x_1^2 + \dots + x_k^2) - k(x_{k+1}^2 + \dots + x_n^2)$  for  $k+l = n+1$ . Note that the leaves of these isoparametric domains are not totally umbilical (and, in particular, they have not a warped product structure of the form  $I \times_\sigma N$ ).

**Example 2.2.8** (Cartan homogenous domains). Tubes around tori are just one of the possible families of examples of homogenous domains in the sphere  $\mathbb{S}^m$ . For different choices of the Cartan-Munzner polynomial, corresponding to different choices of the Lie subgroup  $G \subset \mathbf{SO}(m+1)$ , we refer to [99]. An account of more examples, in different ambient spaces, can be found in [32].

## 2.2.4 Weighted symmetric domains

When formulated in the context of a weighted Riemannian manifold  $M_\Psi$ , the notion of isoparametric domain can be naturally generalized as follows.

Recall that, given a smooth hypersurface  $\Sigma$  oriented by  $\vec{\nu}$  inside the weighted manifold  $M_\Psi$ , its *weighted mean curvature* (in the sense of Gromov)  $\vec{H}_\Psi = H_\Psi \vec{\nu}$  is given by

$$H_\Psi = H - g(\nabla \Psi, \vec{\nu})$$

where  $\vec{H} = H\vec{\nu}$  is the usual mean curvature vector field, i.e., the (unnormalized) trace of the second fundamental form.

**Definition 2.2.9** ( $\Psi$ -isoparametric domain). *Let  $M_\Psi$  be a weighted Riemannian manifold. A  $\Psi$ -isoparametric domain  $\bar{\Omega} \subseteq M_\Psi$  is a domain of  $M_\Psi$  endowed with a singular Riemannian*

foliation  $\bar{\Omega} = \cup_t \Sigma_t$  whose regular leaves (i.e. those of maximal dimension) are connected parallel complete hypersurfaces (without boundary) with constant mean curvature and with at most two singular (i.e. of codimension greater than one) leaves.

Similarly to the unweighted case,  $\Psi$ -isoparametric domains arise as domains foliated by the level sets of  $\Psi$ -isoparametric functions, that are smooth functions  $f$  whose norm of the gradient and whose weighted Laplacian can be expressed in terms of  $f$  itself

$$|\nabla f|^2 = \alpha(f) \quad \text{and} \quad \Delta_\Psi f = \beta(f),$$

for  $\alpha$  smooth and  $\beta$  continuous in the range of  $f$ .

The notion of a homogeneous domain can be extended to the weighted setting using a similar spirit. In this case, however, it is not a-priori clear how to incorporate the weighted structure into the homogeneity condition. We choose to adopt the following

**Definition 2.2.10** ( $\Psi$ -homogeneous domain). *Let  $M_\Psi$  be a weighted Riemannian manifold. Say that  $\bar{\Omega}$  is a  $\Psi$ -homogeneous domain if it is a  $\Psi$ -isoparametric domain and a homogeneous domain simultaneously. Equivalently,  $\bar{\Omega}$  is  $\Psi$ -homogeneous if it is a homogeneous domain satisfying the “weight compatibility condition”*

$$g(\nabla \Psi, \vec{\nu}) = \text{const} \quad \text{on each leaf } \Sigma_t \tag{2.2.2}$$

The equivalence of these two conditions come from the very definition of weighted mean curvature and the fact that a homogeneous domain has constant (ordinary) mean curvature.

**Remark 2.2.11** (From homogeneous to  $\Psi$ -homogeneous). It is worth noting that, if  $P$  is the soul of  $\bar{\Omega}$  and  $d(x) = d^M(x, P)$ , the natural choice  $\Psi(x) = \hat{\Psi}(d(x))$  turns any(!) homogeneous domain into a  $\Psi$ -homogeneous domain. However, as we shall see, there are interesting  $\Psi$ -homogeneous domains that do not fall in this category. See Example 2.2.13.

**Example 2.2.12.** By definition of  $\Psi$ -symmetry and according to Remark 2.2.11, Examples 2.2.3 and 2.2.4 trivially generalize, respectively, to the case of weighted model manifolds and annuli in weighted warped product manifolds, up to assuming that the weight has the form  $\Psi(x) = \hat{\Psi}(d(x, o))$  and  $\Psi(x) = \hat{\Psi}(d^M(x, \Sigma_a))$ .

**Example 2.2.13** (Gaussian isoparametric domains with non-compact leaves). Take the Gaussian space  $\mathbb{G}^n$ . The weighted mean curvature of a  $\vec{\nu}$ -oriented smooth hypersurface  $\Sigma \subset \mathbb{G}^n$  is

$$H_\Psi = H - g(-x, \vec{\nu}) = H + g(x, \vec{\nu})$$

Using this fact, we can easily generalize the two examples obtained in (2.2.6):

- *Weighted cylindrical annuli:* As done in the non-weighted case, we consider

$$\Sigma_t = \{(x', x_n) \in \mathbb{R}^n \mid x' \in \mathbb{S}_t^{n-2}, x_n \in \mathbb{R}\}$$

for  $\mathbb{S}_t^{n-2}$  the  $(n-2)$ -sphere of radius  $t$ , centred at the origin.

It follows that the normal vector field to the leaf  $\Sigma_t$  is

$$\vec{\nu}_t(x) = \vec{\nu}_t((x', x_n)) = \frac{x'}{|x'|} \quad \forall x \in \Sigma_t$$

where we are identifying  $x'$  with  $(x', 0)$ . So

$$g(x, \vec{\nu}_t(x)) = \frac{|x'|^2}{|x'|} = |x'| = t$$

is constant on each  $\Sigma_t$ . Using this equality and the fact that the mean curvature of  $\Sigma_t$  is  $H(\Sigma_t) = \frac{n-2}{t}$ , we obtain that

$$H_{\Psi}^{\Sigma_t} = \frac{n-2}{t} + t$$

is constant on each  $\Sigma_t$ .

- *Weighted slabs:* As before, let  $\vec{\nu}_0 = \vec{e}_n$  and consider

$$\Sigma_t = \Sigma_0 + t\vec{\nu}_0 = \{(x', t) \mid x' \in \mathbb{R}^{n-1} \equiv \Sigma_0\}$$

with normal vector field to  $\Sigma_t$  given by

$$\vec{\nu}_t(x) = \vec{\nu}_t((x', x_n)) = \frac{(0, x_n)}{|x_n|} = \frac{t}{|t|} \vec{e}_n$$

So

$$g(x, \vec{\nu}_t(x)) = \frac{|x_n|^2}{|x_n|} = |x_n| = t$$

and thus

$$H_{\Psi}^{\Sigma_t} = H^{\Sigma_t} + t = t$$

is constant on each  $\Sigma_t$ .

In particular, both weighted cylindrical annuli and weighted slabs are  $\Psi$ -homogeneous domains whose weight  $\Psi$  is not symmetric.

**Example 2.2.14** (Gaussian-like weighted spaces). Consider the weighted space  $\mathbb{R}_{\Psi}^n = (\mathbb{R}^n, g^{\mathbb{R}^n}, e^{-\Psi} dx)$  for a symmetric weight  $\Psi(x) = A|x|^2 + B$  and  $A, B \in \mathbb{R}$ ,  $A \neq 0$ . Then, the previous examples with non-compact leaves (parallel hyperplanes and coaxial cylinders) and the spherical tube continue to be  $\Psi$ -homogeneous domains.

Indeed, the gradient of the weight is

$$\nabla \Psi(x) = 2Ax$$

and following the previous calculations, we obtain that the weighted mean curvature of each equidistant of the above mentioned domains is constant.

## 2.3 Symmetric functions

Laid the foundations of the theory of isoparametric domains, we must specify what we mean by *symmetry* when we talk about functions defined on them. Accordingly, one introduces the *average operator*

$$\mathcal{A}_\Psi(u)(x) = \frac{1}{\text{area}_\Psi \Sigma_t(x)} \int_{\Sigma_t(x)} u(y) \, \text{da}_\Psi \quad (2.3.1)$$

and put the following

**Definition 2.3.1** (Symmetric function). *Let  $\bar{\Omega}$  be a compact weighted isoparametric domain inside the weighted manifold  $M_\Psi$ . Say that the function  $u$  on  $\bar{\Omega}$  is symmetric if*

$$u(x) = \mathcal{A}_\Psi(u)(x).$$

**Remark 2.3.2** (Symmetry condition using distance function). If  $\bar{\Omega}$  is a compact  $\Psi$ -isoparametric domain with soul  $P$  and  $d(x) = d^M(x, P)$ , then the following are equivalent:

- (a)  $u = \mathcal{A}_\Psi(u)$ .
- (b)  $u(x) = \hat{u}(d(x))$ .

The advantage of characterization (b) over (a) is that it makes sense even if  $P$  is non-compact and  $u$  is not necessarily integrable on the leaves of the foliation.

One of the main features of weighted isoparametric domains is that the corresponding average operator, that preserves the smoothness of functions, commutes with the weighted Laplacian. This property is formalized in the following Lemma that extends [98, Proposition 13] to the weighted setting.

**Lemma 2.3.3** (Savo). *Let  $\Omega$  be a smooth, compact, weighted isoparametric domain with soul  $P$  inside the weighted manifold  $M_\Psi$ . Let  $\mathcal{A}_\Psi$  be the average operator defined on  $L^1(\Omega, \text{dv}_\Psi)$  by (2.3.1). Then the following hold:*

- (a) *If  $u \in C^{k+2}(\Omega)$ , then  $\mathcal{A}_\Psi(u) \in C^k(\Omega)$ .*
- (b) *Given  $u \in C^4(\Omega)$ ,  $\mathcal{A}_\Psi(\Delta_\Psi u) = \Delta_\Psi \mathcal{A}_\Psi(u)$ .*

**Notation 2.3.4.** For the sake of brevity, we shall write condition (b) as the commutation rule

$$[\mathcal{A}_\Psi, \Delta_\Psi] = 0.$$

A similar convention will be adopted during the chapter for other operators.

The proof is a minor variation of the original one in the Riemannian setting.

### 2.3.1 Local vs global symmetry

The notion of symmetry defined in the previous subsection can be formulated equivalently in terms of a first order condition.

Let  $\bar{\Omega}$  be an isoparametric domain with compact soul  $P$  inside the weighted Riemannian manifold  $M_\Psi$ . We set, as usual,  $d(x) = d^M(x, P)$  so that  $\bar{\Omega} = \cup_{r \in [r_1, r_2]} \Sigma_r$  is foliated by the smooth, embedded, parallel hypersurface  $\Sigma_r = \{x \in M : d(x) = r\}$  in the same isotopy class.

**Definition 2.3.5** (Local symmetry). *Say that  $u \in C^1(\bar{\Omega})$  is symmetric at  $x_0 \in \bar{\Omega}$  if, for any smooth vector field  $X$  on  $\bar{\Omega}$  satisfying*

$$i) X|_{x_0} \neq 0, \quad ii) g(X|_{x_0}, \nabla d(x_0)) = 0,$$

*it holds*

$$X(u)(x_0) = g(X|_{x_0}, \nabla u(x_0)) = 0.$$

*In case  $u$  is symmetric at every point  $x \in \bar{\Omega}$  we say that  $u$  is locally symmetric on  $\bar{\Omega}$ .*

**Remark 2.3.6.** Clearly, the local symmetry at  $x_0$  can be formulated in either of the following equivalent ways.

i) Let  $(\nabla u(x_0))^\top$  denote the orthogonal projection of  $\nabla u(x_0)$  on the tangent space  $T_{x_0} \Sigma_{d(x_0)}$ . Then

$$(\nabla u(x_0))^\top = 0.$$

ii) The gradient of  $u$  at  $x_0$  is parallel to  $\nabla d(x_0)$ :

$$\nabla u(x_0) \in \text{span} \nabla d(x_0) = (T_x \Sigma_{d(x_0)})^\perp.$$

**Lemma 2.3.7.** *Keeping the above notation, the function  $u$  is locally symmetric on  $\bar{\Omega}$  if and only if  $u$  is symmetric in the global sense, i.e.,  $u(x) = \hat{u}(d(x))$ .*

*Proof.* Assume that  $u$  is locally symmetric and suppose by contradiction that there exist  $r \geq 0$  and  $x, y \in \Sigma_r$  such that  $u(x) > u(y)$ . Each leaf  $\Sigma_r$  is connected, therefore we can consider a smooth immersed<sup>2</sup> curve  $\gamma : [0, 1] \rightarrow \Sigma_r$  joining  $\gamma(0) = x$  to  $\gamma(1) = y$ . Since  $u \circ \gamma$  is a  $C^1$  function satisfying  $u \circ \gamma(0) > u \circ \gamma(1)$ , there exists  $\bar{t} \in [0, 1]$  such that

$$g((\nabla u)(\gamma(\bar{t})), \dot{\gamma}(\bar{t})) = \frac{d}{dt}(u \circ \gamma)(\bar{t}) < 0.$$

This contradicts the local symmetry because  $0 \neq \dot{\gamma}(\bar{t}) \in T_{\gamma(\bar{t})} \Sigma_r$ . □

<sup>2</sup>a connected smooth manifold  $N$  can be always endowed with a complete Riemannian metric  $h$ . Therefore, any two given points  $x, y \in N$  are connected by a minimizing  $h$ -geodesic, which is a smooth immersed curve of  $N$ .



## 2.4 Maximum principles, uniqueness and symmetry

Maximum principles for Schrödinger operators and uniqueness issues for solutions to semilinear PDEs permeate the whole theory of symmetry problems and the whole chapter. Therefore, we devote this preliminary section to review briefly these topics both in the compact and in the non-compact settings.

### 2.4.1 Compact maximum principle

In their book [89, Section 5, Theorem 10], Protter-Weinberger introduced a form of the Maximum Principle valid for elliptic operators in the presence of zeroth order terms. Their celebrated result states as follows.

**Proposition 2.4.1** (Compact Maximum Principle). *Let  $M_\Psi = (M, g, dv_\Psi)$  be a compact weighted Riemannian manifold with boundary  $\partial M \neq \emptyset$  and suppose we are given on  $M_\Psi$  the Schrödinger operator  $\mathcal{L} = \Delta_\Psi - q$ , where  $q \in C^0(M)$ . Assume that there exists a function  $\varphi \in C^0(M) \cap C^2(\text{int}(M))$  solution to the problem*

$$\begin{cases} \mathcal{L}\varphi \leq 0 & \text{int } M \\ \varphi > 0 & M \end{cases} \quad (2.4.1)$$

Then, any solution  $u \in C^0(M) \cap W_{\text{loc}}^{1,2}(\text{int } M)$  of

$$\begin{cases} \mathcal{L}u \geq 0 & \text{int } M \\ u \leq 0 & \partial M \end{cases}$$

satisfies  $u \leq 0$  in  $M$ .

*Proof.* Consider the positive part of the function  $u$

$$u_+ = \max\{u, 0\}$$

Then  $u_+$  satisfies

$$\begin{cases} \mathcal{L}u_+ \geq 0 & \text{int } M \\ u_+ = 0 & \partial M; \end{cases}$$

see e.g. [84, Lemma 6.1] for a proof that works in the nonlinear setting. Defining the function  $0 \leq \omega = \frac{u_+}{\varphi}$  on the weighted manifold  $M_\Phi$ , where  $\Phi = \log(\varphi^{-2}) + \Psi$ , we get

$$\begin{cases} \Delta_\Phi \omega \geq 0 & \text{int } M \\ \omega = 0 & \partial M, \end{cases}$$

By the usual maximum principle we obtain  $\omega \leq 0$  in  $M$  that implies  $\omega = 0$  in  $M$ , i.e.  $u_+ = 0$  in  $M$ , as claimed.  $\square$

Observe that for a compact Riemannian manifold with boundary  $M$  there is no loss of generality in assuming that  $M$  is a smooth bounded domain inside a closed Riemannian manifold  $(N, g^N)$ ; [86, Theorem A]. Thus, the existence of a function  $\varphi$  satisfying (2.4.1) is guaranteed under the assumption that  $\lambda_1^{-\mathcal{L}}(M) > 0$ . Indeed, in this case, once  $q$  and  $\Psi$  are extended with the same regularity to  $N$ , we can slightly enlarge  $M$  to some smooth domain  $\Omega \Subset N$  with  $\lambda_1^{-\mathcal{L}}(\Omega) > 0$  and take as  $\varphi$  the restriction to  $M$  of the first eigenfunction on  $\Omega$ . The existence of such a domain  $\Omega$  could be seen as a trivial consequence of a deep continuity property of the Dirichlet eigenvalues with respect to the (Gromov-)Hausdorff convergence. See e.g. the paper [28] by Chenaï for the case of Hausdorff converging uniformly Lipschitz domains of the Euclidean space. However, one can obtain the existence of  $\Omega$  using much more elementary considerations. We are going to provide the arguments for the sake of completeness.

**Lemma 2.4.2.** *Let  $N_\Psi = (N, g^N, dv_\Psi)$  be a complete weighted Riemannian manifold (without boundary) and  $\mathcal{L} = \Delta_\Psi - q$  with  $q \in C^0(N)$ . Let  $D \Subset N$  be a smooth domain such that  $\lambda_1^{-\mathcal{L}}(D) > 0$ . Then there exists a smooth domain  $\Omega \Subset N$  satisfying  $\lambda_1^{-\mathcal{L}}(\Omega) > 0$ .*

*Proof.* Consider a sequence of nested smooth domains  $N \supseteq \Omega_1 \supseteq \Omega_2 \supseteq \dots \supseteq \Omega_n \supseteq \Omega_{n+1} \dots \supseteq D$  satisfying  $\bigcap_n \Omega_n = \bar{D}$  and let  $Q_n$  and  $Q$  be the quadratic forms associated to the Rayleigh quotient on  $\Omega_n$  and on  $D$  respectively

$$\begin{aligned} Q_n(u) &:= \int_{\Omega_n} (|\nabla u|^2 + qu^2) \, dv_\Psi, & u \in W_0^{1,2}(\Omega_n, dv_\Psi) \\ Q(u) &:= \int_D (|\nabla u|^2 + qu^2) \, dv_\Psi, & u \in W_0^{1,2}(D, dv_\Psi). \end{aligned}$$

By the domain monotonicity of the first Dirichlet eigenvalue we have

$$\lambda_1^{-\mathcal{L}}(D) \geq \lambda_1^{-\mathcal{L}}(\Omega_n), \quad \forall n \in \mathbb{N}.$$

Therefore, if  $\{u_n\}_n \subset C^\infty(\bar{\Omega}_n)$  is the sequence of first Dirichlet eigenfunctions corresponding to  $\lambda_1^{-\mathcal{L}}(\Omega_n)$ , normalized so to have

$$\begin{cases} u_n \geq 0 & \text{in } \Omega_n \\ \|u_n\|_{L^2(\Omega_n, dv_\Psi)} = 1, \end{cases}$$

then, by extending each  $u_n$  to 0 in  $\Omega_1 \setminus \Omega_n$  so that  $u_n \in W_0^{1,2}(\Omega_1)$ , we get

$$\begin{cases} \|\nabla u_n\|_{L^2(\Omega_1, dv_\Psi)}^2 = \|\nabla u_n\|_{L^2(\Omega_n, dv_\Psi)}^2 \\ \|u_n\|_{L^2(\Omega_1, dv_\Psi)} = \|u_n\|_{L^2(\Omega_n, dv_\Psi)} = 1 \\ Q_1(u_n) = Q_n(u_n) = \lambda_1^{-\mathcal{L}}(\Omega_n) \leq \lambda_1^{-\mathcal{L}}(D). \end{cases}$$

In particular

$$\begin{aligned} \|\nabla u_n\|_{L^2(\Omega_1, dv_\Psi)}^2 &= \lambda_1^{-\mathcal{L}}(\Omega_n) - \int_{\Omega_n} qu_n^2 \, dv_\Psi \\ &\leq \lambda_1^{-\mathcal{L}}(D) + \|q\|_{L^\infty(\Omega_1, dv_\Psi)}. \end{aligned}$$

We have deduced that  $\{u_n\}_n$  is a bounded sequence in  $W_0^{1,2}(\Omega_1, dv_\Psi)$ . Then there exists a subsequence  $\{u_{n_k}\}_k$  converging weakly in  $W_0^{1,2}(\Omega_1, dv_\Psi)$  and strongly in  $L^2(\Omega_1, dv_\Psi)$  to some function  $v \in W_0^{1,2}(\Omega_1, dv_\Psi)$ . Clearly,

$$\|v\|_{L^2(\Omega_1, dv_\Psi)} = 1.$$

Moreover, since we can always assume that  $u_{n_k} \xrightarrow{a.e.} v$  and, by assumption,  $\bigcap_n \Omega_n = \bar{D}$ , we have  $v = 0$  a.e. on  $\Omega_1 \setminus \bar{D}$ . But, in fact,

$$v = 0 \text{ a.e. on } \Omega_1 \setminus D$$

because the smooth boundary  $\partial D$  of  $D$  has measure zero. It follows from [7, Proposition 2.11] that

$$v \in W_0^{1,2}(D)$$

and thus

$$\lambda_1^{-\mathcal{L}}(D) \leq Q(v) = Q_1(v).$$

Now, using the lower semicontinuity of the quadratic form  $Q_1$  with respect to the weak  $W^{1,2}$ -topology, we obtain

$$\begin{aligned} Q_1(v) &\geq \lambda_1^{-\mathcal{L}}(D) \\ &\geq \limsup_k \lambda_1^{-\mathcal{L}}(\Omega_{n_k}) \\ &\geq \liminf_k \lambda_1^{-\mathcal{L}}(\Omega_{n_k}) \\ &= \liminf_k Q_1(u_{n_k}) \\ &\geq Q_1(v), \end{aligned}$$

showing that

$$\lim_k \lambda_1^{-\mathcal{L}}(\Omega_{n_k}) = \lambda_1^{-\mathcal{L}}(D) > 0.$$

The desired conclusion now follows by choosing  $\Omega = \Omega_{k_0}$  with  $k_0$  large enough.  $\square$

As a consequence of Proposition 2.4.1 and Lemma 2.4.2, on noting also that if  $\lambda_1^{-\mathcal{L}}(\text{int } M) = 0$  then the corresponding first Dirichlet eigenfunction  $u \geq 0$  violates the maximum principle, we have the validity of the following well known characterization.

**Corollary 2.4.3.** *Let  $M_\Psi = (M, g, dv_\Psi)$  be a compact weighted Riemannian manifold with smooth boundary. Then, the compact maximum principle of Proposition 2.4.1 for the Schrödinger operator  $\mathcal{L}$  holds if and only if  $\lambda_1^{-\mathcal{L}}(\text{int } M) > 0$ .*

When specified to the stability operator, the previous result takes the following form.

**Corollary 2.4.4.** *Let  $M_\Psi = (M, g, dv_\Psi)$  be a compact weighted Riemannian manifold with smooth boundary  $\partial M \neq \emptyset$ . Assume that  $u \in C^0(M) \cap C^2(\text{int } M)$  is a strongly stable solution to  $\Delta_\Psi u = f(u)$  on  $M$ . If  $v \in C^0(M) \cap W_{\text{loc}}^{1,2}(\text{int } M)$  satisfies*

$$\begin{cases} \Delta_\Psi v \geq f'(u)v & \text{int } M \\ v \leq 0 & \partial M \end{cases}$$

then  $v \leq 0$  on  $M$ .

### 2.4.2 Non-compact maximum principle: parabolicity

Let  $M_\Psi$  be a (connected) weighted manifold with (possibly empty) boundary  $\partial M$  and outward pointing unit normal  $\vec{\nu}$ . Say that  $M_\Psi$  is *Neumann-parabolic* ( $\mathcal{N}$ -parabolic for short) if, for any given  $v \in C^0(M) \cap W_{loc}^{1,2}(\text{int } M, dv_\Psi)$  satisfying

$$\begin{cases} \Delta_\Psi v \geq 0 & \text{int } M \\ \partial_{\vec{\nu}} v \leq 0 & \partial M \\ \sup_M v < +\infty \end{cases}$$

it holds

$$v \equiv \text{const.}$$

Obviously, in case  $\partial M = \emptyset$ , the normal derivative condition is void.

In order to give an alternative (and equivalent) definition of the  $\mathcal{N}$ -parabolicity, we first recall that the *capacity* of a compact set  $K \subset M_\Psi$  is defined as

$$\text{cap}_\Psi K := \inf \left\{ \int_M |\nabla u|^2 \, dv_\Psi : u \in C_c^\infty(M), u \geq 1 \text{ on } K \right\}.$$

We have the following characterization (see e.g. [60, Theorem 1.5]).

**Theorem 2.4.5.** *Let  $M_\Psi$  be an oriented, connected, weighted Riemannian manifold with nonempty boundary. Then, the following are equivalent*

1.  $\text{cap}_\Psi K = 0$  for every compact set  $K \subset M_\Psi$ ;
2.  $M_\Psi$  is  $\mathcal{N}$ -parabolic.

As the definition shows, parabolicity is a kind of compactness from the viewpoint of the (weighted) Laplacian. This is also visible in the next theorem. Further instances will be presented in Section 2.6.2.

**Theorem 2.4.6** (Ahlfors maximum principle, [60, 59]). *If  $M_\Psi$  is a  $\mathcal{N}$ -parabolic weighted manifold with  $\partial M \neq \emptyset$ , then for any  $v \in C^0(M) \cap W_{loc}^{1,2}(\text{int } M)$  satisfying*

$$\begin{cases} \Delta_\Psi v \geq 0 & \text{int } M \\ \sup_M v < +\infty \end{cases}$$

it holds

$$\sup_M v = \sup_{\partial M} v.$$

Using Theorem 2.4.6, the proof of Proposition 2.4.1 extends to the context of non-compact parabolic Riemannian manifolds: in addition, we only have to require suitable bounds on the functions  $u$  and  $\varphi$ :

**Proposition 2.4.7.** (*Non-Compact Maximum Principle*) Let  $M_\Psi = (M, g, dv_\Psi)$  be a  $\mathcal{N}$ -parabolic weighted Riemannian manifold with boundary  $\partial M \neq \emptyset$  and set  $\mathcal{L} = \Delta_\Psi - q$  with  $q \in C^0(M)$ . Assume that there exists  $\varphi \in C^2(M)$  satisfying

$$\begin{cases} \mathcal{L}\varphi \leq 0 & \text{int } M \\ \varphi \leq C & M \end{cases} \quad (2.4.2)$$

for some constant  $C \geq 1$ . Then, any solution  $u \in C^0(M) \cap W_{\text{loc}}^{1,2}(\text{int } M)$  of

$$\begin{cases} \mathcal{L}u \geq 0 & \text{int } M \\ u \leq 0 & \partial M \\ \sup_M u < +\infty \end{cases}$$

satisfies  $u \leq 0$  in  $M$ .

*Proof.* Note that, thanks to the bounds on  $\varphi$ , defining  $\Phi = \log(\varphi^{-2}) + \Psi$  as in the compact case, the weighted manifold  $M_\Phi$  inherits the  $\mathcal{N}$ -parabolicity of  $M_\Psi$ . For instance, this can be seen by using the capacity characterization of parabolicity as explained in Theorem 2.4.5. Therefore, the proof of Proposition 2.4.1 can be carried out verbatim up to replacing the classical maximum principle for the operator  $\Delta_\Phi$  with the corresponding Ahlfors Maximum Principle of Theorem 2.4.6.  $\square$

### 2.4.3 Uniqueness

It is well known that, for convex or concave nonlinearities, stable solutions to the corresponding semilinear equations on compact domains are (essentially) unique. More precisely, we recall the following result from [34, Proposition 1.3.1].

**Theorem 2.4.8.** Let  $M_\Psi = (M, g, dv_\Psi)$  be a compact weighted Riemannian manifold with boundary components  $(\partial M)_j \neq \emptyset$ ,  $j = 1, 2$ . Let  $f : \mathbb{R} \rightarrow \mathbb{R}$  be a  $C^2$  function satisfying either  $f''(t) \leq 0$  or  $f''(t) \geq 0$ . Then, the boundary value problem

$$\begin{cases} \Delta_\Psi u = f(u) & \text{int } M \\ u = c_j \in \mathbb{R} & (\partial M)_j \end{cases} \quad (2.4.3)$$

has at most one  $C^2(M)$ -stable solution unless  $f(t) = -\lambda_1 t + c$ , with  $\lambda_1 = \lambda_1^{-\Delta_\Psi}(M) > 0$  the first Dirichlet eigenvalue. In this case, if  $u_1$  and  $u_2$  are two solutions, then  $u_1 - u_2 = \alpha \varphi_1$ , where  $\alpha \in \mathbb{R}$  and  $\varphi_1$  is a first Dirichlet eigenfunction of  $-\Delta_\Psi$  on  $M$ .

We are going to show how the proof of this uniqueness property extends to complete manifolds under a global Sobolev regularity condition. To this end, we first adapt to complete manifolds with boundary the classical global Stokes theorem by Gaffney, [39].

**Theorem 2.4.9** (Gaffney with boundary). Let  $M_\Psi = (M, g, dv_\Psi)$  be a complete weighted Riemannian manifold with (possibly empty) boundary  $\partial M$ . Let  $X$  be a vector field on  $M$  such that:

$$i) |X| \in L^1(M, dv_\Psi), \quad ii) \operatorname{div}_\Psi(X) \in L^1(M, dv_\Psi), \quad iii) g(X, \vec{\nu}) \in L^1(\partial M, dv_\Psi),$$

where  $\vec{\nu}$  is the outward-pointing unit normal to  $\partial M$ . Then

$$\int_M \operatorname{div}_\Psi(X) \, dv_\Psi = \int_{\partial M} g(X, \vec{\nu}) \, da_\Psi.$$

*Proof.* It is a consequence of the Riemannian extension property of complete manifolds that, even for manifolds with boundary, the completeness of  $M$  implies the existence of a sequence of cutoff functions  $\{\rho_k\}_k \subset C_c^\infty(M)$  satisfying

$$\begin{cases} 0 \leq \rho_k \leq 1 \\ \|\nabla \rho_k\|_{L^\infty(M, dv)} \rightarrow 0 \\ \rho_k \nearrow 1. \end{cases} \quad (2.4.4)$$

See [86, Page 16]. Since the vector field  $\rho_k X$  is compactly supported, by the classical (weak) divergence theorem we have

$$\int_M \operatorname{div}_\Psi(\rho_k X) \, dv_\Psi = \int_{\partial M} g(\rho_k X, \vec{\nu}) \, da_\Psi.$$

On the other hand,

$$\int_M \operatorname{div}_\Psi(\rho_k X) \, dv_\Psi = \int_M g(\nabla \rho_k, X) \, dv_\Psi + \int_M \rho_k \operatorname{div}_\Psi(X) \, dv_\Psi.$$

Whence, we obtain

$$\int_{\partial M} g(\rho_k X, \vec{\nu}) \, da_\Psi = \int_M g(\nabla \rho_k, X) \, dv_\Psi + \int_M \rho_k \operatorname{div}_\Psi(X) \, dv_\Psi. \quad (2.4.5)$$

To conclude the validity of (2.4.5) we take the limit as  $k \rightarrow +\infty$  once we have noted that, by dominated convergence,

$$\int_M \rho_k \operatorname{div}_\Psi(X) \, dv_\Psi \rightarrow \int_M \operatorname{div}_\Psi(X) \, dv_\Psi$$

and

$$\int_{\partial M} g(\rho_k X, \vec{\nu}) \, da_\Psi \rightarrow \int_{\partial M} g(X, \vec{\nu}) \, da_\Psi$$

while

$$\left| \int_M g(\nabla \rho_k, X) \, dv_\Psi \right| \leq \|\nabla \rho_k\|_{L^\infty(M, dv)} \|X\|_{L^1(M, dv_\Psi)} \rightarrow 0.$$

□

Using this global divergence theorem, we can now extend to complete manifolds the uniqueness result of Theorem 2.4.8.

**Theorem 2.4.10.** *Let  $M_\Psi = (M, g, dv_\Psi)$  be a complete weighted Riemannian manifold with boundary  $\partial M \neq \emptyset$ , and  $u_1, u_2 \in C^0(M) \cap W^{1,2}(\text{int } M, dv_\Psi) \cap L^\infty(M)$  be stable solutions to (2.4.3) with  $f \in C^1$  concave (or convex). Then  $u_1 = u_2$  unless  $f(t) = At + B$  for some  $A, B \in \mathbb{R}$ .*

*Proof.* Observe that  $\omega = u_2 - u_1$  solves

$$\begin{cases} \Delta_\Psi \omega = f(u_2) - f(u_1) & \text{in int } M \\ \omega = 0 & \text{on } \partial M, \end{cases} \quad (2.4.6)$$

Let  $\omega_+ = \max(\omega, 0) \in W^{1,2}(\text{int } M) \cap C^0(M)$ . Using a standard approximation argument that relies on the completeness of  $M$ , we easily see that

$$\omega_+ \in W_0^{1,2}(\text{int } M).$$

Indeed, let  $\{\rho_k\}_k \subset C_c^\infty(M)$  be the sequence of cutoff functions introduced in Theorem 2.4.9 and consider the corresponding sequence  $\{\varphi_k = \rho_k \omega_+\}_k \subset W_0^{1,2}(\text{int } M)$ . Since, by dominated convergence,  $\varphi_k \xrightarrow{L^2} \omega_+$  and, moreover,

$$\begin{aligned} \int_M |\nabla(\varphi_k - \omega_+)|^2 dv_\Psi & \\ \leq \underbrace{2 \int_M |\omega_+|^2 |\nabla \rho_k|^2 dv_\Psi}_{\xrightarrow{DCT} 0} + \underbrace{2 \int_M (1 - \rho_k)^2 |\nabla \omega_+|^2 dv_\Psi}_{\xrightarrow{MCT} 0} & \longrightarrow 0 \end{aligned}$$

we have  $\varphi_k \xrightarrow{W^{1,2}} \omega_+$ . The claimed property thus follows from the fact that  $W_0^{1,2}(\text{int } M)$  is a closed subspace of  $W^{1,2}(\text{int } M)$ .

Now consider the vector field  $X = \omega_+ \nabla \omega_+$ . By the very definition,  $X$  and  $\text{div}_\Psi(X)$  are  $L^1$ -functions and  $X$  vanishes on the boundary  $\partial M$ . Thus, we can apply Theorem 2.4.9 obtaining

$$\int_M |\nabla \omega_+|^2 dv_\Psi = - \int_M (f(u_2) - f(u_1)) \omega_+ dv_\Psi. \quad (2.4.7)$$

On the other hand, since  $u_2$  is a stable solution, using  $\varphi_k = \rho_k \omega_+ \in W_0^{1,2}(M, dv_\Psi)$  as test functions in the stability condition, we obtain

$$\int_M |\nabla \varphi_k|^2 dv_\Psi \geq - \int_M f'(u_2) \varphi_k^2 dv_\Psi$$

where

$$\begin{aligned} \int_M |\nabla \varphi_k|^2 dv_\Psi &= \underbrace{\int_M \rho_k^2 |\nabla \omega_+|^2 dv_\Psi}_{\xrightarrow{MCT} \int_M |\nabla \omega_+|^2 dv_\Psi} + \underbrace{\int_M \omega_+^2 |\nabla \rho_k|^2 dv_\Psi}_{\xrightarrow{DCT} 0} \\ &+ 2 \underbrace{\int_M \rho_k \omega_+ g(\nabla \rho_k, \nabla \omega_+) dv_\Psi}_{=c_k} \end{aligned}$$

and

$$|c_k| \leq 2 \underbrace{\left( \int_M \rho_k^2 |\nabla \omega_+|^2 |\nabla \rho_k|^2 \, dv_\Psi \right)^{\frac{1}{2}}}_{\xrightarrow{DCT} 0} \left( \int_M \omega_+^2 \, dv_\Psi \right)^{\frac{1}{2}}.$$

Thus

$$\int_M |\nabla \varphi_k|^2 \, dv_\Psi \rightarrow \int_M |\nabla \omega_+|^2 \, dv_\Psi.$$

Moreover

$$-\int_M f'(u_2) \varphi_k^2 \, dv_\Psi = -\int_M f'(u_2) \rho_k^2 \omega_+^2 \, dv_\Psi \xrightarrow{DCT} -\int_M f'(u_2) \omega_+^2 \, dv_\Psi.$$

It follows that

$$\int_M |\nabla \omega_+|^2 \, dv_\Psi \geq -\int_M f'(u_2) \omega_+^2 \, dv_\Psi$$

and this latter, together with (2.4.7), implies

$$-\int_M f'(u_2) \omega_+^2 \, dv_\Psi \leq -\int_M (f(u_2) - f(u_1)) \omega_+ \, dv_\Psi$$

i.e.

$$\int_M (f(u_2) - f(u_1) - f'(u_2) \omega_+) \omega_+ \, dv_\Psi \leq 0.$$

Since, by concavity, the above integrand is nonnegative we deduce that

$$(f(u_2) - f(u_1) - f'(u_2) \omega_+) \omega_+ = 0$$

and two possibilities can occur: either  $f(t)$  is strictly concave and, hence,  $w_+ \equiv 0$ , or  $f(t)$  is affine. Clearly, in the first case,  $u_2 \leq u_1$  and by reversing the role of  $u_1$  and  $u_2$  we conclude  $u_1 = u_2$  as desired.  $\square$

#### 2.4.4 Symmetry via average

As a warm-up for the investigations of the present chapter we observe that, clearly, if the boundary value problem at hand

$$\begin{cases} \Delta_\Psi u = f(u) & \text{in } \Omega \\ u = c_j \in \mathbb{R} & \text{on } (\partial\Omega)_j \end{cases} \quad (2.1.1)$$

has a unique solution, and we are able to construct at least one symmetric solution, then we are done. This happens e.g. in the affine setting  $f(t) = At + B$ . Indeed, the equation is



clearly preserved by the average procedure, hence a symmetric solution exists. In order for the maximum principle to hold, we just need to assume that either  $A \geq 0$  or, more generally, that  $\Omega$  is small enough in the spectral sense, i.e.  $\lambda_1^{-\Delta_\Psi + A}(\Omega) > 0$ . Thus, any solution to the corresponding Dirichlet problem (2.1.1) is automatically strictly stable. This is the simplest situation that can occur.

**Proposition 2.4.11.** *Let  $M_\Psi$  be a weighted manifold and let  $\bar{\Omega}$  be a smooth, compact,  $\Psi$ -isoparametric domain. The connected components of its boundary are denoted by  $(\partial\Omega)_j$ ,  $j = 1, 2$ .*

*Let  $u \in C^\infty(\Omega) \cap C^0(\bar{\Omega})$  be a strictly stable solution to the problem*

$$\begin{cases} \Delta_\Psi u = Au + B & \text{in } \Omega \\ u = c_j & \text{on } (\partial\Omega)_j \end{cases} \quad (2.4.8)$$

where  $B, c_j \in \mathbb{R}$ . Then,  $u$  is symmetric.

*Proof.* Using the commutation rule  $[\mathcal{A}_\Psi, \Delta_\Psi] = 0$  we see that the smooth function

$$w = u - \mathcal{A}_\Psi(u)$$

solves the problem

$$\begin{cases} \Delta_\Psi w = Aw & \text{in } \Omega \\ w = 0 & \text{on } \partial\Omega. \end{cases}$$

The maximum principle yields  $w = 0$  which means

$$u = \mathcal{A}_\Psi(u) \quad \text{on } \Omega$$

as desired. □

## 2.5 Symmetry of solutions on $\Psi$ -homogeneous domains

The main result of the section is a geometric interpretation of the arguments in [34, Proposition 1.3.4]. The original symmetry result, for rotationally symmetric domains in the Euclidean spaces, is proved in [3, Lemma 1.1].

**Theorem 2.5.1.** *Let  $\bar{\Omega}$  be a compact  $\Psi$ -homogeneous domain with soul  $P$  inside the weighted manifold  $M_\Psi$ . Moreover, assume that  $\Psi$  is symmetric (at least on  $\bar{\Omega}$ ) and denote with  $\mathcal{D} = \{X_1, \dots, X_k\}$  the integrable distribution of Killing vector fields associated to the foliation of  $\bar{\Omega}$ .*

*Then, any stable solution  $u \in C^3(\Omega) \cap C^1(\bar{\Omega})$  of*

$$\begin{cases} \Delta_\Psi u = f(u) & \text{in } \Omega \\ u = c_j & \text{on } (\partial\Omega)_j \end{cases} \quad (2.5.1)$$

*is symmetric.*

The proof of Theorem 2.5.1 relies on the fact that  $(\Psi)$ -Killing vector fields well behave with respect to the (weighted) Laplace-Beltrami operator. We first recall the following known characterization.

**Lemma 2.5.2.** *Let  $(M, g)$  be a Riemannian manifold. Then, the vector field  $X$  is Killing if and only if the commutation rule  $[\Delta, X] = 0$  holds. This means that, for any smooth function  $u$ ,  $\Delta X(u) = X(\Delta u)$ .*

*Proof.* See [37] for a computational proof that involves generic vector fields. On the other hand, following V. Matveev, the commutation rule can be also deduced directly from the fact that the flow of a Killing vector field is an infinitesimal isometry. Conversely, if the commutation rule holds then the flow of  $X$  preserves the Laplacian and the Laplacian determines uniquely the Riemannian metric.  $\square$

In the special case of a Killing vector field tangential to the leaves of a weighted isoparametric domain with a symmetric weight, the commutation extends to the weighted Laplacian.

**Lemma 2.5.3.** *Let  $\bar{\Omega} \subseteq M_\Psi$  be a  $\Psi$ -isoparametric domain with respect to a symmetric weight  $\Psi$ . If  $X$  is a Killing vector field on  $\bar{\Omega}$  tangential to the leaves of the foliation, then*

$$[\Delta_\Psi, X] = 0 \quad \text{on } \Omega,$$

in the sense that for any smooth function  $u$  on  $\Omega$

$$\Delta_\Psi X(u) = X(\Delta_\Psi u).$$

*Proof.* Recall that

$$\Delta_\Psi u = \Delta u - g(\nabla \Psi, \nabla u)$$

and that, since  $X$  is Killing,

$$[\Delta, X] = 0.$$

Therefore, we are reduced to verify that

$$g(\nabla \Psi, \nabla X(u)) = X(g(\nabla \Psi, \nabla u)). \quad (2.5.2)$$

To this end, let us start by computing

$$\begin{aligned} g(\nabla \Psi, \nabla X(u)) &= g(\nabla \Psi, \nabla g(X, \nabla u)) \\ &= \nabla \Psi(g(X, \nabla u)) \\ &= g(\nabla_{\nabla \Psi} X, \nabla u) + g(X, \nabla_{\nabla \Psi} \nabla u) \\ &= -g(\nabla_{\nabla u} X, \nabla \Psi) + \text{Hess}(u)(X, \nabla \Psi), \end{aligned}$$

where in the last equality we have used that  $X$  is Killing and the definition of the Hessian tensor. Now

$$\begin{aligned} g(X, \nabla \Psi) = 0 &\implies \nabla u(g(X, \nabla \Psi)) = 0 \\ &\implies g(\nabla_{\nabla u} X, \nabla \Psi) + g(X, \nabla_{\nabla u} \nabla \Psi) = 0 \\ &\implies -g(\nabla_{\nabla u} X, \nabla \Psi) = \text{Hess}(\Psi)(X, \nabla u). \end{aligned}$$

Inserting into the above gives

$$g(\nabla\Psi, \nabla X(u)) = \text{Hess}(u)(X, \nabla\Psi) + \text{Hess}(\Psi)(X, \nabla u). \quad (2.5.3)$$

On the other hand,

$$\begin{aligned} X(g(\nabla\Psi, \nabla u)) &= g(\nabla_X \nabla\Psi, \nabla u) + g(\nabla\Psi, \nabla_X \nabla u) \\ &= \text{Hess}(\Psi)(X, \nabla u) + \text{Hess}(u)(X, \nabla\Psi). \end{aligned} \quad (2.5.4)$$

Putting together (2.5.3) and (2.5.4) we conclude the validity of (2.5.2) as desired.  $\square$

We are now in the position to give the

*Proof of Theorem 2.5.1.* Consider a distribution  $\mathcal{D} = \{X_1, \dots, X_k\}$  of Killing vector fields tangential to the leaves of the foliation and satisfying  $g(\nabla\Psi, X_i) = \text{const}$  for every  $i = 1, \dots, k$ . Let  $X = X_j$  and define

$$v = X(u) = g(\nabla u, X).$$

Since  $u$  is locally constant on  $\partial\Omega$  and  $X|_{\partial\Omega}$  is tangential to  $\partial\Omega$ , we have

$$v = 0 \quad \text{on } \partial\Omega.$$

On the other hand, by Lemma 2.5.3 we deduce that

$$\Delta_\Psi v = X(\Delta_\Psi u) = X(f(u)) = f'(u)X(u) = f'(u)v.$$

It follows that  $v \in C^2(\Omega)$  is a solution to the problem

$$\begin{cases} \Delta_\Psi v = f'(u)v & \Omega \\ v = 0 & \partial\Omega. \end{cases}$$

In particular, since by stability  $\lambda_1^{-\Delta_\Psi + f'(u)}(\Omega) = 0 \geq 0$ , it follows that  $\lambda_1^{-\Delta_\Psi + f'(u)}(\Omega) = 0$  and  $v$  is a first eigenfunction corresponding to this Dirichlet eigenvalue. By the nodal domain theorem,

$$v \geq 0.$$

We are going to prove that

$$\int_\Omega v \, dv_\Psi = 0 \quad (2.5.5)$$

and hence

$$v \equiv 0.$$

To this end, we use the  $\Psi$ -divergence theorem with the vector field  $Z = uX$ . Since  $\text{div} X = 0$  and  $X_x$  is tangential to  $\Sigma_{d(x)}$ , on the one hand we have

$$\begin{aligned} \int_\Omega \text{div}_\Psi Z \, dv_\Psi &= \int_\Omega g(\nabla u, X) \, dv_\Psi + \int_\Omega u \text{div}_\Psi X \, dv_\Psi \\ &= \int_\Omega v \, dv_\Psi + \int_\Omega u \text{div} X \, dv_\Psi - \int_\Omega u \underbrace{g(\nabla\Psi, X)}_{=0} \, dv_\Psi \\ &= \int_\Omega v \, dv_\Psi. \end{aligned}$$

On the other hand,

$$\int_{\Omega} \operatorname{div}_{\Psi} Z \, dv_{\Psi} = \int_{\partial\Omega} g(Z, \vec{\nu}) \, da_{\Psi} = \int_{\partial\Omega} u g(X, \pm \nabla d) \, da_{\Psi} = 0,$$

where  $d(x) = \operatorname{dist}(x, P)$ . By putting together these two expressions we obtain

$$\int_{\Omega} v \, dv_{\Psi} = 0,$$

that is, (2.5.5) holds.

We have thus proved that

$$X_j(u)(x_0) = 0, \quad \forall j = 1, \dots, k, \quad \forall x_0 \in \bar{\Omega}.$$

Thanks to the fact that  $\{X_1|_{x_0}, \dots, X_k|_{x_0}\}$  generates  $T_{x_0}\Sigma_{d(x_0)}$ , this implies that  $u$  is locally symmetric, and hence symmetric, on  $\bar{\Omega}$ . The proof of Theorem 2.5.1 is completed.  $\square$

### 2.5.1 The noncompact case

Using the Maximum Principle proved in Theorem 1.2.23, we are able to generalize the symmetry result of Theorem 2.5.1 also in noncompact domains by requiring the strong stability of the solution  $u$ .

**Theorem 2.5.4.** *Let  $\bar{\Omega}$  be a (possibly noncompact)  $\Psi$ -homogeneous domain with soul  $P$  inside the weighted manifold  $M_{\Psi}$ . Moreover, assume that  $\Psi$  is symmetric (at least on  $\bar{\Omega}$ ) and denote with  $\mathcal{D} = \{X_1, \dots, X_k\}$  the integrable distribution of Killing vector fields associated to the foliation of  $\bar{\Omega}$ .*

*Then, every strongly stable solution  $u \in C^3(\Omega) \cap C^1(\bar{\Omega}) \cap W^{1,1}(\Omega)$  to*

$$\begin{cases} \Delta_{\Psi} u = f(u) & \text{in } \Omega \\ u = c_j & \text{on } (\partial\Omega)_j \end{cases} \quad (2.5.6)$$

so that

$$\sup_{\Omega} X_{\alpha}(u) < +\infty \quad \text{and} \quad u|_{X_{\alpha}} \in L^1(\Omega, dv_{\Psi}) \quad \text{for every } \alpha \in \{1, \dots, k\}$$

is symmetric.

*Proof of Theorem 2.5.4.* Let  $X = X_j \in \mathcal{D}$  and define

$$v := X(u).$$

Since  $u$  is locally constant on  $\partial\Omega$  and  $X|_{\partial\Omega}$  is tangential to  $\partial\Omega$ , we have

$$v = 0 \quad \text{on } \partial\Omega.$$

By Lemma 2.5.3

$$\Delta_{\Psi} v = f'(u)v$$

implying that  $v \in C^2(\Omega)$  is a solution to

$$\begin{cases} (\Delta_\Psi - f'(u))v = 0 & \text{in } \Omega \\ v = 0 & \text{on } \partial\Omega \\ \sup_\Omega v < +\infty. \end{cases}$$

and, since  $\lambda_1^{-\Delta_\Psi + f'(u)}(\Omega) > 0$ , by Theorem 1.2.23

$$v \leq 0 \quad \text{in } \Omega. \quad (2.5.7)$$

Let  $Z := uX$ : since  $X$  is Killing, it follows that  $\operatorname{div}X = 0$  implying

$$\operatorname{div}_\Psi Z = e^\Psi \operatorname{div}(e^{-\Psi} Z) = v - \underbrace{g(\nabla\Psi, X)}_{=0} u = v \in L^1(M, dv_\Psi)$$

and, by the fact that  $X_x$  is tangential to  $\Sigma_{d(x)}$ ,

$$g(Z, \vec{\nu}) = 0$$

for  $\nu$  unit vector field normal to  $\partial\Omega$ . Applying Theorem 2.4.9, we get

$$\begin{aligned} \int_\Omega v \, dv_\Psi &= \int_\Omega \operatorname{div}_\Psi Z \, dv_\Psi \\ &= \int_{\partial\Omega} g(Z, \vec{\nu}) \, da_\Psi = 0 \end{aligned}$$

that, together with (2.5.7), implies  $v = 0$  in  $\bar{\Omega}$ .

We have thus proved that  $X_\alpha(u) \equiv 0$  in  $\bar{\Omega}$  for every  $\alpha \in A$ . Thanks to the fact that  $\mathcal{D}$  generates every tangent space to all leaves, it follows that  $u$  is locally symmetric, and hence symmetric, on  $\bar{\Omega}$ .  $\square$

## 2.6 Symmetry of solutions in a non-homogeneous case

In this section we discuss a case where we cannot apply Theorem 2.5.1 due to the absence of enough (if any) Killing vector fields tangential to the leaves of the tube. In fact, recall that, in nonpositive curvature, Killing fields tangential to the (concave) boundary of a domain are trivial as the following classical theorem shows; see [104].

**Theorem 2.6.1** (Weighted Yano-Bochner). *Let  $M_\Psi = (M, g, dv_\Psi)$  be a compact weighted Riemannian manifold with (possibly empty) concave boundary  $\partial M$ . This means that, if  $\vec{\nu}$  denote the outer unit normal to  $\partial M$ , then  $\operatorname{II}(Z, Z) = g(D_Z(-\vec{\nu}), Z) \geq 0$  for every  $Z \in T\partial M$ . Assume also that  $\operatorname{Ric}_\Psi = \operatorname{Ric} + \operatorname{Hess} \Psi \leq 0$ .*

*Then, every Killing vector field  $X$  on  $M$  such that  $X|_{\partial M} \in T\partial M$  and satisfying  $\operatorname{div}_\Psi(X) \equiv \text{const}$  must be parallel. In particular,  $|X| \equiv \text{const}$ . Moreover, if  $\operatorname{Ric}_\Psi < 0$  at some point, then  $X = 0$ .*

*Proof.* The weighted version of Bochner formula for Killing vector fields satisfying  $\operatorname{div}_\Psi(X) \equiv \text{const}$  states that

$$\frac{1}{2}\Delta_\Psi|X|^2 = |\nabla X|^2 - \operatorname{Ric}_\Psi(X, X).$$

Therefore, using the curvature assumption,

$$\Delta_\Psi|X|^2 \geq 0.$$

By the Killing condition and the fact that  $X|_{\partial\Omega}$  is tangential to  $\partial\Omega$  we get

$$\partial_{\bar{\nu}}|X|^2 = -2\Pi(X, X), \quad \text{on } \partial\Omega.$$

It follows that  $v = |X|^2$  is a solution to the problem

$$\begin{cases} \Delta_\Psi v \geq 0 & \Omega \\ \partial_{\bar{\nu}} v = -2\Pi(X, X) \leq 0 & \partial\Omega. \end{cases}$$

By the Hopf Lemma,  $v \equiv \text{const}$ . Using this information into the Bochner formula gives that  $|DX| = 0$ , i.e.  $X$  is parallel, and  $\operatorname{Ric}_\Psi(X, X) = 0$ .  $\square$

**Remark 2.6.2.** For a general Killing vector field, without any request on the  $\Psi$ -divergence, the weighted Bochner formula states that

$$\frac{1}{2}\Delta_\Psi|X|^2 = |\nabla X|^2 - \operatorname{Ric}_\Psi(X, X) + X(g(X, \nabla\Psi))$$

or, equivalently,

$$\frac{1}{2}\Delta_\Psi|X|^2 = |\nabla X|^2 - \operatorname{Ric}_\Psi(X, X) + g(X, \nabla \operatorname{div}_\Psi(X))$$

Thus, the previous Theorem can be slightly generalised to Killing vector fields tangent to the boundary of the manifold and satisfying

$$g(X, \nabla \operatorname{div}_\Psi(X)) \geq 0.$$

**Remark 2.6.3.** Formally, the conclusion of Theorem 2.6.1 can be extended to Killing fields of bounded length on a complete Riemannian manifold with boundary and with quadratic volume growth. See Sections 2.4.2 and 2.6.2.

**Example 2.6.4.** Take the annulus  $A(-1, +1) = [-1, +1] \times N$  inside the Riemannian warped cylinder  $M = \mathbb{R} \times_\sigma N$  where:

- i)  $(N, g^N)$  is compact,  $\partial N = \emptyset$ , and  $\operatorname{Sect}^N \equiv -k^2 < 0$ ;
- ii)  $\sigma'(-1) \leq 0$ ,  $\sigma'(1) \geq 0$ ;
- iii)  $\sigma''(r) \geq 0$  in  $[-1, 1]$ .

We have already observe in Example 2.2.4 that  $A(-1, 1)$  is an isoparametric domain with totally umbilical leaves  $\Sigma_t = \{t\} \times N$ ,  $-1 \leq t \leq 1$ . In particular,

$$\Pi_{\Sigma_{\pm}} = \pm \sigma'(\pm 1) \sigma(\pm 1) g^N.$$

It follows from ii) that

- a)  $\partial A(-1, 1) = \Sigma_{\pm 1}$  is concave.

Moreover, recalling that

$$\text{Sect}_M(X \wedge Y) = \begin{cases} 0 & X, Y = \nabla r \\ -\frac{\sigma''(r)}{\sigma(r)} & X = \nabla r, Y \in TN \\ \frac{-k^2 - \sigma'(r)^2}{\sigma(r)^2} & X, Y \in TN \end{cases}$$

by iii) we have

- b)  $\text{Sect}_M < 0$ .

An application of Theorem 2.6.1 gives that any Killing vector field  $X$  of  $\bar{A}(-1, 1)$  tangential to  $\partial A(-1, 1)$  must vanish identically.

As we are going to show, in the situation of Example 2.6.4 we are still able to deduce a symmetry result. But there is a price to pay: besides the assumption that the solution to the boundary value problem is (strictly) stable, the nonlinearity  $f(t)$  has to be concave. In particular, when the fibre  $N$  is compact, we are in the regime of uniqueness of the solution; see Theorem 2.4.8. Despite of this drawback, on the one hand, it is not clear how to produce a-priori a symmetric solution (clearly, average does not work) and, on the other hand, the method we use works in a more general setting where, apparently, the non-compact uniqueness result of Theorem 2.4.10 is not applicable. See Remark 2.6.7.

### 2.6.1 A non-compact symmetry result: statement and comments

Let  $M_{\Psi} = (M, g^M, dv_{\Psi})$  be the  $m$ -dimensional weighted Riemannian manifold given as the warped product

$$M = I \times_{\sigma} N$$

where  $(N, g^N)$  is a possibly non-compact  $(m-1)$ -dimensional Riemannian manifold with  $\partial N = \emptyset$ ,  $I \subseteq \mathbb{R}$  is an interval,  $\sigma : I \rightarrow \mathbb{R}_{>0}$  is a smooth function and

$$\Psi(r, \xi) = \Phi(r) + \Gamma(\xi) \tag{2.6.1}$$

splits into the sum of two smooth functions depending respectively on the  $I$ -variable and on the  $N$ -variable. Consider the annulus  $\bar{A}(r_1, r_2) = [r_1, r_2] \times N$ . By the coarea formula, the volume of  $\bar{A}(r_1, r_2)$  has the expression

$$\text{vol}_{\Psi}(\bar{A}(r_1, r_2)) = \text{vol}_{\Gamma}(N) \int_{r_1}^{r_2} e^{-\Phi(r)} \sigma^{m-1}(r) dr.$$

Moreover, we note explicitly that

$$\Delta^M u = \partial_r^2 u + (m-1) \frac{\sigma'}{\sigma} \partial_r u + \frac{1}{\sigma^2} \Delta^N u$$

and thus

$$\begin{aligned} \Delta_\Psi^M u &= \partial_r^2 u + (m-1) \frac{\sigma'}{\sigma} \partial_r u + \frac{1}{\sigma^2} \Delta^N u - g(\nabla^M u, \nabla^M \Psi) \\ &= \partial_r^2 u + \left( (m-1) \frac{\sigma'}{\sigma} - \Phi' \right) \partial_r u + \frac{1}{\sigma^2} \Delta^N u - \sigma^2 g^N \left( \frac{\nabla^N u}{\sigma^2}, \frac{\nabla^N \Gamma}{\sigma^2} \right) \\ &= \partial_r^2 u + \left( (m-1) \frac{\sigma'}{\sigma} - \Phi' \right) \partial_r u + \frac{1}{\sigma^2} \Delta^N u - \frac{1}{\sigma^2} g^N(\nabla^N u, \nabla^N \Gamma) \\ &= \partial_r^2 u + \left( (m-1) \frac{\sigma'}{\sigma} - \Phi' \right) \partial_r u + \frac{1}{\sigma^2} \Delta_\Gamma^N u \end{aligned}$$

In particular,  $\bar{A}(r_1, r_2)$  is  $\Psi$ -isoparametric and we have the validity of the commutation rule

$$[\Delta_\Psi^M, \Delta_\Gamma^N] = 0. \quad (2.6.2)$$

We are now ready to state our non-compact symmetry result. Since the underlying manifold is always  $M_\Psi$  and there is no danger of confusion, from now on we shall omit the overscript  $M$  in the corresponding quantities and operators.

**Theorem 2.6.5.** *Let  $M_\Psi = (I \times_\sigma N)_\Psi$  where  $(N, g^N)$  is a complete (possibly non-compact), connected,  $(m-1)$ -dimensional Riemannian manifold with finite  $\Gamma$ -volume  $\text{vol}_\Gamma(N) < +\infty$ .*

*Let  $u \in C^4(\bar{A}(r_1, r_2))$  be a solution to the Dirichlet problem*

$$\begin{cases} \Delta_\Psi u = f(u) & \text{in } A(r_1, r_2) \\ u \equiv c_1 & \text{on } \{r_1\} \times N \\ u \equiv c_2 & \text{on } \{r_2\} \times N. \end{cases} \quad (2.6.3)$$

where  $c_j \in \mathbb{R}$  are given constants and  $f(t) \in C^2$  satisfies  $f''(t) \leq 0$ . If

$$\|u\|_{C_{rad}^2} := \sup_{A(r_1, r_2)} |u| + \sup_{A(r_1, r_2)} |\partial_r u| + \sup_{A(r_1, r_2)} |\partial_r^2 u| < +\infty, \quad (2.6.4)$$

and  $f'(u) \geq -B$ , for some constant  $B \geq 0$  satisfying

$$0 \leq B < \left( \int_{r_1}^{r_2} \frac{\int_{r_1}^s e^{-\Phi(z)} \sigma^{m-1}(z) \, dz}{e^{-\Phi(s)} \sigma^{m-1}(s)} \, ds \right)^{-1} \quad (2.6.5)$$

then  $u(r, \xi) = \hat{u}(r)$  is symmetric.

**Remark 2.6.6.** Under the additional assumption  $[\Delta_\Psi, \Delta_\Gamma^N](u) \leq 0$ , this symmetry result can be easily generalized to every smooth weight  $\Psi(r, \xi)$  satisfying the condition  $\partial_r \Psi \in L^\infty(A(r_1, r_2))$ . This is needed to ensure the existence of the function  $\varphi$  claimed in Theorem 2.6.13. Clearly, in this case condition (2.6.5) need to be slightly modified.



**Remark 2.6.7.** Some observations on the statement of Theorem 2.6.5 are in order.

a) Obviously, if  $N$  is compact, assumption (2.6.4) is automatically satisfied. In this case, if there exists at least one symmetric solution  $u$  of (2.6.7), then each solution must coincide with the symmetric one, thanks to the uniqueness result contained in Theorem 2.4.10. In the opposite direction, the symmetry result could be useful in establishing whether a symmetric solution actually exists. In fact, the concave non-linearity  $f(t)$  is so general that neither standard conditions for the coerciveness of the energy functional are automatically satisfied nor min-max and sub/super-solution methods can be applied directly to construct a symmetric, say one-dimensional, solution. See for instance [4] and [102].

b) In the non-compact case, the boundedness assumption (2.6.4) of Theorem 2.6.5 is skew with the  $W^{1,2}$  global regularity needed in Theorem 2.4.10. Thus, we do not know whether or not there is some global uniqueness of the (stable) solution.

c) Condition (2.6.5) is clearly satisfied if  $f'(u) \geq -B = 0$ . As a matter of fact, it will be clear from Lemma 2.6.13 that there is a (strong) stability condition hidden in (2.6.5). Indeed, the validity of (2.6.5) implies the existence of a smooth solution  $\varphi > 0$  of  $\mathcal{L}\varphi \leq 0$  on  $\text{int } M$ , where  $\mathcal{L} = \Delta_\Psi - f'(u)$  is the stability operator. According to a classical result independently due to Fischer-Colbrie and Schoen, [38], and to Moss and Piepenbrink, [75] (see also [30]), we have that  $\lambda_1^{-\mathcal{L}}(A(r_1, r_2)) \geq 0$ . But in fact more is true because we can even obtain that  $C^{-1} \leq \varphi \leq C$  on the whole  $\bar{A}(r_1, r_2)$ .

d) At the end of this section we will see how condition (2.6.5) can be replaced by the strong stability assumption on the function  $u$ , thanks to the validity of the Maximum Principle stated in Theorem 1.2.23. It is the content of Theorem 2.6.16.

e) It would be interesting to note that condition (2.6.5) can be written as

$$0 \leq \int_{r_1}^{r_2} \frac{\text{vol}_\Psi A(r_1, s)}{\text{area}_\Psi \Sigma_s} ds < \frac{1}{B}$$

where the integrand is the inverse of the Cheeger isoperimetric quotient.

f) From a different perspective, symmetry on Riemannian (warped) products have been previously investigated in [37] by A. Farina, L. Mari and E. Valdinoci. Their viewpoint is that of the De Giorgi conjecture where, a-priori, it is not known along which direction the stable solution to the Allen-Cahn type equation is symmetric. Thus, their result takes the form of a geometric splitting of the underlying space. See also [6] by M. Batista and I.J. Santos for the case of weighted manifolds and negative Ricci lower bounds.

As a concrete example where to set Theorem 2.6.5 in, we can consider the weighted slabs of Example 2.2.13, thus obtaining the following

**Corollary 2.6.8.** *Let  $\bar{A}(r_1, r_2) = [r_1, r_2] \times \mathbb{R}^{n-1} \subset \mathbb{G}^n = \mathbb{R}_\Psi^n$  be a slab in the Gaussian space, whose weight writes as  $\Psi(r, \xi) = \frac{r^2}{2} + \frac{|\xi|^2}{2}$ .*

*Let  $u \in C^4(\bar{A}(r_1, r_2))$  be a solution to the Dirichlet problem*

$$\begin{cases} \Delta_\Psi u = f(u) & \text{in } A(r_1, r_2) \\ u \equiv c_1 & \text{on } \{r_1\} \times N \\ u \equiv c_2 & \text{on } \{r_2\} \times N. \end{cases}$$

where  $c_j \in \mathbb{R}$  are given constants and  $f(t) \in C^2$  satisfies  $f''(t) \leq 0$ . If

$$\|u\|_{C_{rad}^2} < +\infty$$

and  $f'(u) \geq -B$ , for some constant  $B \geq 0$  satisfying

$$0 \leq B < \left( \int_{r_1}^{r_2} \frac{\int_{r_1}^s e^{-z^2/2} dz}{e^{-s^2/2}} ds \right)^{-1}$$

then  $u(r, \xi) = \hat{u}(r)$  is symmetric.

*Proof.* Thanks to the presence of the Gaussian weight, the leaves of the foliation have finite volume. Thus we can apply Theorem 2.6.5, obtaining the claim.  $\square$

Observe that this is not true for the same domains in Euclidean space: this fact points out how the presence of a weight that deforms the Riemannian measure may strongly influence the structure of solutions to the equation  $\Delta u = f(u)$ .

A second important consequence of Theorem 2.6.5 concerns weights with vanishing tangential component.

**Corollary 2.6.9.** *Let  $M_\Psi = (I \times_\sigma N)_\Psi$  where  $\Psi(r, \xi) = \hat{\Psi}(r)$  is a symmetric smooth function and  $(N, g^N)$  is a complete (possibly non-compact), connected,  $(m-1)$ -dimensional Riemannian manifold with finite volume  $\text{vol}(N) < +\infty$ .*

*Let  $u \in C^4(\bar{A}(r_1, r_2))$  be a solution to the Dirichlet problem*

$$\begin{cases} \Delta_\Psi u = f(u) & \text{in } A(r_1, r_2) \\ u \equiv c_1 & \text{on } \{r_1\} \times N \\ u \equiv c_2 & \text{on } \{r_2\} \times N. \end{cases}$$

where  $c_j \in \mathbb{R}$  are given constants and  $f(t) \in C^2$  satisfies  $f''(t) \leq 0$ . If

$$\|u\|_{C_{rad}^2} < +\infty$$

and  $f'(u) \geq -B$ , for some constant  $B \geq 0$  satisfying

$$0 \leq B < \left( \int_{r_1}^{r_2} \frac{\int_{r_1}^s e^{-\Psi(z)} \sigma^{m-1}(z) dz}{e^{-\Psi(s)} \sigma^{m-1}(s)} ds \right)^{-1}$$

then  $u(r, \xi) = \hat{u}(r)$  is symmetric.

## 2.6.2 Some preliminary lemmas

We have already mentioned that the notion of  $\mathcal{N}$ -parabolicity, introduced in Section 2.4.2, is a kind of compactness from many viewpoints. The following result contains further instances.

**Theorem 2.6.10.** *Let  $M_\Psi$  be a weighted Riemannian manifold with (possibly empty) boundary  $\partial M$ .*

- a) (Stokes theorem: general vector fields, [60]) *If  $M_\Psi$  is  $\mathcal{N}$ -parabolic then, given a vector field  $X$  satisfying  $|X| \in L^2(M, dv_\Psi)$ ,  $g(X, \vec{\nu}) \in L^1(\partial M, da_\Psi)$ ,  $\operatorname{div}_\Psi(X) \in L^1(M, dv_\Psi)$ , it holds*

$$\int_M \operatorname{div}_\Psi(X) \, dv_\Psi = \int_{\partial M} g(X, \vec{\nu}) \, da_\Psi.$$

- b) (Stokes theorem: gradient vector fields and no boundary, [45, Prop. 3.1]) *If  $M_\Psi$  is parabolic and  $\partial M = \emptyset$  then, given  $u \in W_{loc}^{1,2}(M, dv_\Psi)$  satisfying  $u \in L^\infty(M, dv_\Psi)$  and  $\Delta_\Psi u \in L^1(M, dv_\Psi)$ , it holds*

$$\int_M \Delta_\Psi u \, dv_\Psi = 0.$$

- c) (Volume growth, [42]) *Assume that  $M_\Psi$  is complete(!) and that  $\frac{R}{\operatorname{vol}_\Psi B_R(o)} \notin L^1(+\infty)$  for some (any)  $o \in \operatorname{int} M$ . Then  $M_\Psi$  is  $\mathcal{N}$ -parabolic.*

Keeping the notation and the assumptions of Theorem 2.6.5, the above potential theoretic tools enable us to deduce some useful preliminary properties of the  $\Psi$ -isoparametric domain  $\bar{A}(r_1, r_2)$  and of the solution  $u$ .

In view of the next Lemma, recall that  $N_\Gamma$  is complete weighted manifold with  $\partial N = \emptyset$  and  $\operatorname{vol}_\Gamma(N) < +\infty$ .

**Lemma 2.6.11.** *The following hold.*

- i)  $N_\Gamma$  is parabolic;  
ii) *The closed annulus  $\bar{A}(r_1, r_2)_\Psi$  endowed with the weight and the warped product metric inherited from  $M_\Psi$  is a weighted  $\mathcal{N}$ -parabolic manifold with  $\partial \bar{A}(r_1, r_2) \neq \emptyset$ .*

*Proof.* i) is a direct consequence of Theorem 2.6.10.c. Concerning ii), let  $\alpha = \min_{[r_1, r_2]} \sigma(r) > 0$  and  $\beta = \max_{[r_1, r_2]} \sigma(r) < +\infty$  so that, on  $\bar{A}(r_1, r_2)$ ,

$$dr \otimes dr + \alpha \cdot g^N \leq g \leq dr \otimes dr + \beta \cdot g^N$$

in the sense of quadratic forms. Since the LHS metric is complete and the RHS metric has finite  $\Psi$ -volume the conclusion follows again from Theorem 2.6.10.c.  $\square$

For the next Lemma recall also that  $\|u\|_{C_{rad}^2} < +\infty$ .

**Lemma 2.6.12.** *We have*

$$\Delta_\Gamma^N u \in L^\infty(A(r_1, r_2)).$$

*Moreover, for every fixed  $\bar{r} \in [r_1, r_2]$ ,*

$$\Delta_\Gamma^N u(\bar{r}, \cdot) \in L^1(N, dv_\Gamma)$$

*and*

$$\int_N \Delta_\Gamma^N u(\bar{r}, \xi) \, dv_\Gamma = 0.$$

*Proof.* Using the fact that  $\Delta_\Psi u = f(u)$  we can write

$$\Delta_\Gamma^N u = \sigma^2 f(u) - \sigma^2 \partial_r^2 u - \left( (m-1)\sigma\sigma' - \Phi'\sigma^2 \right) \partial_r u.$$

From this expression, since  $\sup_{[r_1, r_2]}(\sigma + |\sigma'| + |\Phi'|) < +\infty$ ,  $\|u\|_{C_{rad}^2} < +\infty$  and, hence,  $\sup_{A(r_1, r_2)} |f(u)| < +\infty$ , we get

$$\Delta_\Gamma^N u \in L^\infty(A(r_1, r_2)).$$

In particular, for every  $\bar{r} \in [r_1, r_2]$ ,

$$\Delta_\Gamma^N u(\bar{r}, \cdot) \in L^\infty(N).$$

Recalling that  $\text{vol}_\Gamma(N) < +\infty$  it follows that  $\Delta_\Gamma^N u(\bar{r}, \cdot) \in L^1(N, \text{dv}_\Gamma)$ . Since  $u(\bar{r}, \cdot) \in L^\infty(N)$  and  $N_\Gamma$  is parabolic without boundary, by Theorem 2.6.10.b we conclude that  $\int_N \Delta_\Gamma^N u(\bar{r}, \xi) \text{dv}_\Gamma(\xi) = 0$ , as required.  $\square$

The previous Lemmas, stemming from potential theoretic considerations, will play a fundamental role in the proof of Theorem 2.6.5. Besides them, we shall also need the validity of the non-compact maximum principle from Proposition 2.4.7. This follows from the next

**Lemma 2.6.13.** *There exists a function  $\varphi \in C^2(A(r_1, r_2)) \cap C^0(\bar{A}(r_1, r_2))$  satisfying condition (2.4.2) of Proposition 2.4.7, namely,*

$$\begin{cases} \mathcal{L}\varphi \leq 0 & A(r_1, r_2) \\ \frac{1}{C} \leq \varphi \leq C & \bar{A}(r_1, r_2), \end{cases}$$

where, as usual,  $\mathcal{L} = \Delta_\Psi - f'(u)$  is the stability operator.

*Proof.* Let us start by considering the differential inequality  $(\Delta_\Psi - f'(u))\varphi \leq 0$  when applied to a symmetric function  $\varphi(r, \xi) = \varphi(r)$ , that is,

$$\varphi'' + \left( (m-1)\frac{\sigma'}{\sigma} - \Phi' \right) \varphi' - f'(u) \leq 0 \quad \text{in } I = (r_1, r_2).$$

Since  $f'$  is continuous and  $u$  is bounded, then there exists  $B \geq 0$  such that

$$-f'(u) \leq B$$

obtaining

$$\varphi'' + \left( (m-1)\frac{\sigma'}{\sigma} - \Phi' \right) \varphi' - f'(u) \leq \varphi'' + \left( (m-1)\frac{\sigma'}{\sigma} - \Phi' \right) \varphi' + B.$$

Under condition (2.6.5), a function  $\varphi$  solving the above can be obtained by considering the solution to

$$\begin{cases} \varphi'' + \left( (m-1)\frac{\sigma'}{\sigma} - \Phi' \right) \varphi' + B = 0 & \text{in } I \\ \varphi(r_1) = 1 \\ \varphi'(r_1) = b < 0 \end{cases} \quad (2.6.6)$$

for a suitable choice of  $b \in \mathbb{R}$ . Indeed, letting

$$\begin{aligned} B(t) &= B \int_{r_1}^t e^{\Phi(s)} \sigma^{1-m}(s) \int_{r_1}^s e^{-\Phi(z)} \sigma^{m-1}(z) dz ds \geq 0 \\ A(t) &= b e^{-\Phi(r_1)} \sigma^{m-1}(r_1) \int_{r_1}^t e^{\Phi(s)} \sigma^{1-m}(s) ds \leq 0, \end{aligned}$$

if (2.6.5) is satisfied, then it is possible to choose  $b < 0$  such that

$$-1 < A(r_2) - B(r_2) < 0.$$

It follows that the function

$$\varphi(t) = 1 + A(t) - B(t)$$

is a positive and decreasing solution to (2.6.6). In particular,  $\varphi$  is bounded above by  $\varphi(r_1) = 1$ , so it clearly solves the differential inequality

$$\varphi'' + \left( (m-1) \frac{\sigma'}{\sigma} - \Phi' \right) \varphi' - f'(u) \varphi \leq \varphi'' + \left( (m-1) \frac{\sigma'}{\sigma} - \Phi' \right) \varphi' + B = 0.$$

The proof of the Lemma is completed.  $\square$

### 2.6.3 Proof of Theorem 2.6.5

Let us define

$$v(r, \xi) = \Delta_{\Gamma}^N u(r, \xi).$$

It is enough to show that, for every  $\bar{r} \in [r_1, r_2]$ ,

$$\xi \mapsto v(\bar{r}, \xi) \text{ is constant on } N.$$

Indeed, if this is the case, then  $u(\bar{r}, \cdot)$  is a bounded (sub / super) harmonic function on the parabolic weighted manifold  $N_{\Gamma}$ , therefore it must be constant on  $N$ . This is precisely what we have to prove.

Now, since  $u$  is (locally) constant on the boundary  $\partial A(r_1, r_2)$  then

$$v = 0 \quad \text{on } \partial A(r_1, r_2).$$

On the other hand, using the commutation rule (2.6.2), the fact that  $\Delta_{\Psi} u = f(u)$  and the properties of  $f$  we see that

$$\begin{aligned} \Delta_{\Psi} v &= \Delta_{\Gamma}^N f(u) \\ &= \Delta^N f(u) - g^N(\nabla^N f(u), \nabla^N \Gamma) \\ &= \operatorname{div}^N(\nabla^N f(u)) - f'(u) g^N(\nabla^N u, \nabla^N \Gamma) \\ &= \operatorname{div}^N(f'(u) \nabla^N u) - f'(u) g^N(\nabla^N u, \nabla^N \Gamma) \\ &= f''(u) |\nabla^N u|_N^2 + f'(u) \Delta^N u - f'(u) g^N(\nabla^N u, \nabla^N \Gamma) \\ &\leq f'(u) \Delta^N u - f'(u) g^N(\nabla^N u, \nabla^N \Gamma) \\ &= f'(u) v. \end{aligned}$$

Summarizing, the  $C^2$  function  $v$  solves

$$\begin{cases} \Delta_{\Psi}(-v) \geq f'(u)(-v) & \text{in } A(r_1, r_2) \\ (-v) = 0 & \text{on } \partial A(r_1, r_2). \end{cases}$$

By Lemma 2.6.13 we can apply the non-compact Protter-Weinberger maximum principle of Proposition 2.4.7, and we get

$$v \geq 0 \text{ in } A(r_1, r_2).$$

On the other hand,

$$\begin{aligned} \int_{A(r_1, r_2)} v \, dv_{\Psi} &= \int_{r_1}^{r_2} \left( \int_{\{t\} \times N} v(t, \xi) \, dv_{\Gamma}(\xi) \right) e^{-\Phi(t)} \sigma^{m-1}(t) dt \\ &= \int_{r_1}^{r_2} \left( \int_N \Delta_{\Gamma}^N u(t, \xi) \, dv_{\Gamma}(\xi) \right) e^{-\Phi(t)} \sigma^{m-1}(t) dt \\ &= 0 \end{aligned}$$

where, for the last equality, we have used Lemma 2.6.12. As a consequence,

$$v \equiv 0 \text{ on } A(r_1, r_2),$$

as required. The proof of the theorem is completed.

#### 2.6.4 Infinite annuli

Theorem 2.6.5 can be easily generalized to the case of infinite annuli, under suitable assumptions that are trivially satisfied in the case of finite annuli.

To this end, consider  $A(r_0, +\infty) = (r_0, +\infty) \times_{\sigma} N$  with  $r_0 \in \mathbb{R}_{>0}$  and suppose that  $\bar{A}(r_0, +\infty)$  is  $\mathcal{N}$ -parabolic. If the warping function  $\sigma$  is a bounded function with bounded derivative, then Lemma 2.6.12 extends trivially to this setting. Moreover, if the function

$$\theta : s \mapsto \frac{\int_{r_0}^s e^{-\Phi(z)} \sigma^{m-1}(z) \, dz}{e^{-\Phi(s)} \sigma^{m-1}(s)}$$

is integrable over  $(r_0, +\infty)$ , then the proof of Lemma 2.6.13 can be readapted, ensuring the existence of the function  $\varphi$  and allowing the non-compact Maximum Principle of Theorem 2.4.7 to hold.

In this way, the whole proof of Theorem 2.6.5 can be retraced step by step also in the context of infinite annuli, obtaining the next

**Theorem 2.6.14.** *Let  $M_{\Psi} = (\mathbb{R}_{\geq 0} \times_{\sigma} N)_{\Psi}$  where  $(N, g^N)$  is a complete (possibly non-compact), connected,  $(m-1)$ -dimensional Riemannian manifold with finite  $\Gamma$ -volume  $\text{vol}_{\Gamma}(N) < +\infty$  and  $\sigma \in L^{\infty}(\mathbb{R}_{\geq 0})$  satisfies  $\sigma' \in L^{\infty}(\mathbb{R}_{\geq 0})$ . Suppose also that  $\bar{A}(r_0, +\infty)$  is a  $\mathcal{N}$ -parabolic manifold.*

Let  $u \in C^4(\bar{A}(r_0, +\infty))$  be a solution to the Dirichlet problem

$$\begin{cases} \Delta_{\Psi} u = f(u) & \text{in } A(r_0, +\infty) \\ u \equiv c_0 & \text{on } \{r_0\} \times N. \end{cases} \quad (2.6.7)$$

where  $c_0 \in \mathbb{R}$  is a given constant and the function  $f(t)$  is of class  $C^2$  and satisfies  $f''(t) \leq 0$ . If

$$\|u\|_{C_{rad}^2} < +\infty \quad (2.6.8)$$

$$\Delta_{\Gamma}^N u \in L^1(N, dv_{\Gamma}) \quad (2.6.9)$$

$$\theta(s) = \frac{\int_{r_0}^s e^{-\Phi(z)} \sigma^{m-1}(z) dz}{e^{-\Phi(s)} \sigma^{m-1}(s)} \in L^1(r_0, +\infty) \quad (2.6.10)$$

and  $f'(u) \geq -B$ , for some constant  $B \geq 0$  satisfying

$$0 \leq B < \left( \int_{r_0}^{+\infty} \theta(s) ds \right)^{-1} \quad (2.6.11)$$

then  $u(r, \xi) = \hat{u}(r)$  is symmetric.

**Remark 2.6.15.** Note that, when specified to a model manifold,  $A(r_0, +\infty)$  is the exterior domain  $\mathbb{M}(\sigma) \setminus B_r(o)$ .

Theorem 2.6.14 paves the way for further interesting studies about infinite annuli, such as a deeper understanding of the link between the warping function  $\sigma$  and the weight function  $\Psi$ . Indeed, it is only in the context of annuli with infinite radius that we can really understand how the behaviour of  $\sigma$  at infinity plays a role when combined with that of  $\Psi$ .

Lastly, it could also be interesting to better understand the  $\mathcal{N}$ -parabolicity and its compatibility with the conditions just required for infinite annuli.

### 2.6.5 Generalization under the assumption of strong stability

As an application of Theorem 1.2.23, we can replace (2.6.5) with the (simpler) strong stability condition of  $u$ .

**Theorem 2.6.16.** Let  $M_{\Psi} = (I \times_{\sigma} N)_{\Psi}$  where  $(N, g^N)$  is a complete (possibly noncompact), connected,  $(n-1)$ -dimensional Riemannian manifold without boundary. Moreover, assume that  $N_{\Gamma}$  is  $\mathcal{N}$ -parabolic.

Let  $u \in C^4(\bar{A}(r_1, r_2))$  be a solution to the Dirichlet problem

$$\begin{cases} \Delta_{\Psi} u = f(u) & \text{in } A(r_1, r_2) \\ u \equiv c_1 & \text{on } \{r_1\} \times N \\ u \equiv c_2 & \text{on } \{r_2\} \times N \end{cases}$$

where  $c_j \in \mathbb{R}$  are given constants and  $f(t) \in C^2$  satisfies  $f''(t) \leq 0$ . If  $u$  is strongly stable and

$$\|u\|_{C_{rad}^2} = \sup_{A(r_1, r_2)} |u| + \sup_{A(r_1, r_2)} |\partial_r u| + \sup_{A(r_1, r_2)} |\partial_r^2 u| < +\infty,$$

then  $u(r, \xi) = \hat{u}(r)$  is symmetric.

*Proof of Theorem 2.6.16.* Let us consider the function

$$v(r, \xi) := \Delta_{\Gamma}^N u(r, \xi)$$

which vanishes on  $\partial A(r_1, r_2)$ . By a direct calculation we have  $[\Delta_{\Psi}^M, \Delta_{\Gamma}^N] = 0$ , that implies

$$\begin{aligned} \Delta_{\Psi}^M v &= \Delta_{\Gamma}^N f(u) \\ &= f''(u) |\nabla^N u|_N^2 + f'(u)v \\ &\leq f'(u)v. \end{aligned}$$

It follows that  $v$  satisfies

$$\begin{cases} \Delta_{\Psi}(-v) \geq f'(u)(-v) & \text{in } A(r_1, r_2) \\ -v = 0 & \text{on } \partial A(r_1, r_2) \end{cases}.$$

and, using the strong stability assumption on  $u$ , by Theorem 1.2.23 we get

$$v \geq 0 \text{ in } A(r_1, r_2). \quad (2.6.12)$$

On the other hand, thanks to the parabolicity of  $N_{\Gamma}$ , we can apply [45, Proposition 3.1] and Lemma 2.6.12 obtaining

$$\int_{A(r_1, r_2)} v \, dv_{\Psi} = \int_{r_1}^{r_2} \left( \int_{\{t\} \times N} \Delta_{\Gamma}^N u(t, \xi) \, dv_{\Gamma}(\xi) \right) e^{-\Phi(t)} \sigma^{m-1}(t) \, dt = 0$$

that, together with (2.6.12), implies  $v \equiv 0$  in  $A(r_1, r_2)$ .

It follows that for every fixed  $\bar{r} \in [r_1, r_2]$  the function  $\xi \mapsto v(\bar{r}, \xi)$  is constant on  $N$  and thus  $\xi \mapsto u(\bar{r}, \xi)$  is a bounded harmonic function on the  $\mathcal{N}$ -parabolic manifold  $N_{\Gamma}$ . By definition of  $\mathcal{N}$ -parabolicity, this implies that  $u(\bar{r}, \cdot)$  is constant in  $N_{\Gamma}$ , as claimed.  $\square$



## Part II

# Positivity preservation



---

## Introduction to Part II

---

The core of Part II is the study of the positivity preserving property for solutions to elliptic PDEs involving Schrödinger operators of the form  $-\Delta + \lambda$  that act on Riemannian manifolds.

In order to set our work, we first recall the notion of *differential inequality in the sense of distributions*. Let  $(M, g)$  be a Riemannian manifold and  $\lambda$  a measurable function over  $M$ . Given  $f \in L^1_{loc}(M)$ , we say that  $u \in L^1_{loc}(M)$  satisfies  $-\Delta u + \lambda u \geq f$  (respectively  $\leq f$ ) in the sense of distributions if

$$\int_M u(-\Delta\varphi + \lambda\varphi) \, dv \geq \int_M f\varphi \, dv \quad (\text{resp. } \leq)$$

for every  $0 \leq \varphi \in C^\infty_c(M)$ . Using an integration by parts, one can easily see that the notion of differential inequality in the sense of distributions is a generalization of the notion of weak differential inequality, which involves  $W^{1,1}$  functions. With the help of this definition we are able to introduce the main character of the following chapters.

**Definition II.A** (Positivity preserving property). *Given a Riemannian manifold  $(M, g)$  and a family of function  $\mathcal{S} \subseteq L^1_{loc}(M)$ , we say that  $M$  has the  $\mathcal{S}$  positivity preserving property for the operator  $-\Delta + \lambda$  if any function  $u \in \mathcal{S}$  that satisfies  $-\Delta u + \lambda u \geq 0$  in the sense of distributions is nonnegative almost everywhere in  $M$ .*

The notion of positivity preservation has been introduced by Güneysu [48] and, historically, it is motivated by the work of M. Braverman, O. Milatovic and M. Shubin. Indeed, in [22] the authors managed to prove that if  $\lambda$  is a nonnegative potential, then the self-adjointness of the Schrödinger operator  $-\Delta + \lambda$  is implied by the  $L^2$  positivity preserving property of the operator  $-\Delta + 1$ . On the other hand, it is a standard fact (see [100, 22, 52]) that also the geodesic completeness is a sufficient condition for the self-adjointness of this kind of operators. Because of this two facts, in [22] Braverman, Milatovic and Shbin conjectured that

**Conjecture II.B** (BMS). *If  $(M, g)$  is a geodesically complete Riemannian manifold, then the  $L^2$  positivity preserving property holds for the operator  $-\Delta + 1$ .*

Stimulated by this conjecture, in the subsequent years the relation between completeness and  $L^p$  positivity preservation for  $p \in [1, +\infty]$  has been widely studied. After some partial results involving constraints on the geometry of the manifold at hand, and covering all cases

$p \in [1, +\infty]$ , in [85] (see also [87] and [51]) S. Pigola, D. Valtorta and G. Veronelli proved that any Riemannian manifold  $(M, g)$  obtained by removing from a complete manifold  $(N, g)$  a “small” (compact) set  $K$  has the  $L^p$  positivity preserving for the operator  $-\Delta + 1$  for every  $p \in (1, +\infty)$ . We stress that without some “smallness” condition on  $K$  the  $L^p$  positivity preserving generally fails for every  $p \in [1, +\infty]$ . As an example we can consider the function  $u(x) = -|x|$  defined over the Euclidean open ball  $\mathbb{B}_1 \subset \mathbb{R}^2$ . Indeed, by definition  $u \leq 0$  while

$$(-\Delta + 1)u \leq 0 \quad \text{and} \quad u \in L^p(\mathbb{B}_1) \quad \forall p \in [1, +\infty].$$

**Chapter 3** In this framework, the third chapter of this thesis finds its aim. There we want to discuss and to clarify the  $L^p$  positivity preservation for  $-\Delta + 1$  in the cases  $p = 1$  and  $p = +\infty$ , closing, with the results obtained in [87, 85, 51], the picture of the situation.

For the case  $p = +\infty$ , one of the most general condition known so far is given by Marini and Veronelli in [70], where the authors proved that complete Riemannian manifolds whose Ricci curvature satisfies a certain (asymptotic) condition are  $L^\infty$  positivity preserving. On noting that the same condition assumed by Marini and Veronelli implies also the stochastic completeness of the manifold at hand (see [58]), this led us to better deepen the relationship between stochastic completeness and  $L^\infty$  positivity preservation, obtaining the following

**Theorem II.C.** *Let  $(M, g)$  be a (possibly incomplete) Riemannian manifold, then  $M$  has the  $L^\infty$  positivity preserving property for  $-\Delta + 1$  if and only if it is stochastically complete.*

The proof of Theorem II.C is the content of Section 3.1. The key ingredient to achieve this result is the following (local) approximation argument by smooth subharmonic functions, which is of independent interest. It is contained in Section 3.2.

**Theorem II.D.** *Let  $(M, g)$  be a Riemannian manifold and let  $u \in L^1_{loc}(M)$  be a solution to  $(\Delta - 1)u \geq 0$  in the sense of distributions. Then for every  $\Omega \Subset M$  there exists a sequence  $\{u_k\} \subset C^\infty(\Omega)$  such that:*

- (i)  $u_k \searrow u$  pointwise a.e.;
- (ii)  $(\Delta - 1)u_k \geq 0$  for all  $k$ ;
- (iii)  $u_k \rightarrow u$  in  $L^1(\Omega)$ ;
- (iv)  $\|u_k\|_{L^\infty(\Omega)} \leq 2\|u\|_{L^\infty(\Omega)}$  and, if  $u \geq 0$ ,  $\sup_{\Omega} u_k \leq 2 \operatorname{ess\,sup}_{\Omega} u$ .

For what concerns the case  $p = 1$ , the best result we know is the one of Marini and Veronelli, [70, Theorem II], which ensures the  $L^1$  positivity preserving property on complete manifolds with Ricci curvature satisfying  $\operatorname{Ric}(x) \geq -Cr^2(x)$  outside of a compact set. In fact, using a construction suggested by Veronelli, we also prove that the result of Theorem II in [70] alluded in the above is optimal. This fact is presented in Section 3.3.

**Theorem II.E.** *For every  $\varepsilon > 0$ , there exists a 2-dimensional Riemannian manifold  $(M, g)$  whose Gaussian curvature satisfies*

$$K(x) \sim -Cr(x)^{2+\varepsilon},$$

*such that the  $L^1$  positivity preserving property for  $-\Delta + 1$  fails on  $M$ .*

**Chapter 4** In Chapter 4 we consider a notion of positivity preserving property for slightly more general differential operators. In particular, we deal with Schrödinger operators of the form  $-\Delta + \lambda$ , where  $\lambda$  is a positive and locally bounded function.

In this context, in Section 4.2 we generalize the result of [87] (and [85]) in complete Riemannian manifolds, providing the  $\mathcal{S}_p$  positivity preservation for any  $p \in (1, +\infty)$ , where  $\mathcal{S}_p$  is the family of locally  $p$ -integrable functions satisfying a certain growth condition depending on  $p$  and on the decay rate of the potential  $\lambda$  at infinity. It is the content of

**Theorem II.F.** *Let  $(M, g)$  be a complete Riemannian manifold,  $\lambda \in L_{loc}^\infty(M)$  a positive function and  $p \in (1, +\infty)$ . Moreover, assume there exist  $o \in M$  and a constant  $C > 0$  so that*

$$\lambda(x) \geq \frac{C}{(1 + d^M(x, o))^{2-\varepsilon}} \quad \forall x \in M,$$

*where  $\varepsilon \in (0, 2]$  and  $d^M$  is the intrinsic distance on  $M$ .*

*If  $u \in L_{loc}^p(M)$  satisfies  $-\Delta u + \lambda u \geq 0$  in the sense of distributions and*

$$\int_{B_R(o)} (u^-)^p \, dv = o\left(e^{\theta R^{\frac{\varepsilon}{2}}}\right) \quad \text{as } R \rightarrow +\infty,$$

*where  $\theta = \sqrt{\frac{(p-1)C}{e-1}}$ , then  $u \geq 0$ .*

A crucial role for this result will be played by a refinement of the regularity result for complete manifolds contained in [87] and by an elementary iterative lemma, both presented in Section 4.1.

To follow, in Section 4.3 we provide two theorems concerning  $p = 1$ , in the case of  $\lambda$  positive constant. For the first result, under the assumption that there exists a family of exhausting cut-off functions whose Laplacians decay to zero at infinity, we get the positivity preservation on the class of  $L_{loc}^p$  functions whose negative part has an integral that grows at most polynomially.

**Theorem II.G.** *Let  $(M, g)$  be a complete Riemannian manifold and  $\lambda$  a positive constant. Assume that for a fixed  $o \in M$  there exist some positive constants  $\gamma$  and  $R_0$  and a constant  $\sigma > 1$  satisfying the following condition: for every  $R > R_0$  there exists  $\phi_R \in C_c^2(M)$  such that*

$$\begin{cases} 0 \leq \phi_R \leq 1 & \text{in } M \\ \phi_R \equiv 1 & \text{in } B_R(o) \\ \text{supp}(\phi_R) \subset B_{\sigma R}(o) & \\ |\Delta \phi_R| \leq \frac{C}{R^\gamma} & \text{in } M \end{cases}$$

where  $C = C(\sigma) > 0$  is a constant not depending on  $R$ . If  $u \in L^1_{loc}(M)$  satisfies  $-\Delta u + \lambda u \geq 0$  in the sense of distributions and there exists  $k \in \mathbb{N}$  so that

$$\int_{B_R(o)} u^- \, dv = O(R^k) \quad \text{as } R \rightarrow +\infty,$$

then  $u \geq 0$  almost everywhere in  $M$ .

Using a similar approach, in the second result we get the  $L^1_{loc}$  positivity preserving property just requiring that the family of cut-offs has equibounded Laplacians  $|\Delta \phi_R| \leq C$ . This assumption, weaker than the one considered in Theorem II.G, allows us to deal only with a smaller class of  $L^1_{loc}$  distributional supersolutions.

**Theorem II.H.** *Let  $(M, g)$  be a complete Riemannian manifold and  $\lambda$  a positive constant. Assume that for a fixed  $o \in M$  there exist some positive constants  $C$  and  $R_0$  and a constant  $\sigma > 1$  satisfying the following condition: for every  $R > R_0$  there exists  $\phi_R \in C^2_c(M)$  such that*

$$\begin{cases} 0 \leq \phi_R \leq 1 & \text{in } M \\ \phi_R \equiv 1 & \text{in } B_R(o) \\ \text{supp}(\phi_R) \subset B_{\sigma R}(o) & \\ |\Delta \phi_R| \leq C & \text{in } M. \end{cases}$$

If  $u \in L^1_{loc}(M)$  satisfies  $-\Delta u + \lambda u \geq 0$  in the sense of distributions and

$$\int_{B_R(o)} u^- \, dv = o(R^\theta) \quad \text{as } R \rightarrow +\infty$$

with  $\theta = \frac{\ln(1+\frac{\lambda}{C})}{\ln(\sigma)}$ , then  $u \geq 0$  almost everywhere in  $M$ .

To conclude, as an application of Theorem II.F, in Section 4.4 we prove that complete minimal submanifolds enjoy the following  $L^p$  extrinsic distance growth condition.

**Corollary II.I.** *Let  $x : \Sigma \hookrightarrow \mathbb{R}^m$  be a complete minimal submanifold and suppose there exists a positive function  $\xi : \mathbb{R}_{\geq 0} \rightarrow \mathbb{R}_{> 0}$  such that*

$$(d^{\mathbb{R}^m}(x, o))^2 \leq \xi(d^\Sigma(x, o)) \quad \text{and} \quad \xi(R) = O(R^{2-\epsilon}), \text{ as } R \rightarrow +\infty$$

for some constants  $C > 0$  and  $\epsilon \in (0, 2]$  and for some fixed origin  $o \in \Sigma$ . Then, for every  $p \in (1, +\infty)$ ,

$$\limsup_{R \rightarrow +\infty} \frac{\int_{B_R^\Sigma(o)} \xi^p \, dv_\Sigma}{e^{\theta R^{\frac{\epsilon}{2}}}} > 0,$$

where  $\theta = \sqrt{\frac{(p-1)C}{e-1}}$ .

**Chapter 5** To close the picture, in Chapter 5 we prove the  $L^p$  preservation of positivity for more general Schrödinger type operators acting on possibly incomplete Riemannian manifolds. As a by-product, we establish the essential self-adjointness (and its generalization to the case  $p \neq 2$ ) of such operators.

The strategy used in this chapter is based on the ones adopted in Chapter 4 and in [85]. In particular, with the help of the above mentioned refined regularity result (i.e. Proposition 4.1.2), in Section 5.1 we are able to prove the following  $L^p$  positivity preservation on incomplete Riemannian manifolds obtained by cutting off a compact subset (with controlled Minkowski content) from a complete manifold.

**Theorem II.J.** *Let  $(N, h)$  be a complete Riemannian manifold and define  $M := N \setminus K$ , where  $K \subset N$  is a compact subset. Consider  $V \in L_{loc}^\infty(M)$  so that*

$$V(x) \geq \frac{C}{r^m(x)} \quad \text{in } M,$$

where  $C \in [0, 1]$  and  $m \in \{0, 2\}$  are positive constants and  $r(x) := d^N(x, K)$  is the distance function from  $K$ . Fix  $p \in (1, +\infty)$ .

If there exist two positive constants  $E \geq 1$  and

$$h \geq \begin{cases} 0 & \text{if } m = 2 \text{ and } C = \frac{1}{p-1} \\ \frac{p+p\sqrt{1-(p-1)C}}{p-1} & \text{if } m = 2 \text{ and } C \in \left(0, \frac{1}{p-1}\right) \\ \frac{2p}{p-1} & \text{if } m = 0 \end{cases}$$

so that

$$|B_r(K)| \leq Er^h \quad \text{as } r \rightarrow 0,$$

then  $M$  has the  $L^p$  positivity preserving property for the differential operator  $-\Delta + V$ .

As highlighted at the beginning of this section, the positivity preserving property is strictly related to (and in fact arise from) the notion of self-adjointness of Schrödinger-type operators. In Section 5.2, a direct application of Theorem II.J lets us to recover the essential self-adjointness of the operator  $-\Delta + V$  on the manifold  $M := N \setminus K$ .

**Theorem II.K.** *Let  $(N, h)$  be a complete Riemannian manifold and define  $M := N \setminus K$ , where  $K \subset N$  is a compact subset. Consider  $V \in L_{loc}^\infty(M)$  so that*

$$V(x) \geq \frac{C}{r^m(x)} - B \quad \text{in } M,$$

where  $C \in [0, 1]$ ,  $m \in \{0, 2\}$  and  $B$  are positive constants and  $r(x) := d^N(x, K)$  is the distance function from  $K$ .

If there exist two positive constants  $E \geq 1$  and

$$h \geq \begin{cases} 0 & \text{if } m = 2 \text{ and } C = 1 \\ 2 + 2\sqrt{1-C} & \text{if } m = 2 \text{ and } C \in (0, 1) \\ 4 & \text{if } m = 0 \end{cases}$$

so that

$$|B_r(K)| \leq Er^h \quad \text{as } r \rightarrow 0,$$

then the differential operator  $-\Delta + V : C_c^\infty(M) \subset L^2 \rightarrow L^2$  is essentially self-adjoint.

In Section 5.3 we will see that the essential self-adjointness of a (unbounded) linear operator acting on an Hilbert space can equivalently be formulated in term of the notion of *operator core*. Using this equivalent definition, one is able to generalize the essential self-adjointness to the case of operators acting on Banach spaces. This fact motivated us to also investigate this property for Schrödinger operators acting on  $L^p(M)$  when  $p \neq 2$ . This is the content of the next theorem, that is proved in Section 5.3.

**Theorem II.L.** *Let  $(N, h)$  be a complete Riemannian manifold and define  $M := N \setminus K$ , where  $K \subset N$  is a compact subset. Consider  $V \in L_{loc}^\infty(M)$  so that*

$$V(x) \geq \frac{C}{r^m(x)} - B \quad \text{in } M,$$

where  $C \in [0, 1]$ ,  $B$  and  $m \in \{0, 2\}$  are positive constants and  $r(x) := d^N(x, K)$  is the distance function from  $K$ , and fix  $p \in (1, +\infty)$ .

If there exist two positive constants  $E \geq 1$  and

$$h \geq \begin{cases} 0 & \text{if } m = 2 \text{ and } C = \frac{1}{p-1} \\ p + p\sqrt{1 - \frac{C}{p-1}} & \text{if } m = 2 \text{ and } C \in \left(0, \frac{1}{p-1}\right) \\ 2p & \text{if } m = 0 \end{cases} \quad \text{in case } p \geq 2$$

or

$$h \geq \begin{cases} 0 & \text{if } m = 2 \text{ and } C = p - 1 \\ \frac{p+p\sqrt{1-(p-1)C}}{p-1} & \text{if } m = 2 \text{ and } C \in (0, p-1) \\ \frac{2p}{p-1} & \text{if } m = 0 \end{cases} \quad \text{in case } p < 2$$

so that

$$|B_r(K)| \leq Er^h \quad \text{as } r \rightarrow 0,$$

then  $C_c^\infty(M)$  is an operator core for  $(-\Delta + V)_{p, \max}$ .

We stress that in Theorem II.L we are requiring the Minkowski condition for  $p$  and  $p' = \frac{p}{p-1}$  in order to get both the  $L^p$  and  $L^{p'}$  positivity preservation from Theorem II.J. This is due to the fact that the property of  $C_c^\infty(M)$  to be an operator core for  $-\Delta + V$  acting on  $L^p(M)$  is (in a certain sense) equivalent to the validity of the same property for the dual space  $(L^p)^* = L^{p'}$ .



---

## $L^p$ Positivity preservation: $p = 1$ and $p = +\infty$ <sup>1</sup>

---

Throughout the current chapter, whenever we mention the  $L^p$  positivity preserving property, we will be implicitly referring to the differential operator  $-\Delta + 1$ .

### 3.1 $L^\infty$ positivity preserving property and stochastic completeness

In recent years there has been an effort to better understand the  $L^p$  positivity preserving property and to find geometric and analytic conditions that ensure its validity. If we consider  $M = \mathbb{R}^n$  with the usual Euclidean metric, the  $L^2$  positivity preserving property was first proved by Kato, [64], using the theory of operators on tempered distributions. However, in a Riemannian setting, tempered distributions are not readily available, so alternative approaches are necessary.

Following an idea of Davies in [22], if the manifold admits a family of smooth cutoff functions with good control on the Laplacian, it is possible to prove the  $L^p$  positivity preserving property. In this direction, notable results have been obtained by Braverman, Milatovic, and Schubin in [22]; by Güneysu in [47, 49]; by Bianchi and Setti in [14]; and by Marini and Veronelli in [70].

However, the original BMS conjecture has remained open for 20 years and has only recently been solved positively in [85] (also see [87, 51]), where the authors managed to prove that every geodesically complete Riemannian manifold satisfies the  $L^p$  positivity preservation for any  $p \in (1, +\infty)$ . The proof of this fact is based on the validity of an  $L^p$  Liouville property that, together with some new regularity results for nonnegative subharmonic distributions, implies the  $L^p$  positivity preserving property. While this  $L^p$  Liouville theorem is known to hold on complete Riemannian manifolds for every  $p \in (1, +\infty)$  (see [105]), there are several counterexamples to this property for  $p = 1$  or  $p = +\infty$ .

---

<sup>1</sup>The content of this chapter is based on [18], a joint work with Dr. Ludovico Marini.

The case  $p = +\infty$  is instead related to the notion of stochastic completeness. Recall that a manifold is said to be stochastically complete if the Brownian paths on  $M$  have almost surely infinite lifetime or, equivalently, if the minimal positive heat kernel associated to the Laplace-Beltrami operator preserves probability. For the scope of this chapter, however, we shall adopt the following (equivalent) definition, which is more relevant from the point of view of PDEs.

**Definition 3.1.1** (Stochastic completeness). *A Riemannian manifold  $(M, g)$  is said to be stochastically complete if the only bounded, nonnegative  $C^2$  solution to  $\Delta u \geq u$  on  $M$  is  $u \equiv 0$ .*

There are countless characterizations of stochastic completeness, a comprehensive account is beyond the scope of this thesis, we refer the reader to [42, 44, 81, 83] or the very recent [46]. Stochastic completeness is implied by several geometric, analytic and probabilistic conditions. For instance, stochastic completeness is ensured by conditions on the curvature tensor. In this direction, the most general result is the one of Hsu in [58], a particular case of which states that geodesically complete manifold whose Ricci curvature satisfies

$$\text{Ric}(x) \geq -Cr^2(x)$$

outside a compact set are in fact stochastically complete.

As a matter of fact, the  $L^\infty$  positivity preserving property implies stochastic completeness of the manifold at hand, as it has been observed by Güneysu in [47]. In particular, stochastically incomplete manifolds provide counterexamples to the validity of the  $L^\infty$  positivity preserving property. As an example, take a Cartan–Hadamard manifold whose Ricci curvature diverges at  $-\infty$  faster than quadratically, for computations we refer to [70].

**Remark 3.1.2.** To the best of our knowledge, the most general condition known so far ensuring the validity of the  $L^\infty$  positivity preserving property is the one of Theorem II in [70]. This condition, which requires geodesic completeness and

$$\text{Ric}(x) \geq -Cr^2(x) \quad \text{outside a compact set,} \quad (3.1.1)$$

is essentially the celebrated condition of Hsu, [58], for stochastic completeness.

The above observations on the relation between the stochastic completeness and the  $L^\infty$  positivity preservation suggest a much closer relation between these two notions. The main result of this chapter is in fact the following

**Theorem 3.1.3.** *Let  $(M, g)$  be a (possibly incomplete) Riemannian manifold, then  $M$  has the  $L^\infty$  positivity preserving property if and only if it is stochastically complete.*

As pointed out in the introduction, there are several possible definitions one can give for stochastic completeness. We cite here the ones relevant to our exposition.

- (i) for every  $\lambda > 0$ , the only bounded, nonnegative  $C^2$  solution to  $\Delta u \geq \lambda u$  is  $u \equiv 0$ ;
- (ii) for every  $\lambda > 0$ , the only bounded, nonnegative  $C^2$  solution to  $\Delta u = \lambda u$  is  $u \equiv 0$ ;

(iii) the only bounded, nonnegative  $C^2$  solution to  $\Delta u = u$  is  $u \equiv 0$ .

For a proof of the equivalence we refer to Theorem 6.2 in [42].

**Remark 3.1.4.** Note that the regularity required in the above and in Definition 3.1.1 can be relaxed to  $C^0(M) \cap W_{loc}^{1,2}(M)$ ; see for instance Section 2 of [2]. This fact is a consequence of a stronger version of Theorem 3.1.11 below.

We begin with the following observation due to Güneysu, [47].

**Proposition 3.1.5.** *If  $(M, g)$  has the  $L^\infty$  positivity preserving property, then it is stochastically complete.*

*Proof.* To see this, take  $u \in C^2(M)$  a bounded and nonnegative function satisfying  $\Delta u \geq u$ . Then, if we set  $v = -u$  we have

$$v \in L^\infty(M) \quad (-\Delta + 1)v \geq 0.$$

By the  $L^\infty$  positivity preserving property, we conclude that  $v \geq 0$ . Since  $u$  is nonnegative, this yields  $v \equiv 0$  and hence  $u \equiv 0$ .  $\square$

**Remark 3.1.6.** It is worthwhile noticing that stochastic completeness is in general unrelated to geodesic completeness. It is possible to find Riemannian manifolds which are geodesically but not stochastically complete such as Cartan-Hadamard manifolds whose Ricci curvature diverges at  $-\infty$  faster than quadratically. On the other hand,  $\mathbb{R}^n \setminus \{0\}$  endowed with the Euclidean metric is stochastically complete but geodesically incomplete.

This fact, together with Proposition 3.1.5, explain the failure of the result of Pigola, Valtorta and Veronelli, [85], in the case  $p = +\infty$ .

In order to prove that stochastic completeness implies the  $L^\infty$  positivity preserving property, we show that it is essentially a problem of regularity for the distributional,  $L^\infty$  solutions to  $\mathcal{L}u \geq 0$ , where

$$\mathcal{L} = \Delta - 1.$$

In particular, a central role is played by the following monotone approximation theorem for the distributional solutions to  $\mathcal{L}u \geq 0$ , which is of independent interest. Its proof is presented in Section 3.2.

**Theorem 3.1.7.** *Let  $(M, g)$  be a Riemannian manifold and let  $u \in L_{loc}^1(M)$  be a solution to  $\mathcal{L}u \geq 0$  in the sense of distributions. Then for every  $\Omega \Subset M$  there exists a sequence  $\{u_k\} \subset C^\infty(\Omega)$  such that:*

- (i)  $u_k \searrow u$  pointwise a.e.;
- (ii)  $\mathcal{L}u_k \geq 0$  for all  $k$ ;
- (iii)  $u_k \rightarrow u$  in  $L^1(\Omega)$ ;
- (iv)  $\|u_k\|_{L^\infty(\Omega)} \leq 2 \|u\|_{L^\infty(\Omega)}$  and, if  $u \geq 0$ ,  $\sup_{\Omega} u_k \leq 2 \operatorname{ess\,sup}_{\Omega} u$ .

Using a trick due to Protter and Weinberger, [89], it is sufficient to prove a monotone approximation result for the distributional solution to  $\Delta_\alpha v \geq 0$ , where  $\Delta_\alpha v := \alpha^{-2} \operatorname{div}(\alpha^2 \nabla v)$  and  $\alpha$  is a smooth positive function to be specified later. The monotone approximation for the weighted Laplacian is obtained using a strategy outlined by Bonfiglioli and Lanconelli in [21] together with some mean value representation formulas for the solution to  $\Delta_\alpha v = 0$ . Theorem 3.1.7 generalizes a result of Pigola and Veronelli in [87] where the monotone approximation was proved only on coordinate charts.

**Remark 3.1.8.** If the manifold at hand admits a minimal, positive Green function for the operator  $\Delta_\alpha$  (i.e. it is  $\alpha$ -non-parabolic) and if this Green function vanishes at infinity (i.e. it is strongly  $\alpha$ -non-parabolic), as a byproduct of the proof of Theorem 3.1.7 we obtain a global, monotone approximation result.

### 3.1.1 From stochastic completeness to the $L^\infty$ positivity preserving property

The goal of this section is to set the ground towards proving the converse of Proposition 3.1.5.

To this end, let  $(M, g)$  be a stochastically complete Riemannian manifold and take  $u \in L^\infty(M)$  satisfying  $-\mathcal{L}u \geq 0$  in the sense of distributions. Our purpose is to show that  $u$  is nonnegative almost everywhere or, equivalently, that the negative part  $u_- = \max\{0, -u\} = (-u)_+$  vanishes a.e. The next ingredient in our proof is the following Brezis-Kato inequality due to Pigola and Veronelli, [87, Proposition 4.1]

**Theorem 3.1.9** (Brezis-Kato). *Given a Riemannian manifold  $(M, g)$ , if  $f \in L^1_{loc}(M)$  satisfies  $\mathcal{L}f \geq 0$  in the sense of distributions, then  $f_+ \in L^1_{loc}(M)$  and  $\mathcal{L}f_+ \geq 0$  in the sense of distributions.*

Since  $\mathcal{L}(-u) \geq 0$  we conclude that  $\mathcal{L}u_- \geq 0$  in the sense of distributions. If  $u_-$  was a  $C^2(M)$  function, stochastic completeness (see (i) at the beginning of Section 3.1) would allow us to conclude that  $u_- \equiv 0$ , hence  $u \geq 0$ . Note that, according to Remark 3.1.4,  $u_- \in C^0(M) \cap W^{1,2}_{loc}(M)$  would be sufficient. In general, however, this is not the case and, as a matter of fact, it is a stronger requirement than what we actually need. Indeed, if we find  $w \in C^2(M)$  such that  $\sup_M w < +\infty$ ,  $0 \leq u_- \leq w$  and  $\mathcal{L}w \geq 0$ , then stochastic completeness applied to  $w$  implies that  $w$  hence  $u_-$  are identically zero.

The existence of such function  $w$  is implied by the following corollary of Theorem 3.1.7, whose proof is postponed to the next section.

**Corollary 3.1.10.** *Let  $(M, g)$  be a Riemannian manifold and let  $u \in L^\infty(M)$  be a distributional solution to  $\mathcal{L}u \geq 0$ . Then, for every relatively compact  $\Omega \Subset M$  there exists some  $u_\Omega \in C^\infty(\Omega)$  which solves  $\mathcal{L}u_\Omega \geq 0$  in a strong sense and such that  $u \leq u_\Omega$  and  $\|u_\Omega\|_{L^\infty(\Omega)} \leq 2\|u\|_{L^\infty(\Omega)}$ .*

Via a compactness argument we use the functions  $u_\Omega$  to construct the function  $w$ . The following theorem, proved by Sattinger in [96], also comes into aid as it allows to obtain  $\mathcal{L}$ -harmonic function from super/sub solutions to  $\mathcal{L}u = 0$ .

**Theorem 3.1.11.** *Let  $u_1, u_2 \in C^\infty(M)$  satisfy*

$$\mathcal{L}u_1 \geq 0, \quad \mathcal{L}u_2 \leq 0, \quad u_1 \leq u_2$$

*on  $M$ . Then, there exists some  $w \in C^\infty(M)$  such that*

$$u_1 \leq w \leq u_2 \quad \text{and} \quad \mathcal{L}w = 0.$$

**Remark 3.1.12.** Theorem 3.1.11 is a weaker formulation of a much more general theorem, proved by Ratto, Rigoli and Véron, [92], for a wider class of functions, namely  $u_1, u_2 \in C^0(M) \cap W_{\text{loc}}^{1,2}(M)$ . This result goes under the name of sub and supersolution method or monotone iteration scheme. Note that the results of [92] hold for a larger class of second order elliptic operators. For a survey on the subject, we refer to Heikkilä and Lakshmikantham, [56].

Using the functions constructed locally in Corollary 3.1.10 together with an exhaustion procedure we obtain the following

**Theorem 3.1.13.** *Let  $(M, g)$  be a Riemannian manifold and let  $u \in L^\infty(M)$  satisfy  $\mathcal{L}u \geq 0$  in the sense of distributions. Then, there exists  $w \in C^\infty(M)$  such that  $u \leq w$ ,  $\mathcal{L}w \geq 0$  in a strong sense and  $\sup_M w < +\infty$ .*

*Proof.* We begin by observing that if  $u \in L^\infty(M)$  then, setting  $c = \|u\|_{L^\infty(M)}$ , we have

$$\mathcal{L}c = -c \leq 0 \text{ on } M.$$

Next, take  $\{\Omega_h\}$  an exhaustion of  $M$  by relatively compact sets such that

$$\Omega_1 \Subset \Omega_2 \Subset \dots \Subset \Omega_h \Subset \Omega_{h+1} \Subset \dots \Subset M,$$

$\partial\Omega_h$  is smooth and  $M = \cup_h \Omega_h$ . On each set  $\Omega_h$  we apply Corollary 3.1.10 and we obtain a sequence of functions  $u_h \in C^\infty(\Omega_h)$  such that

1.  $u \leq u_h$  in  $\Omega_h$ ;
2.  $\mathcal{L}u_h \geq 0$  strongly on  $\Omega_h$ ;
3.  $\|u_h\|_{L^\infty(\Omega_h)} \leq 2c$ .

Since  $\mathcal{L}(2c) \leq 0$ , we use Theorem 3.1.11 on each  $\Omega_h$  to obtain  $w_h \in C^\infty(\Omega_h)$  satisfying

1.  $\mathcal{L}w_h = 0$ ;
2.  $u_h \leq w_h$ ;
3.  $\|w_h\|_{L^\infty(\Omega_h)} \leq 2c$ .

We conclude by showing that  $\{w_h\}_h$  is bounded respect to the  $C^\infty(M)$ -topology and thus converges, up to a subsequence, to some  $w \in C^\infty(M)$ .

To this end, let  $K \subseteq V \subset M$  be a compact subset of a relatively compact open set  $V$  and  $k \in \mathbb{N}$ ,  $k \geq 2$ . By Schauder estimates for the operator  $\mathcal{L}$  we have

$$\|w_h\|_{C^k(K)} \leq A \left( \|w_h\|_{L^\infty(V)} + \|\mathcal{L}w_h\|_{C^{k-2,\alpha}(V)} \right)$$

for some  $\alpha \in (0, 1)$  and for  $h$  large enough so that  $V \subseteq \Omega_h$ . See for instance Section 6.1 of [41]. In particular there exists a constant  $C = C(K, n, k) > 0$  such that  $\|w_h\|_{C^k(K)} < C$  for every  $h \in \mathbb{N}$ . Here

$$\|w_h\|_{C^k(K)} = \|w_h\|_{L^\infty(K)} + \|\nabla w_h\|_{L^\infty(K)} + \cdots + \|\nabla^k w_h\|_{L^\infty(K)}.$$

Since  $\{w_h\}_h$  is pre-compact, it converges in the  $C^\infty(M)$  topology up to a subsequence, denoted again with  $\{w_h\}_h$ . Let  $w \in C^\infty(M)$  be the  $C^\infty$  limit, we have that

$$u \leq w, \quad \sup_M w < +\infty \quad \text{and} \quad \mathcal{L}w = 0.$$

□

This concludes the proof of Theorem 3.1.3, apart from the proof of Corollary 3.1.10.

## 3.2 Monotone approximation results

This section is devoted to the proof of Theorem 3.1.7. Instead of proving Theorem 3.1.7 directly, we prove an equivalent monotone approximation result for another elliptic differential operator closely related to  $\mathcal{L}$ . We begin by taking a function  $\alpha \in C^\infty(M)$  satisfying

$$\begin{cases} \mathcal{L}\alpha = 0 \\ \alpha > 0. \end{cases} \quad (3.2.1)$$

The existence of such function is ensured by [38], and is equivalent to the fact that  $\lambda_1^{-\mathcal{L}}(D) \geq 0$  for any bounded domain  $D \subseteq M$ , where  $\lambda_1^{-\mathcal{L}}(D)$  denotes the first Dirichlet eigenvalue of  $-\mathcal{L}$  on  $D$ . In our case, it is easy to see that  $\lambda_1^{-\mathcal{L}}(D) \geq 1$  over any bounded domain  $D \subseteq M$ .

Using  $\alpha$  we define the following drifted Laplacian

$$\Delta_\alpha : u \mapsto \alpha^{-2} \operatorname{div}(\alpha^2 \nabla u). \quad (3.2.2)$$

With a trivial density argument, one has that  $\Delta_\alpha$  is symmetric in  $L^2$  with respect to the measure  $\alpha^2 \operatorname{dv}_g$ . Then, using the following idea due to Protter and Weinberger, [89], we establish the relation between  $\Delta_\alpha$  and  $\mathcal{L}$ . See also Lemma 2.3 of [87].

**Lemma 3.2.1.** *If  $u \in L^1(\Omega)$  with  $\Omega \Subset M$ , then*

$$(\Delta - 1)u \geq 0 \quad \Leftrightarrow \quad \Delta_\alpha \left( \frac{u}{\alpha} \right) \geq 0,$$

where both inequalities are intended in the sense of distributions.

*Proof.* Fix  $0 \leq \varphi \in C_c^\infty(\Omega)$ , by direct computation we have

$$\begin{aligned} \alpha \Delta_\alpha \left( \frac{\varphi}{\alpha} \right) &= \alpha^{-1} \operatorname{div} \left[ \alpha^2 \nabla \left( \frac{\varphi}{\alpha} \right) \right] \\ &= \alpha^{-1} \operatorname{div} (\alpha \nabla \varphi - \varphi \nabla \alpha) \\ &= \Delta \varphi - \varphi \frac{\Delta \alpha}{\alpha} \\ &= \mathcal{L} \varphi, \end{aligned} \tag{3.2.3}$$

where in the last equation we have used (3.2.1). Thus, using (3.2.3) and the symmetry of  $\Delta_\alpha$  we conclude

$$\begin{aligned} \left( \Delta_\alpha \left( \frac{u}{\alpha} \right), \alpha \varphi \right)_{L^2} &= \int_\Omega \frac{u}{\alpha} \Delta_\alpha \left( \frac{\varphi}{\alpha} \right) \alpha^2 \, dv_g \\ &= \int_\Omega u (\Delta - 1) \varphi \, dv_g = ((\Delta - 1)u, \varphi)_{L^2}. \end{aligned}$$

□

Using Lemma 3.2.3 and setting  $v = \alpha^{-1}u$ , it is possible to obtain Theorem 3.1.7 from an equivalent statement for the operator  $\Delta_\alpha$ . In this perspective, our goal is to prove the following:

**Theorem 3.2.2.** *Let  $(M, g)$  be a Riemannian manifold and let  $v \in L^1_{loc}(M)$  be a solution to  $\Delta_\alpha v \geq 0$  in the sense of distributions. Then, for every  $\Omega \Subset M$  there exists a sequence  $\{v_k\} \subset C^\infty(\Omega)$  such that:*

- (i)  $v_k \searrow v$  pointwise a.e.;
- (ii)  $\Delta_\alpha v_k \geq 0$  for all  $k$ ;
- (iii)  $v_k \rightarrow v$  in  $L^1(\Omega)$ ;
- (iv)  $\sup_\Omega v_k \leq \operatorname{ess\,sup}_\Omega v$ .

### 3.2.1 Representation formula for $\alpha$ -harmonic functions

Let  $\Omega \Subset M$  be a relatively compact subset of  $M$ . We begin by establishing some mean value representation formulae involving the Green function of the operator  $\Delta_\alpha$  on  $\Omega$  with Dirichlet boundary conditions. Recall that  $G : \bar{\Omega} \times \bar{\Omega} \setminus \{x = y\} \rightarrow \mathbb{R}$  is a symmetric,  $L^1(\Omega \times \Omega)$  function satisfying the following properties:

- (a)  $G \in C^\infty(\Omega \times \Omega \setminus \{x = y\})$  and  $G(x, y) > 0$  for all  $x, y \in \Omega$  with  $x \neq y$ ;
- (b)  $\lim_{x \rightarrow y} G(x, y) = +\infty$  and  $G(x, y) = 0$  if  $x \in \partial\Omega$  (or  $y \in \partial\Omega$ );
- (c)  $\Delta_\alpha G(x, y) = -\delta_x(y)$  with respect to  $\alpha^2 \, dv_g$ , that is,

$$\varphi(x) = - \int_\Omega G(x, y) \Delta_\alpha \varphi(y) \alpha^2(y) \, dv_y \quad \forall \varphi \in C_c^\infty(\Omega).$$

For  $r > 0$  and  $x \in \Omega$ , we define the following set

$$\mathcal{B}_r(x) := \left\{ y \in \Omega \mid G(x, y) > r^{-1} \right\} \cup \{x\}. \quad (3.2.4)$$

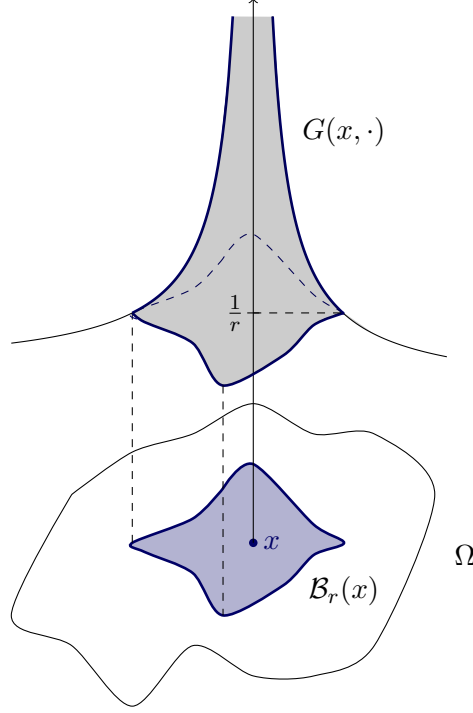

We adopt the convention  $G(x, x) = +\infty$  so that  $\mathcal{B}_r(x) = \{y \in \Omega \mid G(x, y) > r^{-1}\}$ . Observe that  $\mathcal{B}_r(x) \subset \Omega$  are open and relatively compact sets, moreover, for almost all  $r > 0$ ,  $\partial\mathcal{B}_r(x)$  is a smooth hypersurface. This is a consequence of Sard's theorem. In the following,  $da$  and  $dv$  represent the Riemannian surface and volume measure of  $\partial\mathcal{B}_r(x)$  and  $\mathcal{B}_r(x)$  respectively.

**Proposition 3.2.3.** *For every  $v \in C^\infty(\Omega)$  and almost every  $r > 0$ , the following representation formula holds*

$$v(x) = \int_{\partial\mathcal{B}_r(x)} v(y) |\nabla G(x, y)| \alpha^2(y) \, da_y - \int_{\mathcal{B}_r(x)} \left[ G(x, y) - \frac{1}{r} \right] \Delta_\alpha v(y) \alpha^2(y) \, dv_y \quad (3.2.5)$$

*Proof.* By the Green identity we have

$$\begin{aligned} v(x) &= - \int_{\mathcal{B}_r(x)} G(x, y) \Delta_\alpha v(y) \alpha^2(y) \, dv_y \\ &\quad + \int_{\partial\mathcal{B}_r(x)} \left( G(x, y) \frac{\partial v}{\partial \nu}(y) - v(y) \frac{\partial G}{\partial \nu}(x, y) \right) \alpha^2(y) \, da_y. \end{aligned}$$



Since  $\mathcal{B}_r(x)$  are level sets of  $G$ , we have  $\frac{\partial G}{\partial \nu} = -|\nabla G|$  thus

$$\begin{aligned} v(x) &= \int_{\partial \mathcal{B}_r(x)} v(y) |\nabla G(x, y)| \alpha^2(y) \, da_y + \frac{1}{r} \int_{\partial \mathcal{B}_r(x)} \frac{\partial v}{\partial \nu}(y) \alpha^2(y) \, da_y \\ &\quad - \int_{\mathcal{B}_r(x)} G(x, y) \Delta_\alpha v(y) \alpha^2(y) \, dv_y \\ &= \int_{\partial \mathcal{B}_r(x)} v(y) |\nabla G(x, y)| \alpha^2(y) \, da_y - \int_{\mathcal{B}_r(x)} \left[ G(x, y) - \frac{1}{r} \right] \Delta_\alpha v(y) \alpha^2(y) \, dv_y. \end{aligned}$$

□

In particular, if  $v \in C^2(\Omega)$  is  $\alpha$ -harmonic, i.e.  $\Delta_\alpha v = 0$  on  $\Omega$ , then

$$v(x) = \int_{\partial \mathcal{B}_r(x)} |\nabla G(x, y)| v(y) \alpha^2(y) \, da_y. \quad (3.2.6)$$

The formulae (3.2.6) and (3.2.5) are a generalization of some standard representation formula for the Laplace-Beltrami operator. See for instance the Appendix of [21], [76] or the very recent [29].

### 3.2.2 Distributional vs. potential $\alpha$ -subharmonic solutions

Before proving the monotone approximation result, we observe that the notion of  $\alpha$ -subharmonicity in the distributional sense is closely related to the notion of  $\alpha$ -subharmonic solutions in the sense of potential theory.

**Definition 3.2.4** (Subharmonicity in the sense of potential theory). *We say that an upper semicontinuous function  $u : \Omega \rightarrow [-\infty, +\infty)$  is  $\alpha$ -subharmonic in the sense of potential theory on  $\Omega$  if the following conditions hold*

- (i)  $\{x \in \Omega \mid u(x) > -\infty\} \neq \emptyset$ ;
- (ii) for all  $V \Subset \Omega$  and for every  $h \in C^2(V) \cap C^0(\overline{V})$  such that  $\Delta_\alpha h = 0$  in  $V$  with  $u \leq h$  on  $\partial V$ , then

$$u \leq h \quad \text{in } V.$$

The key observation, first noted by Sjörgen in [101, Theorem 1] in the Euclidean setting, is that every distributional  $\alpha$ -subharmonic function is almost everywhere equal to a function which is  $\alpha$ -subharmonic in the sense of potential theory. Note that in [101, Theorem 1], Sjörgen considers a wider class of elliptic differential operators. The drifted Laplace-Beltrami operator falls into that class.

More precisely, if  $v \in L^1(\Omega)$  satisfies  $\Delta_\alpha v \geq 0$  in the sense of distributions, then  $v$  is equal almost everywhere to an  $\alpha$ -subharmonic function in the sense of potential theory. Naturally, if  $v$  has some better regularity property, for example it is continuous, the equality holds everywhere. This fact holds true also in the Riemannian case, we sketch here the proof for clarity of exposition.

Recall that for every  $\varphi \in C_c^\infty(\Omega)$  we have

$$\varphi(x) = - \int_{\Omega} G(x, y) \Delta_{\alpha} \varphi(y) \alpha^2(y) \, dv_y.$$

Furthermore, since  $\Delta_{\alpha} v = d\eta^v$  is a positive Radon measure, we have

$$\int_{\Omega} v(x) \Delta_{\alpha} \varphi(x) \alpha^2(x) \, dv_x = \int_{\Omega} \varphi(x) \, d\eta_x^v$$

for every  $\varphi \in C_c^\infty(\Omega)$ . The measure  $d\eta^v$  is often referred to as the  $\Delta_{\alpha}$ -Riesz measure of  $v$ . By a direct computation we have

$$\begin{aligned} \int_{\Omega} v(x) \Delta_{\alpha} \varphi(x) \alpha^2(x) \, dv_x &= \int_{\Omega} \varphi(x) \, d\eta_x^v \\ &= - \int_{\Omega} \int_{\Omega} G(x, y) \Delta_{\alpha} \varphi(y) \alpha^2(y) \, dv_y \, d\eta_x^v \\ &= \int_{\Omega} - \left( \int_{\Omega} G(x, y) \, d\eta_x^v \right) \Delta_{\alpha} \varphi(y) \alpha^2(y) \, dv_y, \end{aligned}$$

hence,

$$\int_{\Omega} \left( v(y) + \int_{\Omega} G(x, y) \, d\eta_x^v \right) \Delta_{\alpha} \varphi(y) \alpha^2(y) \, dv_y = 0,$$

for every  $0 \leq \varphi \in C_c^\infty(\Omega)$ . In other words, the function

$$v + \int_{\Omega} G(x, \cdot) \, d\eta_x^v$$

is  $\alpha$ -harmonic in the sense of distributions. By [101, Theorem 1] of Sjörgen we know that  $\alpha$ -harmonic functions are almost everywhere equal to a function which is  $\alpha$ -harmonic in the sense of potential theory. When the operator at hand is the Euclidean Laplacian, this result is usually referred as Weyl's lemma. We conclude that

$$v \stackrel{a.e.}{=} h - \int_{\Omega} G(x, \cdot) \, d\eta_x^v, \quad (3.2.7)$$

where  $h$  is  $\alpha$ -harmonic in a strong sense. On the other hand, one can prove that the function

$$-G * d\eta^v = - \int_{\Omega} G(x, \cdot) \, d\eta_x^v \quad (3.2.8)$$

is  $\alpha$ -subharmonic in the sense of potential theory which concludes the sketch of the proof. For this latter statement, we refer to Section 6 of [21].

### 3.2.3 Proof of Theorem 3.2.2

In order to prove Theorem 3.2.2, we adopt a strategy laid out by Bonfiglioli and Lanconelli in [21], where they obtained some monotone approximation results for a wide class of

second order elliptic operators on  $\mathbb{R}^n$ . To do so, we begin by defining the following mean integral operators. If  $v$  is an upper semicontinuous function on  $\Omega$ ,  $x \in \Omega$  and  $r > 0$ , we set

$$m_r(v)(x) := \int_{\partial\mathcal{B}_r(x)} v(y) |\nabla_y G(x, y)| \alpha^2(y) \, da_y. \quad (3.2.9)$$

In particular, if  $v$  is an  $\alpha$ -subharmonic function in the sense of distributions we prove the following results.

**Proposition 3.2.5.** *Given a Riemannian manifold  $(M, g)$  and  $\Omega \Subset M$ , if  $v \in L^1(\Omega)$  is  $\alpha$ -subharmonic in the sense of distributions, then*

- (a)  $v(x) \leq m_r(v)(x)$  for almost every  $x \in \Omega$  and almost every  $r > 0$ ;
- (b) let  $0 < s < r$  then  $m_s(v)(x) \leq m_r(v)(x)$  almost everywhere in  $\Omega$ ;
- (c) for almost every  $x \in \Omega$  we have  $\lim_{r \rightarrow 0} m_r(v)(x) = v(x)$ ;
- (d) for every  $r > 0$   $m_r(v)$  is  $\alpha$ -subharmonic in the sense of potential on  $\Omega$ .

*Proof.* By the observation in the previous section, up to a choice of a good representative, we can assume that  $v$  is  $\alpha$ -subharmonic in the sense of potential, cf. Definition 3.2.4.

(a) Fix  $x_0 \in \Omega$  and  $r > 0$ , consider  $\varphi \in C^0(\partial\mathcal{B}_r(x_0))$  such that  $v \leq \varphi$  on  $\partial\mathcal{B}_r(x_0)$ . Let  $h : \mathcal{B}_r(x_0) \rightarrow \mathbb{R}$  be the (classical) solution to

$$\begin{cases} \Delta_\alpha h = 0 & \text{in } \mathcal{B}_r(x_0) \\ h = \varphi & \text{on } \partial\mathcal{B}_r(x_0). \end{cases} \quad (3.2.10)$$

Since  $v$  is  $\alpha$ -subharmonic in the sense of potential, then  $v \leq h$  in  $\mathcal{B}_r(x_0)$ . By Proposition 3.2.3 we have

$$v(x_0) \leq h(x_0) = \int_{\partial\mathcal{B}_r(x_0)} \varphi(y) |\nabla_y G(x_0, y)| \, da_y^\alpha \quad (3.2.11)$$

where  $da_y^\alpha = \alpha^2(y) \, da_y$ . Since  $v$  is upper semicontinuous on  $\partial\mathcal{B}_r(x_0)$ , there exists a sequence  $\{\varphi_i\}_i \subset C^0(\partial\mathcal{B}_r(x_0))$  such that  $\varphi_i(y) \searrow v(y)$  almost everywhere on  $\partial\mathcal{B}_r(x_0)$ . Applying (3.2.11) to each  $\varphi_i$  we obtain by Dominated Convergence that

$$v(x_0) \leq \int_{\partial\mathcal{B}_r(x_0)} v(y) |\nabla_y G(x_0, y)| \, da_y^\alpha = m_r(v)(x_0).$$

(b) Fix  $0 < s < r$ , let  $\varphi$  and  $h$  be as in (a) so that  $v \leq h$  on  $\mathcal{B}_r(x_0)$ . By Proposition 3.2.3 we have

$$m_s(v)(x_0) \leq \int_{\partial\mathcal{B}_s(x_0)} h(y) |\nabla_y G(x_0, y)| \, da_y^\alpha = h(x_0) = \int_{\partial\mathcal{B}_r(x_0)} \varphi(y) |\nabla_y G(x_0, y)| \, da_y^\alpha.$$

Taking a monotone sequence of continuous functions on the boundary  $\varphi_i \searrow v$  and proceeding as above we conclude

$$m_s(v)(x_0) \leq \int_{\partial\mathcal{B}_r(x_0)} \varphi_i(y) |\nabla_y G(x_0, y)| \, da_y^\alpha \longrightarrow m_r(v)(x_0).$$

(c) This property is a consequence of the fact that  $v$  is (almost everywhere) equal to an upper semicontinuous function. Fix  $x_0 \in \Omega$  and  $\varepsilon > 0$  there exists a small enough neighborhood of  $x_0$ ,  $V(x_0)$ , such that

$$v(y) < v(x_0) + \varepsilon$$

on  $V(x_0)$ . Taking for  $r > 0$  small enough so that  $\partial\mathcal{B}_r(x_0) \subseteq V(x_0)$ , we have

$$m_r(v)(x_0) \leq v(x_0) + \varepsilon.$$

Recall that the function constant to 1 is  $\alpha$ -harmonic on  $\Omega$ . By (i),  $v(x_0) \leq m_r(v)(x_0)$  hence

$$m_r(v)(x_0) - \varepsilon \leq v(x_0) \leq m_r(v)(x_0).$$

Letting  $\varepsilon$ , and thus  $r$  go to 0, we obtain desired property.

(d) This last property is a consequence of the decomposition of  $\alpha$ -subharmonic functions observed in (3.2.7). Integrating against  $|\nabla G|\alpha^2$  both sides of (3.2.7) we obtain

$$m_r(v)(x) = h(x) - m_r(G * d\eta^v)(x).$$

The desired property follows from the fact that the mean integral  $-m_r(G * d\eta^v)$  is  $\alpha$ -subharmonic in the sense of potential. For details we refer to Section 6 of [21].

□

The next step is to take a convolution of the mean integral functions  $m_r(v)$  so to obtain smooth functions which produce the desired approximating sequence  $\{v_k\}_k$ .

*Proof of Theorem 3.2.2.* Let  $\varphi \in C_c^1([0, 1])$  be a nonnegative function with unitary  $L^1$ -norm, we define

$$v_k(x) := k \int_0^{+\infty} \varphi(ks) m_s(v)(x) ds. \quad (3.2.12)$$

As shown in [21] the functions defined by (3.2.12) are smooth.

The monotonicity of  $\{v_k\}$  follows immediately from the monotonicity of  $m_r(v)$  with respect to  $r$ . Combining this with property (c) and (a) of Proposition 3.2.5 we obtain (i) by monotone convergence. The proof of (ii) is a consequence of (d) in Proposition 3.2.5. To see this, let  $\psi \in C_c^\infty(M)$ , then by Fubini-Tonelli we have

$$\begin{aligned} \int_M v_k(x) \Delta_\alpha \psi(x) &= \int_M \left( k \int_0^{+\infty} \varphi(ks) m_s(v)(x) ds \right) \Delta_\alpha \psi(x) \\ &= k \int_0^{+\infty} \varphi(ks) \left( \int_M m_s(v)(x) \Delta_\alpha \psi(x) \right) ds \geq 0. \end{aligned}$$

Note that  $\varphi$  is compactly supported on  $[0, 1]$ ,  $\psi \in C_c^\infty(M)$  and  $m_s(v)(x)$  are upper semicontinuous functions bounded from below by  $v \in L^1(M)$ . For details on the proof of (i) and (ii) we refer to [21, Theorem 7.1]. The convergence in  $L^1(\Omega)$  follows from (i), using

the fact that  $|v_k| \leq \max\{|v|, |v_1|\} \in L^1(\Omega)$  and the dominated convergence theorem. For the uniform estimate of (iv), it is enough to observe that 1 is an  $\alpha$ -harmonic function on  $\Omega$  and  $\varphi$  has unitary  $L^1$  norm, hence,

$$v_k(x) = k \int_0^{+\infty} \varphi(ks) m_s(v)(x) ds \leq \operatorname{ess\,sup}_{\Omega} v k \int_0^{+\infty} \varphi(ks) m_s(1)(x) ds = \operatorname{ess\,sup}_{\Omega} v.$$

This concludes the proof of Theorem 3.2.2.  $\square$

**Remark 3.2.6.** Note that in the last estimate, one actually has

$$\operatorname{ess\,sup}_{\Omega} v_k \leq \operatorname{ess\,sup}_{\mathcal{B}_{1/k}(x)} v \leq \operatorname{ess\,sup}_{\Omega} v.$$

This observation will be crucial later on.

### 3.2.4 Proof of Theorem 3.1.7

Finally, we resume the proof of Theorem 3.1.7 from Theorem 3.2.2. If  $\{v_k\}_k$  is the approximating sequence for the function  $v = \frac{u}{\alpha}$ , we define  $u_k := \alpha v_k$ . By Lemma 3.2.3,  $\{u_k\}_k$  is an approximating sequence for  $u$  as it satisfies (i) – (iii) of Theorem 3.1.7. The proof is trivial and is therefore omitted. A little more effort is required to show that if  $\sup_{\Omega} v_k \leq \operatorname{ess\,sup}_{\Omega} v$ , then  $\sup_{\Omega} u_k \leq 2 \operatorname{ess\,sup}_{\Omega} u$  for  $k$  large enough, at least when  $u \geq 0$ .

To this end, fix  $x \in \Omega$ . As noted in Remark 3.2.6 we have

$$u_k(x) = \alpha(x)v_k(x) \leq \alpha(x) \operatorname{ess\,sup}_{\mathcal{B}_{1/k}(x)} v \leq \frac{\alpha(x)}{\inf_{\mathcal{B}_{1/k}(x)} \alpha} \operatorname{ess\,sup}_{\Omega} u.$$

Furthermore, for every  $y \in \mathcal{B}_{1/k}(x)$  we estimate

$$\frac{\alpha(x)}{\alpha(y)} \leq \frac{|\alpha(x) - \alpha(y)|}{\alpha(y)} + 1 \leq \frac{r_k(x) \sup_{\Omega} |\nabla \alpha|}{\inf_{\Omega} \alpha} + 1 \quad (3.2.13)$$

where  $r_k(x) = \sup\{d(x, z) : z \in \mathcal{B}_{1/k}(x)\}$ . Next, we show that the function  $r_k(x)$  can be uniformly bounded so that (3.2.13) is bounded above by 2.

**Lemma 3.2.7.** *There exists some  $k_0 \in \mathbb{N}$  such that*

$$r_k(x) \leq \frac{\inf_{\Omega} \alpha}{\sup_{\Omega} |\nabla \alpha|} =: c \quad \forall x \in \Omega, \quad \forall k \geq k_0.$$

*Proof.* Suppose by contradiction that there exists a sequence of points  $\{x_k\}_k \subset \Omega$  such that  $r_k(x_k) > c$  for every  $k \in \mathbb{N}$ . By definition of  $r_k(x_k)$ , there exists a sequence of points  $\{y_k\}_k \subset \mathcal{B}_{1/k}(x_k)$  such that  $d(y_k, x_k) > c$ . Since  $\Omega$  is relatively compact, up to a subsequence, we can assume that  $x_k \rightarrow x_{\infty} \in \overline{\Omega}$  and  $y_k \rightarrow y_{\infty} \in \overline{\Omega}$ . Since  $y_k \in \mathcal{B}_{1/k}(x_k)$  we have

$$G(x_k, y_k) > k \rightarrow +\infty. \quad (3.2.14)$$

Note also that the Green function  $G$  is smooth and hence continuous on  $\Omega \times \Omega \setminus \{x = y\}$ . Note that since  $d(x_k, y_k) > c$ , then  $d(x_\infty, y_\infty) \geq c$ , in particular we deduce that  $x_\infty \notin \partial\Omega$  because the Green function  $G$  vanishes on the boundary of  $\Omega$ . If  $x_\infty \in \Omega$  is not on the boundary, fix  $\bar{k} \in \mathbb{N}$ . By (3.2.14) and continuity of the Green function we have  $G(y_\infty, x_\infty) > \bar{k}$  which implies that  $y_\infty \in \mathcal{B}_{1/\bar{k}}(x_\infty)$ . In particular we have  $d(x_\infty, y_\infty) \leq r_{\bar{k}}(x_\infty) \rightarrow 0$  as  $\bar{k} \rightarrow +\infty$ , which is a contradiction since  $d(x_\infty, y_\infty) \geq c$ . Indeed, for every  $x \in \Omega$ ,

$$\lim_{k \rightarrow +\infty} r_k(x) = 0.$$

Clearly,  $r_k(x)$  is a monotone decreasing sequence in  $k$ . Suppose its limit is some  $r_0 > 0$  this implies that  $r_k(x) \geq r_0$  for all  $k$ . In particular, for every  $k$  there exists some  $z_k \in \mathcal{B}_{1/k}(x)$  such that  $d(z_k, x) = \frac{r_0}{2}$ . Up to subsequences,  $z_k \rightarrow \bar{z}$  and  $\bar{z} \in \mathcal{B}_{1/k}(x)$  for every  $k$ . However

$$\bigcap_{k=1}^{\infty} \mathcal{B}_{1/k}(x) = \{x\},$$

so  $\bar{z} = x$  which is a contradiction since  $d(\bar{z}, x) = \frac{r_0}{2}$ .  $\square$

Thanks to Lemma 3.2.7, up to taking  $k$  large enough, we have

$$\alpha(x) \leq 2\alpha(y) \quad \forall x \in \Omega \text{ and } \forall y \in \mathcal{B}_{1/k}(x),$$

hence,

$$u_k(x) \leq \frac{\alpha(x)}{\inf_{\mathcal{B}_{1/k}(x)} \alpha} \operatorname{ess\,sup}_\Omega u \leq 2 \operatorname{ess\,sup}_\Omega u \quad \forall x \in \Omega.$$

Clearly, if we don't assume  $u \geq 0$ , the estimate in term of  $L^\infty$  norms easily follows. This concludes the proof of Theorem 3.1.7.

### 3.2.5 Remarks on the global case

A careful analysis of above proofs shows that the monotone approximation results can be obtained globally on the whole manifold  $M$  as long as there exists a minimal positive Green function for the operator  $\Delta_\alpha$  and the super level sets  $\mathcal{B}_r(x)$  are compact. Not all Riemannian manifolds, however, satisfy these conditions. We recall the following

**Definition 3.2.8** ( $\alpha$ -non-parabolic manifold). *A Riemannian manifold  $(M, g)$  is said to be  $\alpha$ -non-parabolic if there exists a minimal positive Green function  $G$  for the operator  $\Delta_\alpha$ . Moreover, if this Green function satisfies*

$$\lim_{y \rightarrow \infty} G(x, y) = 0, \tag{3.2.15}$$

*the manifold  $M$  is said to be strongly  $\alpha$ -non-parabolic.*

Note that compact Riemannian manifold are always  $\alpha$ -parabolic thus we focus on the complete, non-compact case. It is also known that if  $(M, g)$  is a geodesically complete,  $\alpha$ -non-parabolic manifold, then

$$\int_1^\infty \frac{t}{\operatorname{vol}_\alpha(B_t(x))} dt < \infty \tag{3.2.16}$$

where  $\text{vol}_\alpha(B_t(p))$  is the volume of the geodesic ball of radius  $t$  and center  $x$  with respect to the measure  $\alpha^2 \, \text{d}v_g$ . See for instance Theorem 9.7 of [43]. Furthermore, if we assume a nonnegative  $m$ -Bakry-Émery Ricci tensor  $\text{Ric}_f^m := \text{Ric} + \text{Hess}(f) - \frac{1}{m}df \otimes df \geq 0$  with  $f = -2 \log \alpha$ , it is possible to prove some Li-Yau type estimates for the heat kernel, see Theorems 5.6 and 5.8 in [27]. Integrating in time these estimates we obtain the following bounds for the Green function

$$C^{-1} \int_{d(x,y)}^\infty \frac{t}{\text{vol}_\alpha(B_t(x))} \, dt \leq G(x, y) \leq C \int_{d(x,y)}^\infty \frac{t}{\text{vol}_\alpha(B_t(x))} \, dt.$$

In particular if (3.2.16) holds true and  $\text{Ric}_f^m \geq 0$ , the previous estimate implies that the manifold at hand is strongly  $\alpha$ -non parabolic. It would be interesting to investigate which geometric conditions on the manifold  $(M, g)$  imply the existence of a function  $\alpha$  such that (3.2.16) and  $\text{Ric}_f^m \geq 0$  hold true.

### 3.3 A counterexample for $p = 1$

For the case  $p = 1$ , as stressed in the introduction to Part II, the best result we have is the already cited [70, Theorem II] by Marini and Veronelli, which ensures the  $L^1$  positivity preserving property for complete manifolds satisfying condition (3.1.1). In particular, using a construction suggested by Veronelli, in this section we provide a counterexample to the  $L^1$  positivity preservation, proving that condition (3.1.1) is optimal. As a consequence, it follows that for  $p = 1$  the BMS conjecture is in general false.

**Theorem 3.3.1.** *For every  $\varepsilon > 0$ , there exists a 2-dimensional Riemannian manifold  $(M, g)$  whose Gaussian curvature satisfies*

$$K(x) \sim -Cr(x)^{2+\varepsilon},$$

such that the  $L^1$  positivity preserving property fails on  $M$ . Here  $r(x)$  denotes the Riemannian distance from some fixed pole.

*Proof.* Fix  $\varepsilon > 0$  and consider the 2-dimensional model manifold  $M = \mathbb{R}_+ \times_\sigma \mathbb{S}^1$ , that is  $\mathbb{R}_+ \times \mathbb{S}^1$  with the metric  $g = dt^2 + \sigma^2(t)d\theta^2$ . Here  $d\theta^2$  is the standard round metric on  $\mathbb{S}^1$  and  $\sigma = \sigma_\varepsilon$  is a  $C^\infty((0, +\infty))$  function satisfying

$$\sigma(t) = \begin{cases} j(t) & t > t_\varepsilon \\ t & t < \frac{1}{4} \end{cases}.$$

Here  $t_\varepsilon = (2(1 + \varepsilon)\varepsilon)^{-1/2\varepsilon}$  and the function  $j$  is defined as

$$j(t) = \frac{e^{-t^2+2\varepsilon}}{t^{1+\varepsilon}}.$$

By a direct computation we have

$$\begin{aligned} j'(t) &= -(1 + \varepsilon)e^{-t^2+2\varepsilon} \left( 2t^\varepsilon + \frac{1}{t^{2+\varepsilon}} \right) \\ j''(t) &= (1 + \varepsilon)e^{-t^2+2\varepsilon} \left[ 2t^{\varepsilon-1} + 4(1 + \varepsilon)t^{1+3\varepsilon} + (2 + \varepsilon)\frac{1}{t^{3+\varepsilon}} \right]. \end{aligned}$$

As a result, outside of a compact set we have the following asymptotic estimate for the Gaussian curvature:

$$\begin{aligned} K(t, \theta) &= -\frac{j''(t)}{j(t)}g \\ &= -(1 + \varepsilon) \left[ 2t^{2\varepsilon} + 4(1 + \varepsilon)t^{2+4\varepsilon} + (2 + \varepsilon)\frac{1}{t^2} \right] g \\ &\sim -4(1 + \varepsilon)^2 t^{2+4\varepsilon} g \end{aligned}$$

as  $t \rightarrow +\infty$ . Next we define the function  $U(t, \theta) = u(t) = (e^{t^{2+2\varepsilon}} - e^{t_\varepsilon^{2+2\varepsilon}})_+$  and prove that it satisfies

$$\Delta U \geq U$$

in the sense of distributions. If  $t > t_\varepsilon$ , by direct computation we have

$$\begin{aligned} u'(t) &= 2(1 + \varepsilon)t^{1+2\varepsilon} e^{t^{2+2\varepsilon}} \\ u''(t) &= 2(1 + \varepsilon)e^{t^{2+2\varepsilon}} \left[ 2(1 + \varepsilon)t^{2+4\varepsilon} + (1 + 2\varepsilon)t^{2\varepsilon} \right] \end{aligned}$$

thus

$$\Delta U - U = u''(t) + \frac{j'(t)}{j(t)}u'(t) - u(t) = e^{t^{2+2\varepsilon}} \left[ 2(1 + \varepsilon)\varepsilon t^{2\varepsilon} - 1 \right] + e^{t_\varepsilon^{2+2\varepsilon}} \geq 0.$$

On the other hand, if  $t < t_\varepsilon$  the function  $U$  is identically zero, so that  $\Delta U - U \geq 0$  also for  $t \in (0, t_\varepsilon)$ . To see that  $\Delta U \geq U$  in the sense of distributions on the whole manifold we take  $0 \leq \varphi \in C_c^\infty(M)$  and set  $\bar{M} := M \setminus B_{t_\varepsilon}(0)$ . Then we compute

$$\begin{aligned} \int_M U(\Delta\varphi - \varphi) \, dv &= \int_{\bar{M}} U(\Delta\varphi - \varphi) \, dv \\ &= - \int_{\bar{M}} g(\nabla\varphi, \nabla U) \, dv + \int_{\partial\bar{M}} U \frac{\partial\varphi}{\partial\nu} \, da - \int_{\bar{M}} U\varphi \, dv \\ &= - \int_{\bar{M}} g(\nabla\varphi, \nabla U) \, dv - \int_{\bar{M}} U\varphi \, dv \\ &= \int_{\bar{M}} \Delta U \varphi \, dv - \int_{\partial\bar{M}} \frac{\partial U}{\partial\nu} \varphi \, da - \int_{\bar{M}} U\varphi \, dv \\ &= \int_{\bar{M}} \Delta U \varphi \, dv + \int_{\partial B_{t_\varepsilon}(0)} \frac{\partial U}{\partial t} \varphi \, da - \int_{\bar{M}} U\varphi \, dv \\ &= \int_{\bar{M}} (\Delta U - U)\varphi \, dv + \int_{\partial B_{t_\varepsilon}(0)} u' \varphi \, da \geq 0. \end{aligned}$$

On the other hand we have:

$$\int_M |U| \, dv = \omega_m \int_0^{+\infty} u(t)j(t) \, dt = \int_{t_\varepsilon}^{+\infty} \frac{1}{t^{1+\varepsilon}} \, dt < +\infty.$$

In conclusion, if we set  $V = -U$  we have  $V \in L^1(M)$  and  $(-\Delta + 1)V \geq 0$  but  $V \leq 0$ , which contradicts the validity of the  $L^1$  positivity preserving property on  $M$ .  $\square$



**Remark 3.3.2.** Using a simple trick introduced in [57], the counterexample in dimension 2 of Theorem 3.3.1 can be used to construct counterexamples to the  $L^1$  positivity preserving property in arbitrary dimensions  $n \geq 2$ . It suffices to take the product of the 2 dimensional model manifold  $M$  with an arbitrary  $n - 2$  dimensional closed Riemannian manifold. Extending the function which provides the counterexample on  $M$  to the whole product produces a counterexample in a manifold of dimension  $n$ .



---

## $L^p_{loc}$ positivity preservation and Liouville-type theorems<sup>1</sup>

---

Starting from Definition II.A, in this chapter we deal with a notion of positivity preserving property for Schrödinger operators of the form  $-\Delta + \lambda$ , where  $\lambda$  is a positive and locally bounded function.

We stress that the results we obtained can be read as  $L^p$  Liouville-type theorems when one deals with nonnegative solutions to  $\Delta u \geq \lambda u$ . In this direction we have a more direct comparison with the existing literature where, typically, one introduces a further pointwise control on the growth of the function and requires much more regularity on the solution. In the next sections we shall comment on these aspects.

### 4.1 Some preliminary results

In what follows, if  $u$  is a real-valued function we denote

$$u^+ := \max\{u, 0\} \quad \text{and} \quad u^- := \max\{-u, 0\}.$$

We start recalling the Brezis-Kato inequality in a general Riemannian setting. This result is obtained in [85] for the general inequality  $\Delta u \geq f \in L^1_{loc}$  and it is a slightly more general version of the one presented in Theorem 3.1.9.

**Theorem 4.1.1** (Brezis-Kato inequality). *Let  $(M, g)$  be a possibly incomplete Riemannian manifold and  $\lambda$  a measurable function.*

*If  $u \in L^1_{loc}(M)$  is so that  $\lambda u \in L^1_{loc}(M)$  and satisfies  $-\Delta u + \lambda u \leq 0$  in the sense of distributions, then  $-\Delta u^+ + \lambda u^+ \leq 0$  in the sense of distributions.*

As a consequence, in the next proposition we get a refinement of the regularity result obtained in [85] for complete manifolds. The inequality (4.1.1) will be the key tool in the proof of the positivity preserving properties stated in Section 4.2.

---

<sup>1</sup>The content of this chapter is based on [17], a joint work with Prof. Alberto Farina and Prof. Stefano Pigola.

**Proposition 4.1.2.** *Let  $(M, g)$  be a complete Riemannian manifold and  $0 \leq \lambda \in L_{loc}^\infty(M)$ . Assume that  $u \in L_{loc}^1(M)$  satisfies  $-\Delta u + \lambda u \geq 0$  in the sense of distributions.*

*Then,  $u^- \in L_{loc}^\infty(M)$  and  $(u^-)^{\frac{p}{2}} \in W_{loc}^{1,2}(M)$  for every  $p \in (1, +\infty)$ . Moreover,  $u^-$  satisfies*

$$(p-1) \int_M \lambda (u^-)^p \varphi^2 \, dv \leq \int_M (u^-)^p |\nabla \varphi|^2 \, dv \quad (4.1.1)$$

for every  $0 \leq \varphi \in C_c^{0,1}(M)$ .

*Proof.* By the Brezis-Kato inequality, the function  $u^- \in L_{loc}^1(M)$  satisfies  $\Delta u^- \geq \lambda u^-$  in the sense of distributions. Therefore, by [87, Theorem 3.1] it follows that  $u^- \in L_{loc}^\infty(M)$  and  $(u^-)^{\frac{p}{2}} \in W_{loc}^{1,2}(M)$  for every  $p \in (1, +\infty)$ .

To prove (4.1.1), let  $\delta > 0$  and set  $v_\delta := u^- + \delta \in L_{loc}^\infty(M) \cap W_{loc}^{1,2}(M)$ . Clearly, for every  $q > 0$  the function  $v_\delta^q$  belongs to  $L_{loc}^\infty(M) \cap W_{loc}^{1,2}(M)$  and by [87, Lemma 5.4] its weak gradient satisfies

$$\nabla v_\delta^q = q v_\delta^{q-1} \nabla v_\delta. \quad (4.1.2)$$

Moreover,  $\Delta v_\delta \geq \lambda u^-$  in the sense of distributions, implying

$$\int_M \lambda u^- \psi \, dv + \int_M g(\nabla v_\delta, \nabla \psi) \leq 0$$

for every  $0 \leq \psi \in W_c^{1,2}(M)$ , where the subscript “c” stands for compactly supported. In particular, choosing  $\psi = v_\delta^{p-1} \varphi^2$  with  $\varphi \in C_c^{0,1}(M)$  and using (4.1.2), we get

$$\begin{aligned} 0 &\geq \int_M \lambda u^- v_\delta^{p-1} \varphi^2 \, dv + (p-1) \int_M v_\delta^{p-2} \varphi^2 |\nabla v_\delta|^2 \, dv \\ &\quad + 2 \int_M \varphi v_\delta^{p-1} g(\nabla v_\delta, \nabla \varphi) \, dv. \end{aligned}$$

By Cauchy-Schwarz inequality and Young’s inequality, for any  $\epsilon \in (0, p-1)$  we have

$$\begin{aligned} 2\varphi v_\delta^{p-1} g(\nabla v_\delta, \nabla \varphi) &\geq -2\varphi v_\delta^{p-1} |\nabla v_\delta| |\nabla \varphi| \\ &\geq -\epsilon \varphi^2 v_\delta^{p-2} |\nabla v_\delta|^2 - \epsilon^{-1} v_\delta^p |\nabla \varphi|^2 \end{aligned}$$

and thus

$$\begin{aligned} 0 &\geq \int_M \lambda u^- v_\delta^{p-1} \varphi^2 \, dv + (p-1-\epsilon) \int_M v_\delta^{p-2} \varphi^2 |\nabla v_\delta|^2 \, dv \\ &\quad - \epsilon^{-1} \int_M v_\delta^p |\nabla \varphi|^2 \, dv. \end{aligned}$$

As  $\epsilon \rightarrow p-1$  we get

$$(p-1) \int_M \lambda u^- v_\delta^{p-1} \varphi^2 \, dv \leq \int_M v_\delta^p |\nabla \varphi|^2 \, dv$$

that, together with the fact that

$$\begin{aligned} \lambda u^- v_\delta^{p-1} &\xrightarrow{\delta \rightarrow 0} \lambda (u^-)^p && \text{in } L^1_{loc}(M) \\ v_\delta^p &\xrightarrow{\delta \rightarrow 0} (u^-)^p && \text{in } L^1_{loc}(M) \end{aligned}$$

by Dominated Convergence Theorem, implies

$$(p-1) \int_M \lambda (u^-)^p \varphi^2 \, dv \leq \int_M (u^-)^p |\nabla \varphi|^2 \, dv$$

obtaining the claim.  $\square$

## 4.2 $L^p_{loc}$ positivity preserving property

In this section we face up the question of the  $L^p_{loc}$  positivity preserving property for  $p \in (1, +\infty)$ , considering complete Riemannian manifolds and not requiring any curvature assumption.

Clearly, if the manifold is non-compact, we do not have any control on the growth at “infinity” of (the  $p$ -norm of) the general function  $u \in L^p_{loc}(M)$ , making it impossible to retrace step by step what has been done in [87] and [85] in the  $L^p$  case. In addition, we also point out that we cannot expect to obtain a genuine positivity preserving property on the whole family of functions  $L^p_{loc}(M)$ . Indeed, if  $\lambda$  is a positive constant, then  $u(x) = -e^{\sqrt{\lambda}x}$  is a negative function that solves  $-u'' + \lambda u = 0$  in  $\mathbb{R}$ . So the  $L^p_{loc}$  positivity preserving property fails in general complete Riemannian manifolds.

Taking into account what we have observed so far, it seems natural to limit ourselves to the class of  $L^p_{loc}$  functions whose  $p$ -norms satisfy a suitable (sub-exponential) growth condition.

We start with the following iterative lemma.

**Lemma 4.2.1.** *Let  $A > 0$  and  $f : [A, +\infty) \rightarrow (0, +\infty)$  be a nondecreasing function. Suppose there exist  $\alpha > 0, \delta \geq 0, \beta \geq 1$  and  $\gamma > 0$  so that*

$$f(r) \leq \frac{1}{\alpha(1+r)^{-\delta}h^\gamma + \beta} f(r+h) \tag{4.2.1}$$

for every  $r \geq A$  and every  $h > 0$ .

Then, for every fixed  $h > 0$  the function  $f$  satisfies

$$f(R) \geq f(A) \left( \alpha(1+R-h)^{-\delta}h^\gamma + \beta \right)^{\frac{R-A}{h}-1}$$

for every  $R \geq A+h$ .

*Proof.* Fixed  $h > 0$ , by assumption we have  $f(r) \leq \left( \alpha(1+r)^{-\delta}h^\gamma + \beta \right)^{-1} f(r+h)$  for any

$r \geq A$ . Iterating, for every  $n \in \mathbb{N}$  we get

$$\begin{aligned} f(r) &\leq \left(\alpha(1+r)^{-\delta}h^\gamma + \beta\right)^{-1} f(r+h) \\ &\leq \left(\alpha(1+r)^{-\delta}h^\gamma + \beta\right)^{-1} \left(\alpha(1+r+h)^{-\delta}h^\gamma + \beta\right)^{-1} f(r+2h) \\ &\leq \left(\alpha(1+r+h)^{-\delta}h^\gamma + \beta\right)^{-2} f(r+2h) \\ &\leq \dots \leq \left(\alpha(1+r+(n-1)h)^{-\delta}h^\gamma + \beta\right)^{-n} f(r+nh) \end{aligned}$$

for any  $r \geq A$ . It follows that for every  $R > A$

$$\begin{aligned} f(R) &\geq f(A+nh) \\ &\geq \left(\alpha(1+A+(n-1)h)^{-\delta}h^\gamma + \beta\right)^n f(A) \\ &\geq \left(\alpha(1+A+(n-1)h)^{-\delta}h^\gamma + \beta\right)^{\frac{R-A}{h}-1} f(A), \end{aligned}$$

where  $n = n(R, A, h)$  is the unique natural number satisfying  $A + (n+1)h \geq R \geq A + nh$ . In particular, if  $R \geq A + h$ , then  $\frac{R-A}{h} \geq 1$  obtaining

$$\begin{aligned} f(R) &\geq \left(\alpha(1+A+(n-1)h)^{-\delta}h^\gamma + \beta\right)^{\frac{R-A}{h}-1} f(A) \\ &\geq \left(\alpha(1+R-h)^{-\delta}h^\gamma + \beta\right)^{\frac{R-A}{h}-1} f(A) \end{aligned}$$

since  $\frac{R-A}{h} - 1 \geq n - 1$ . This concludes the proof.  $\square$

Combining Lemma 4.2.1 with Proposition 4.1.2 and with the choice standard family of rotationally symmetric cut-off functions, we get the following theorem.

**Theorem 4.2.2** (Generalized  $L^p_{loc}$  positivity preserving property). *Let  $(M, g)$  be a complete Riemannian manifold,  $\lambda \in L^\infty_{loc}(M)$  a positive function and  $p \in (1, +\infty)$ . Moreover, assume there exist  $o \in M$  and a constant  $C > 0$  so that*

$$\lambda(x) \geq \frac{C}{(1 + d^M(x, o))^{2-\epsilon}} \quad \forall x \in M,$$

where  $\epsilon \in (0, 2]$  and  $d^M$  is the intrinsic distance on  $M$ .

If  $u \in L^p_{loc}(M)$  satisfies  $-\Delta u + \lambda u \geq 0$  in the sense of distributions and

$$\int_{B_R(o)} (u^-)^p \, dv = o\left(e^{\theta R^{\frac{\epsilon}{2}}}\right) \quad \text{as } R \rightarrow +\infty, \quad (4.2.2)$$

where  $\theta = \sqrt{\frac{(p-1)C}{e-1}}$ , then  $u \geq 0$ .

**Remark 4.2.3** (A Liouville-type theorem). It clearly follows that the unique nonpositive  $L^p_{loc}$  distributional solution to  $-\Delta u + \lambda u \geq 0$  that satisfies condition (4.2.2) is the null function. In this sense, Theorem 4.2.2 can be read as an  $L^p$  Liouville-type theorem.

**Remark 4.2.4.** The case  $\epsilon > 2$  can be considered by reducing the problem to the case  $\epsilon = 2$ , since

$$\lambda(x) \geq C(1 + d^M(x, o))^{\epsilon-2} \geq C \quad \forall x \in M.$$

*Proof.* Let  $u \in L^p_{loc}(M)$  be a distributional solution to  $-\Delta u + \lambda u \geq 0$  satisfying (4.2.2). For any fixed  $a > 0$  and  $b > a$ , consider the function  $\eta_{a,b} \in C^{0,1}([0, +\infty))$  so that

$$\begin{cases} \eta_{a,b} \equiv 1 & \text{in } [0, a] \\ \eta_{a,b}(t) = \frac{b-t}{b-a} & \text{in } [a, b] \\ \eta_{a,b} \equiv 0 & \text{in } [b, +\infty). \end{cases}$$

In particular,  $|\eta'_{a,b}(t)| \leq \frac{1}{b-a}$  almost everywhere in  $[0, +\infty)$ .

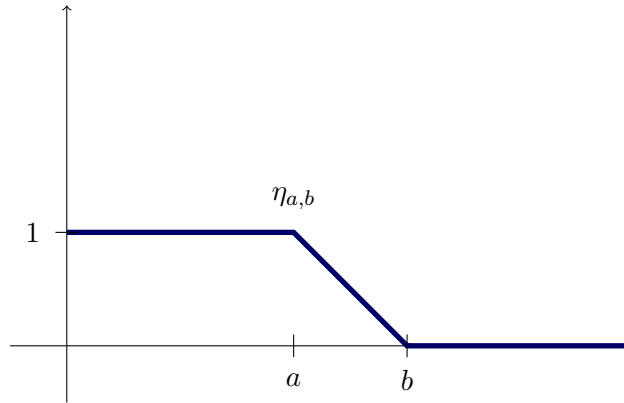

Set  $\varphi_{a,b}(x) := \eta_{a,b}(d(x, o))$ , where  $d(\cdot, \cdot)$  is the intrinsic distance on  $M$ . Then,  $\varphi_{a,b} \in C^{0,1}(M)$  and satisfies

$$\begin{cases} \varphi_{a,b} \geq 0 & \text{in } M \\ |\nabla \varphi_{a,b}(x)| \leq \frac{1}{b-a} & \text{a.e. in } M \\ \varphi_{a,b} \equiv 0 & \text{in } M \setminus \overline{B_b(o)} \\ \varphi_{a,b} \equiv 1 & \text{in } B_a(o). \end{cases}$$

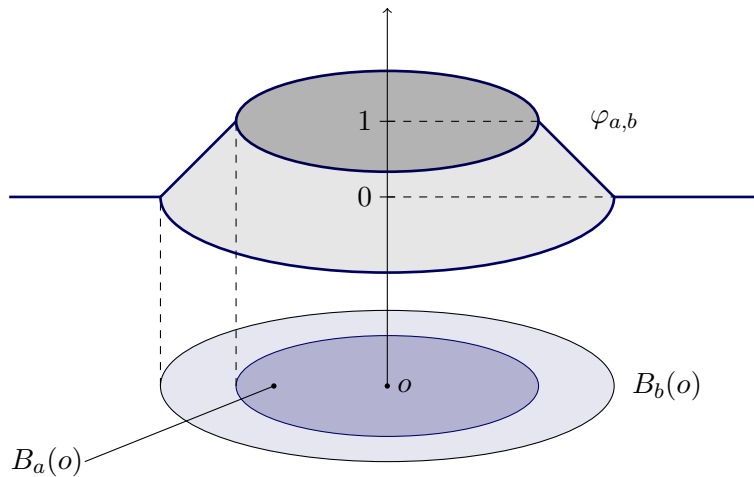

Using  $\varphi = \varphi_{a,b}$  in (4.1.1), we get

$$\begin{aligned} \frac{1}{(b-a)^2} \int_{B_b(o) \setminus B_a(o)} (u^-)^p \, dv &\geq (p-1) \int_{B_a(o)} \lambda (u^-)^p \, dv \\ &\geq (p-1) \int_{B_a(o)} \frac{C}{(1+d^M(\cdot, o))^{2-\epsilon}} (u^-)^p \, dv \\ &\geq (p-1) \frac{C}{(1+a)^{2-\epsilon}} \int_{B_a(o)} (u^-)^p \, dv \end{aligned}$$

and, by adding

$$\frac{1}{(b-a)^2} \int_{B_a(o)} (u^-)^p \, dv$$

to both sides of previous inequality, we obtain

$$\left( (p-1) \frac{C}{(1+a)^{2-\epsilon}} + \frac{1}{(b-a)^2} \right) \int_{B_a(o)} (u^-)^p \, dv \leq \frac{1}{(b-a)^2} \int_{B_b(o)} (u^-)^p \, dv$$

for every fixed  $a > 0$  and  $b > a$ . In particular, it implies that

$$\int_{B_a(o)} (u^-)^p \, dv \leq \frac{1}{(p-1)C(1+a)^{\epsilon-2}h^2 + 1} \int_{B_{a+h}(o)} (u^-)^p \, dv \quad (4.2.3)$$

for every  $a > 0$  and  $h > 0$ .

If we suppose that  $u^- \neq 0$ , then there exists  $A > 0$  so that

$$\int_{B_A(o)} (u^-)^p \, dv > 0.$$

By (4.2.3) we can apply Lemma 4.2.1 to

$$f : a \mapsto \int_{B_a(o)} (u^-)^p \, dv$$

in  $[A, +\infty)$ , with  $\gamma = 2$ ,  $\delta = 2 - \epsilon$ ,  $\alpha = (p-1)C$  and  $\beta = 1$  and we get that for any  $h > 0$  and for any  $R > A + h$  the function  $f$  satisfies

$$f(R) \geq f(A) \left( (p-1)C(1+R-h)^{\epsilon-2}h^2 + 1 \right)^{\frac{R-A}{h}-1}.$$



If  $0 < \epsilon < 2$  we can take  $h = R^{1-\frac{\epsilon}{2}} \sqrt{\frac{e-1}{(p-1)C}}$ , obtaining

$$\begin{aligned} f(R) &\geq f(A) \left( (p-1)C \frac{h^2}{(1+R-h)^{2-\epsilon}} + 1 \right)^{\frac{R-A}{h}-1} \\ &\geq f(A) \left( (p-1)C \frac{h^2}{(h+R-h)^{2-\epsilon}} + 1 \right)^{\frac{R-A}{h}-1} \\ &= f(A) \left( (p-1)C \frac{h^2}{R^{2-\epsilon}} + 1 \right)^{\frac{R-A}{h}-1} \\ &= f(A) e^{-\frac{A}{h}-1} e^{\frac{R}{h}} \\ &\geq \frac{f(A)e^{-1}}{2} e^{\theta R^{\frac{\epsilon}{2}}} \end{aligned}$$

for every  $R$  big enough so that

$$R > A + h, \quad h \geq 1 \quad \text{and} \quad e^{-\frac{A}{h}} \geq \frac{1}{2}.$$

Similarly, if  $\epsilon = 2$  we can choose  $h = \sqrt{\frac{e-1}{(p-1)C}}$ , in order to get

$$\begin{aligned} f(R) &\geq f(A) \left( (p-1)Ch^2 + 1 \right)^{\frac{R-A}{h}-1} \\ &= f(A) e^{-\theta A-1} e^{\theta R}. \end{aligned}$$

In both cases we obtain a contradiction to (4.2.2), implying that  $u^- = 0$  almost everywhere, i.e. the claim.  $\square$

**Remark 4.2.5.** In the paper [69] by L. Mari, M. Rigoli and A.G. Setti, using the viewpoint of maximum principles at infinity for the  $\varphi$ -Laplacian, the authors proved a general *a priori* estimate that, in our setting, reduces as follow.

**Theorem 4.2.6** ([69, Theorem B]). *Let  $(M, g)$  be a complete Riemannian manifold and  $\lambda \in C(M)$  be a positive function satisfying*

$$\lambda(x) \geq \frac{B}{r(x)^{2-\epsilon}} \quad \text{in } M \setminus B_{R_0}(o)$$

for some  $\epsilon \in (0, +\infty)$ ,  $B > 0$ ,  $R_0 > 0$  and  $o \in M$ .

Let  $\sigma \geq 0$  and  $u \in C^1(M)$  be a distributional solution to

$$-\Delta u + \lambda u \geq 0 \quad \text{in } M$$

so that either  $u^-(x) = o(r(x)^\sigma)$  as  $r(x) \rightarrow +\infty$ , if  $\sigma > 0$ , or  $u$  is bounded from below, if  $\sigma = 0$ . Lastly, assume

$$\liminf_{r \rightarrow +\infty} \frac{\ln |B_r(o)|}{r^{\epsilon-\sigma}} < +\infty \quad \text{if } \sigma < \epsilon$$

or

$$\liminf_{r \rightarrow +\infty} \frac{\ln |B_r(o)|}{\ln r} < +\infty \quad \text{if } \sigma = \epsilon.$$

Then,  $u \geq 0$ .

This result compares with our Theorem 4.2.2. Indeed, on the one hand, if we assume the pointwise control  $u^-(x) = o(r^\sigma(x))$ , for  $0 < \sigma < \epsilon$ , condition (4.2.2) is satisfied provided  $|B_R| = O(R^{-p\sigma} e^{\theta R^{\frac{\epsilon}{2}}})$ ,  $p \in (1, +\infty)$ , while Theorem 4.2.6 requires the volume growth  $|B_R| = O(e^{R^{\epsilon-\sigma}})$ .

On the other hand, our Theorem 4.2.2 improves Theorem 4.2.6 in two aspects. First of all, we require less regularity on the functions  $u$  and  $\lambda$ . Indeed, we only need  $L_{loc}^p$  solutions with  $L_{loc}^\infty$  potentials in order to use the Brezis-Kato inequality and the regularity result claimed in Section 4.1. Secondly, we only need an  $L^p$ -bound on the asymptotic growth of  $u^-$ , instead of a pointwise asymptotic control. This allows us to consider a wider class of functions, for example having a super-quadratic growth, even in the case  $\epsilon < 2$ .

In the particular case where  $\epsilon = 2$ , for instance when  $\lambda$  is a constant, we get the next version of Theorem 4.2.2.

**Corollary 4.2.7.** *Let  $(M, g)$  be a complete Riemannian manifold,  $\lambda \in L_{loc}^\infty(M)$  so that  $\lambda \geq C$  for a positive constant  $C$  and  $p \in (1, +\infty)$ .*

*If  $u \in L_{loc}^p(M)$  satisfies  $-\Delta u + \lambda u \geq 0$  in the sense of distributions and*

$$\int_{B_R} (u^-)^p \, dv = o(e^{\theta R}) \quad \text{as } R \rightarrow +\infty \quad (4.2.4)$$

*with  $\theta = \sqrt{\frac{(p-1)C}{e-1}}$ , then  $u \geq 0$  in  $M$ .*

**Remark 4.2.8.** Corollary 4.2.7 strongly improves one of the main results of [85] in the setting of complete manifolds. Indeed, in that paper, the  $L_{loc}^p$  positivity preservation is obtained under the condition  $\int_{B_R(o)} (u^-)^p \, dv = o(R^2)$ . See [85, Corollary 5.2 and Remark 5.3].

As a byproduct, by applying Corollary 4.2.7 to both the functions  $u$  and  $-u$ , we get an uniqueness statement for  $L_{loc}^p$  solutions to  $-\Delta u + \lambda u = 0$ .

**Corollary 4.2.9 (Uniqueness).** *Let  $(M, g)$  be a complete Riemannian manifold,  $\lambda \in L_{loc}^\infty(M)$  so that  $\lambda \geq C$  for a positive constant  $C$  and  $p \in (1, +\infty)$ .*

*If  $u \in L_{loc}^p(M)$  satisfies  $-\Delta u + \lambda u = 0$  in the sense of distributions and*

$$\int_{B_R} (u^\pm)^p \, dv = o(e^{\theta R}) \quad \text{as } R \rightarrow +\infty$$

*with  $\theta = \sqrt{\frac{(p-1)\lambda}{e-1}}$ , then  $u = 0$  almost everywhere in  $M$ .*

**Remark 4.2.10.** As already observed at the beginning of this section, for every  $\lambda > 0$  the function  $u(x) = -e^{\sqrt{\lambda}x}$  provides a counterexample to the  $L^p_{loc}(\mathbb{R})$  positivity preserving property, for any  $p \in (1, +\infty)$ . Moreover, we stress that its  $p$ -norm has the following asymptotic growth

$$\int_{-R}^R (u^-)^p(x) \, dx = O(e^{p\sqrt{\lambda}R})$$

with  $p\sqrt{\lambda} > \sqrt{\frac{(p-1)\lambda}{e-1}}$ . Therefore, Theorem 4.2.2 and Corollary 4.2.7 are not far from being sharp. It would be very interesting to understand to what extent this exponent can be refined.

### 4.3 $L^1_{loc}$ positivity preserving property

The approach used in Section 4.2, which is based on inequality (4.1.1), is clearly not applicable for  $p = 1$ . To overcome this problem, we resort to some special cut-off to be used as test functions in the distributional inequality satisfied by  $u$ . The existence of these functions is ensured, for instance, by requiring certain conditions on the decay of the Ricci curvature.

#### 4.3.1 Cut-off functions with decaying laplacians

The first theorem we present in this section is based on the following iterative lemma. It is an analogue of the Lemma 4.2.1 for the case  $p = 1$ .

**Lemma 4.3.1.** *Let  $A > 0$  and  $f : [A, +\infty) \rightarrow (0, +\infty)$  be a nondecreasing function. Suppose there exist  $\sigma > 1, \gamma > 0, \alpha > 0$  and  $\beta \geq 1$  so that*

$$f(r) \leq \frac{1}{\alpha r^\gamma + \beta} f(\sigma r) \tag{4.3.1}$$

for every  $r \geq A$ . Then,  $f$  satisfies

$$f(R) \geq \left(\frac{R}{A}\right)^{\log_\sigma(\alpha A^\gamma + \beta)} \frac{f(A)}{\alpha A^\gamma + \beta}$$

for every  $R > A$ .

*Proof.* Having fixed  $R \geq A$ , we have

$$\begin{aligned} f(R) &\leq (\alpha R^\gamma + \beta)^{-1} f(\sigma R) \\ &\leq (\alpha R^\gamma + \beta)^{-1} (\alpha (\sigma R)^\gamma + \beta)^{-1} f(\sigma^2 R) \\ &\leq (\alpha R^\gamma + \beta)^{-2} f(\sigma^2 R) \end{aligned}$$

and, iterating,

$$f(R) \leq (\alpha R^\gamma + \beta)^{-n} f(\sigma^n R)$$

for every  $n \in \mathbb{N}$ .

Now consider  $n \in \mathbb{N}$  so that  $\sigma^{n+1}A \geq R \geq \sigma^n A$ . In particular, from

$$\sigma^{n+1}A \geq R \quad \Rightarrow \quad n \geq \log_\sigma \left( \frac{R}{A} \right) - 1$$

we deduce

$$\begin{aligned} f(R) &\geq f(\sigma^n A) \geq (\alpha A^\gamma + \beta)^n f(A) \\ &\geq (\alpha A^\gamma + \beta)^{\log_\sigma(\frac{R}{A})} \frac{f(A)}{\alpha A^\gamma + \beta} \\ &= \left( \frac{R}{A} \right)^{\log_\sigma(\alpha A^\gamma + \beta)} \frac{f(A)}{\alpha A^\gamma + \beta} \end{aligned}$$

as claimed □

As a consequence, by requiring the existence of a family  $\{\phi_R\}_R$  of cut-off functions whose laplacians decay as  $|\Delta\phi_R| \leq CR^{-\gamma}$  for a positive constant  $\gamma$ , we get

**Theorem 4.3.2** (Generalized  $L^1_{loc}$  positivity preserving property). *Let  $(M, g)$  be a complete Riemannian manifold and  $\lambda$  a positive constant. Assume that for a fixed  $o \in M$  there exist some positive constants  $\gamma$  and  $R_0$  and a constant  $\sigma > 1$  satisfying the following condition: for every  $R > R_0$  there exists  $\phi_R \in C_c^2(M)$  such that*

$$\begin{cases} 0 \leq \phi_R \leq 1 & \text{in } M \\ \phi_R \equiv 1 & \text{in } B_R(o) \\ \text{supp}(\phi_R) \subset B_{\sigma R}(o) & \\ |\Delta\phi_R| \leq \frac{C}{R^\gamma} & \text{in } M \end{cases} \quad (4.3.2)$$

where  $C = C(\sigma) > 0$  is a constant not depending on  $R$ .

If  $u \in L^1_{loc}(M)$  satisfies  $-\Delta u + \lambda u \geq 0$  in the sense of distributions and there exists  $k \in \mathbb{N}$  so that

$$\int_{B_R(o)} u^- \, dv = O(R^k) \quad \text{as } R \rightarrow +\infty, \quad (4.3.3)$$

then  $u \geq 0$  almost everywhere in  $M$ .

*Proof.* Fix  $u \in L^1_{loc}(M)$  a distributional solution to  $-\Delta u + \lambda u \geq 0$  that satisfies condition (4.3.3) for a certain  $k \in \mathbb{N}$ . By Brezis-Kato inequality  $\Delta u^- \geq \lambda u^-$  in the sense of distributions, implying

$$\lambda \int_M u^- \phi_R \, dv \leq \int_M u^- \Delta \phi_R \, dv \quad \forall R > R_0.$$

Using the definition of  $\phi_R$ , we get

$$\lambda \int_{B_R(o)} u^- \phi_R \, dv \leq \frac{C}{R^\gamma} \int_{B_{\sigma R}(o) \setminus B_R(o)} u^- \, dv \quad \forall R > R_0$$

and, by adding

$$\frac{C}{R^\gamma} \int_{B_R(o)} u^- \, dv$$

to both sides of the previous inequality, we obtain

$$\begin{aligned} \int_{B_R(o)} u^- \, dv &\leq \frac{C}{\lambda R^\gamma + C} \int_{B_{\sigma R}(o)} u^- \, dv \\ &= \frac{1}{\alpha R^\gamma + 1} \int_{B_{\sigma R}(o)} u^- \, dv \quad \forall R > R_0, \end{aligned} \tag{4.3.4}$$

where  $\alpha = \frac{\lambda}{C}$  depends on  $\sigma$ . Similarly to what we done in Theorem 4.2.2, if we suppose that  $u^- \neq 0$  almost everywhere in  $M$ , then there exists  $A \geq R_0$  so that

$$\int_{B_A(o)} u^- \, dv > 0.$$

By (4.3.4) we can apply Lemma 4.3.1 to the function  $f : [A, +\infty) \rightarrow \mathbb{R}_{>0}$  given by

$$f : r \mapsto \int_{B_r(o)} u^- \, dv$$

with  $\beta = 1$ , and we get

$$f(R) \geq \left(\frac{R}{A}\right)^{\log_\sigma(\alpha A^\gamma + 1)} \frac{f(A)}{\alpha A^\gamma + 1}$$

for every  $R > A$ . Choosing  $A \geq R_0$  big enough so that

$$\log_\sigma(\alpha A^\gamma + 1) \geq k + 1$$

we have

$$f(R) \geq \left(\frac{R}{A}\right)^{k+1} \frac{f(A)}{\alpha A^\gamma + 1}$$

for every  $R > A$ , thus obtaining a contradiction to (4.3.3). Hence  $u^- = 0$  almost everywhere, implying the claim.  $\square$

As showed by D. Bianchi and A.G. Setti in [15, Corollary 2.3], a sufficient condition for the existence of a family  $\{\phi_R\}_R$  satisfying (4.3.2) is a sub-quadratic decay of the Ricci curvature. Whence, we get the following corollary.

**Corollary 4.3.3.** *Let  $(M, g)$  be a complete Riemannian manifold of dimension  $m$  and  $\lambda$  a positive constant. Consider  $o \in M$  and assume that*

$$\text{Ric}_g \geq -(m-1)C^2(1+r^2)^\eta,$$

where  $C$  is a positive constant,  $\eta \in [-1, 1)$  and  $r(x) := d(x, o)$  is the intrinsic distance from  $o$  in  $M$ . If  $u \in L^1_{loc}(M)$  satisfies  $-\Delta u + \lambda u \geq 0$  in the sense of distributions and, for some  $k \in \mathbb{N}$ ,

$$\int_{B_R(o)} u^- \, dv = O(R^k) \quad \text{as } R \rightarrow +\infty,$$

then  $u \geq 0$  almost everywhere in  $M$ .

### 4.3.2 Cut-off functions with equibounded laplacians

The second theorem of this section is an  $L_{loc}^1$  positivity preserving property based on the existence of a family of cut-off functions with equibounded laplacians. The structure of the proof is very similar to the one adopted for Theorem 4.3.2 and it makes use of the following iterative lemma.

**Lemma 4.3.4.** *Let  $A > 0$  and  $f : [A, +\infty) \rightarrow (0, +\infty)$  be a nondecreasing function. Suppose there exist  $\alpha > 1$  and  $\sigma > 1$  so that*

$$f(r) \leq \frac{1}{\alpha} f(\sigma r) \quad (4.3.5)$$

for every  $r \geq A$ . Then,  $f$  satisfies

$$f(R) \geq f(A) \left( \frac{R}{A\sigma} \right)^\theta$$

for every  $R > A$ , where  $\theta = \frac{\ln(\alpha)}{\ln(\sigma)} > 0$ .

*Proof.* Iterating (4.3.5), for every  $n \in \mathbb{N}$  we get

$$f(r) \leq \frac{1}{\alpha^n} f(\sigma^n r)$$

for any  $r \geq A$ . It follows that for any  $R > A$

$$f(R) \geq f(A\sigma^n) \geq \alpha^n f(A) \geq \alpha^{\log_\sigma(\frac{R}{A\sigma})} f(A) = f(A) \left( \frac{R}{A\sigma} \right)^{\frac{\ln(\alpha)}{\ln(\sigma)}},$$

where  $n = n(R, A, \sigma)$  is the unique natural number satisfying  $\sigma^{n+1} \geq \frac{R}{A} \geq \sigma^n$ . This concludes the proof.  $\square$

We can now state our second main theorem that involves functions with an  $L^1$ -controlled growth.

**Theorem 4.3.5** (Generalized  $L_{loc}^1$  positivity preserving property). *Let  $(M, g)$  be a complete Riemannian manifold and  $\lambda$  a positive constant. Assume that for a fixed  $o \in M$  there exist some positive constants  $C$  and  $R_0$  and a constant  $\sigma > 1$  satisfying the following condition: for every  $R > R_0$  there exists  $\phi_R \in C_c^2(M)$  such that*

$$\begin{cases} 0 \leq \phi_R \leq 1 & \text{in } M \\ \phi_R \equiv 1 & \text{in } B_R(o) \\ \text{supp}(\phi_R) \subset B_{\sigma R}(o) & \\ |\Delta \phi_R| \leq C & \text{in } M. \end{cases} \quad (4.3.6)$$

If  $u \in L_{loc}^1(M)$  satisfies  $-\Delta u + \lambda u \geq 0$  in the sense of distributions and

$$\int_{B_R(o)} u^- \, dv = o(R^\theta) \quad \text{as } R \rightarrow +\infty \quad (4.3.7)$$

with  $\theta = \frac{\ln(1+\frac{\lambda}{C})}{\ln(\sigma)}$ , then  $u \geq 0$  almost everywhere in  $M$ .

*Proof.* As in the proof of Theorem 4.3.2, we get

$$\lambda \int_M u^- \phi_R \, dv \leq \int_M u^- \Delta \phi_R \quad \forall R > R_0$$

that implies

$$\int_{B_R(o)} u^- \, dv \leq \frac{C}{\lambda + C} \int_{B_{\sigma R}(o)} u^- \, dv \quad \forall R > R_0. \quad (4.3.8)$$

If  $u^- \neq 0$  almost everywhere in  $M$ , then there exists  $A > 0$  such that

$$\int_{B_A(o)} u^- \, dv > 0.$$

By (4.3.8) we can apply Lemma 4.3.4 with

$$f : r \mapsto \int_{B_r(o)} u^- \, dv$$

and  $\alpha = \frac{C+\lambda}{C}$  and we deduce that  $f(R) \geq C_0 R^{\frac{\ln(\alpha)}{\ln(\sigma)}}$  for every  $R > A$ , where  $C_0 > 0$ . This contradicts (4.3.7). Hence  $u^- = 0$  almost everywhere in  $M$ , as required.  $\square$

In the proof of [61, Corollary 4.1], the authors obtained a family of cutoff functions satisfying (4.3.6) under the only assumption of a lower bound on the Ricci curvature. As a consequence, we obtain the following

**Corollary 4.3.6.** *Let  $(M, g)$  be a complete Riemannian manifold and  $\lambda$  a positive constant. Consider  $o \in M$  and assume that*

$$\text{Ric}_g(x) \geq -G^2(r(x))$$

for every  $x \in M \setminus B_R(o)$ , where  $r(x) = d(x, o)$  and  $G \in C^\infty$  is given by

$$G(t) = \alpha t \prod_{0 \leq j \leq k} \ln^{[j]}(t)$$

for  $t > 1$ ,  $\alpha > 0$  and  $k \in \mathbb{N}$ .

Then, there exists a constant  $\theta = \theta(\lambda, M, \alpha, k) > 0$  such that if  $u \in L^1_{loc}(M)$  satisfies  $-\Delta u + \lambda u \geq 0$  in the sense of distributions and

$$\int_{B_R(o)} u^- \, dv = o(R^\theta) \quad \text{as } R \rightarrow +\infty,$$

then  $u \geq 0$  almost everywhere in  $M$ . In particular, the positivity preserving property holds true in the family of functions

$$\{u \in L^1_{loc}(M) : u^- \in L^1(M)\}.$$

**Remark 4.3.7.** In Theorem 3.3.1, we constructed a counterexample to the  $L^1$  positivity preserving property in a complete 2-manifold having Gaussian curvature with an asymptotic of the form  $K(x) \sim -Cr(x)^{2+\epsilon}$ , for  $\epsilon > 0$ . This underlines that the result contained in Corollary 4.3.6 is sharp.

**Remark 4.3.8.** When stated in terms of a Liouville type property, our Corollary 4.3.6 compares e.g. with [95, Theorem C], where the authors consider the case  $\lambda = 0$  of subharmonic functions. Their result states that a  $C^1$ , nonnegative subharmonic function with precise pointwise exponential control and a logarithmic  $L^1$  growth must be constant. They also provide a rotationally symmetric example  $(M, g)$  with Gaussian curvature  $K(x) \sim -Cr(x)^2$  showing that, without the pointwise control, there exists an unbounded smooth solution to  $\Delta u = 1$  of logarithmic  $L^1$ -growth. As a consequence, keeping the curvature restriction of Corollary 4.3.6, in order to obtain the Liouville result under a pure  $L^1$ -growth condition, which is even faster than logarithmic, one has to assume that  $\lambda > 0$ .

## 4.4 An application to minimal submanifolds

Recall that an immersed submanifold  $x : \Sigma^n \hookrightarrow \mathbb{R}^m$  is said to be minimal if its mean curvature vector field satisfies  $H_\Sigma = 0$ . It is a standard fact that the minimality condition is equivalent to the property that the coordinate functions of the isometric immersion are harmonic, i.e.,

$$\Delta^\Sigma x_i = 0 \quad \forall i = 1, \dots, m.$$

Indeed, if  $(y_1, \dots, y_n)$  are local coordinates in  $p \in \Sigma$ , let  $\{E_1, \dots, E_n\}$  be a local orthonormal frame tangential to  $x(\Sigma)$  around  $x(p)$  so that

$$E_i|_{x(p)} = dx_p \frac{\partial}{\partial y_i}$$

and extend it to an orthonormal frame  $\{E_1, \dots, E_m\}$  around  $x(p)$  in  $\mathbb{R}^m$ , where  $\{E_{n+1}, \dots, E_m\}$  is the (local) frame normal to  $x(\Sigma)$  around  $x(p)$ . It follows that for any smooth function  $f$  over  $\mathbb{R}^m$  we have

$$\begin{aligned} \Delta^{\mathbb{R}^m} f &= \sum_{i=1}^m \langle \nabla_{E_i} \nabla f, E_i \rangle \\ &= \sum_{i=1}^n [E_i(E_i(f)) - (\nabla_{E_i} E_i)(f)] + \sum_{j=n+1}^m \langle \nabla_{E_j} \nabla f, E_j \rangle \\ &= \sum_{i=1}^n [E_i(E_i(f)) - (\nabla_{E_i} E_i)^\top(f) - (\nabla_{E_i} E_i)^\perp(f)] + \sum_{j=n+1}^m \langle \nabla_{E_j} \nabla f, E_j \rangle \\ &= \Delta^\Sigma f - H_\Sigma(f) + \sum_{j=n+1}^m \langle \nabla_{E_j} \nabla f, E_j \rangle. \end{aligned}$$



By the fact that  $\Sigma$  is minimal it follows that

$$\begin{aligned}\Delta^\Sigma f &= \Delta^{\mathbb{R}^m} f - \sum_{j=n+1}^m \langle \nabla_{E_j} \nabla f, E_j \rangle \\ &= \sum_{i=1}^n \langle \nabla_{E_i} \nabla f, E_i \rangle.\end{aligned}$$

As a consequence, the immersion has harmonic coordinates

$$\Delta^\Sigma x_i = 0 \quad \forall i = 1, \dots, m.$$

This implies that for any minimal submanifold in Euclidean space,

$$\Delta^\Sigma |x|^2 = 2n.$$

As an application of the main results in Section 4.2, we prove that complete minimal submanifold enjoy the following  $L^p$  extrinsic distance growth condition.

**Corollary 4.4.1.** *Let  $x : \Sigma \hookrightarrow \mathbb{R}^m$  be a complete minimal submanifold and suppose there exists a positive function  $\xi : \mathbb{R}_{\geq 0} \rightarrow \mathbb{R}_{> 0}$  such that*

$$(d^{\mathbb{R}^m}(x, o))^2 \leq \xi(d^\Sigma(x, o)) \quad \text{and} \quad \xi(R) = O(R^{2-\epsilon}), \text{ as } R \rightarrow +\infty$$

for some constants  $C > 0$  and  $\epsilon \in (0, 2]$  and for some fixed origin  $o \in \Sigma$ . Then, for every  $p \in (1, +\infty)$ ,

$$\limsup_{R \rightarrow +\infty} \frac{\int_{B_R^\Sigma(o)} \xi^p \, dv_\Sigma}{e^{\theta R^{\frac{\epsilon}{2}}}} > 0, \quad (4.4.1)$$

where  $\theta = \sqrt{\frac{(p-1)C}{e-1}}$ .

*Proof.* Without loss of generality we can suppose  $o = 0 \in \mathbb{R}^m$ . Let

$$w(x) := d^{\mathbb{R}^m}(x, o) = |x|^2$$

and define

$$\lambda(x) := \frac{2n}{\xi(d^\Sigma(x, o))}.$$

Then

$$\Delta^\Sigma w = 2n = \lambda \xi \geq \lambda w.$$

By contradiction, suppose that (4.4.1) is not satisfied for some  $p \in (1, +\infty)$ . Then

$$0 = \limsup_{R \rightarrow +\infty} \frac{\int_{B_R^\Sigma(o)} \xi^p \, dv_\Sigma}{e^{\theta R^{\frac{\epsilon}{2}}}} \geq \limsup_{R \rightarrow +\infty} \frac{\int_{B_R^\Sigma(o)} w^p \, dv_\Sigma}{e^{\theta R^{\frac{\epsilon}{2}}}} \geq 0,$$

showing that

$$\int_{B_R^\Sigma(o)} w^p \, dv_\Sigma = o(e^{\theta R^{\frac{\epsilon}{2}}}), \quad R \rightarrow +\infty.$$

An application of Theorem 4.2.2, in the form of a Liouville type result, yields that  $w \equiv 0$ . Contradiction.  $\square$

**Remark 4.4.2.** In the assumption of Corollary 4.4.1 we get an asymptotic estimate on the behavior of  $|B_R^\Sigma|$ . Indeed, since there exist two constants  $C > 0$  and  $\epsilon \in (0, 2]$  such that

$$\xi(x) \leq C \left(1 + d^\Sigma(x, o)\right)^{2-\epsilon},$$

then

$$\int_{B_R^\Sigma(o)} \xi^p \, dv \leq C \int_{B_R^\Sigma(o)} (1 + d^\Sigma(x, o))^{(2-\epsilon)p} \, dv \leq C(1 + R)^{(2-\epsilon)p} |B_R^\Sigma(o)|.$$

By (4.4.1) it follows

$$\limsup_{R \rightarrow +\infty} \frac{(1 + R)^{(2-\epsilon)p} |B_R^\Sigma(o)|}{e^{\theta R^{\frac{\epsilon}{2}}}} > 0.$$

Whence, we obtain the validity of the following nonexistence result.

**Corollary 4.4.3.** *There are no complete minimal submanifolds  $\Sigma^n \hookrightarrow \mathbb{R}^m$  satisfying the following conditions:*

a) *the extrinsic distance from a fixed origin  $o \in \Sigma$  satisfies*

$$\left(d^{\mathbb{R}^m}(x, o)\right)^2 \leq \xi(d^\Sigma(x, o))$$

*with*

$$\xi(R) = O(R^{2-\epsilon}) \quad \text{as } R \rightarrow +\infty$$

*for some  $\epsilon \in (0, 2]$ ;*

b) *the intrinsic geodesic balls of  $\Sigma$  centered at  $o$  satisfy the asymptotic estimate*

$$|B_R^\Sigma(o)| = o\left(R^{-(2-\epsilon)p} e^{\theta R^{\frac{\epsilon}{2}}}\right) \quad \text{as } R \rightarrow +\infty,$$

*with  $\theta = \sqrt{\frac{(p-1)C}{e-1}}$  and  $p \in (1, +\infty)$ .*

**Remark 4.4.4.** We stress that in case  $\epsilon = 2$ , i.e. for bounded minimal submanifolds, the volume growth we obtained is far from being optimal. Indeed, in [63] and [82] the authors achieved the rate  $|B_R^\Sigma(o)| = O(e^{CR^2})$ . This discrepancy comes from the fact that we use integral techniques and estimates.

---

## $L^p$ positivity preservation and self-adjointness on incomplete Riemannian manifolds <sup>1</sup>

---

In this chapter we see how the techniques presented so far allow us to recover the preservation of positivity for the operator  $-\Delta + V$  also in incomplete Riemannian manifolds. From the viewpoint of potential theory, the completeness of the manifold is replaced by a Minkowski-type condition and by a control on the (local) growth of the potential. Once obtained the positivity preservation, we show how this spectral property is sufficient to show that for any  $p \in (1, +\infty)$  the family  $C_c^\infty$  is an operator core for the  $p$ -maximal operator associated to  $-\Delta + V$ .

### 5.1 $L^p$ positivity preservation

This section is aimed to prove the following

**Theorem 5.1.1.** *Let  $(N, h)$  be a complete Riemannian manifold and define  $M := N \setminus K$ , where  $K \subset N$  is a compact subset. Consider  $V \in L_{loc}^\infty(M)$  so that*

$$V(x) \geq \frac{C}{r^m(x)} \quad \text{in } M,$$

where  $C \in [0, 1]$  and  $m \in \{0, 2\}$  are positive constants and  $r(x) := d^N(x, K)$  is the distance function from  $K$ , and fix  $p \in (1, +\infty)$ .

If there exist two positive constants  $E \geq 1$  and

$$h \geq \begin{cases} 0 & \text{if } m = 2 \text{ and } C = \frac{1}{p-1} \\ \frac{p+p\sqrt{1-(p-1)C}}{p-1} & \text{if } m = 2 \text{ and } C \in \left(0, \frac{1}{p-1}\right) \\ \frac{2p}{p-1} & \text{if } m = 0 \end{cases} \quad (5.1.1)$$

---

<sup>1</sup>The content of this chapter is based on [20], a joint work with Prof. Giona Veronelli.

so that

$$|B_r(K)| \leq Er^h \quad \text{as } r \rightarrow 0, \quad (5.1.2)$$

then the differential operator  $-\Delta + V$  has the  $L^p$  positivity preserving property.

**Remark 5.1.2.** Reasoning as in [85, Section 5], it is easy to see that Theorem 5.1.1, and consequently Theorems 5.2.2 and 5.3.15, holds as well if  $N$  is assumed to be  $q$ -parabolic for some  $q \geq \frac{2p}{p-1}$ , but not necessarily complete.

**Remark 5.1.3.** As explained in the introduction, the case  $m = 0$  recovers a result obtained in [85].

### 5.1.1 Preliminary results

In order to prove Theorem 5.1.1 we need two fundamental tools. The first is the classical Brezis-Kato inequality. We refer to [23, 88] for the Euclidean result and to [87, 85] for the Riemannian version.

**Proposition 5.1.4** (Brezis-Kato inequality). *Let  $(M, g)$  be a Riemannian manifold and  $V$  a measurable function over  $M$ .*

*If  $u \in L^1_{loc}(M)$  is so that  $Vu \in L^1_{loc}(M)$  and satisfies  $(-\Delta + V)u \leq 0$  in the sense of distributions, then*

$$(-\Delta + V)u^+ \leq 0 \quad \text{in the sense of distributions,}$$

where  $u^+(x) := \max\{u(x), 0\}$ .

The second ingredient is the regularity result of Proposition 4.1.2. Initially stated for complete Riemannian manifolds, we stress that its original proof recovers in fact also the case of incomplete Riemannian manifolds. Before stating this result, we recall that the negative part of a real-valued function, denoted with  $u^-$ , is defined as

$$u^-(x) := \max\{-u, 0\} = (-u)^+(x).$$

Using the above notation, the mentioned regularity result states what follows.

**Proposition 5.1.5.** *Let  $(M, g)$  be a (possibly incomplete) Riemannian manifold and  $0 \leq V \in L^\infty_{loc}(M)$ .*

*If  $u \in L^1_{loc}(M)$  satisfies  $(-\Delta + V)u \geq 0$  in the sense of distributions, then*

(1)  $u^- \in L^\infty_{loc}(M)$  and  $(u^-)^{p/2} \in W^{1,2}_{loc}(M)$  for every  $p \in (1, +\infty)$ ;

(2) for every  $p \in (1, +\infty)$  the function  $u^-$  satisfies

$$(p-1) \int_M V(u^-)^p \varphi^2 \, dv \leq \int_M (u^-)^p |\nabla \varphi|^2 \, dv \quad (5.1.3)$$

for every  $0 \leq \varphi \in C_c^{0,1}(M)$ .

### 5.1.2 Positivity preserving

In the next we proceed with the proof of the positivity preserving property contained in Theorem 5.1.1, which is completely based on the inequality (5.1.3). To this aim, let  $R > \epsilon > 2\eta > 0$  and  $\delta > 0$  and consider the following real function  $\psi : \mathbb{R}_{\geq 0} \rightarrow \mathbb{R}_{\geq 0}$

$$\psi_{R,\epsilon,\eta}(t) := \begin{cases} 0 & \text{in } [0, \eta) \\ \frac{t-\eta}{\eta} \left(\frac{2\eta}{\epsilon}\right)^\delta & \text{in } [\eta, 2\eta) \\ \left(\frac{t}{\epsilon}\right)^\delta & \text{in } [2\eta, \epsilon) \\ 1 & \text{in } [\epsilon, R) \\ \frac{R+\eta-t}{\eta} & \text{in } [R, R+\eta) \\ 0 & \text{in } [R+\eta, +\infty). \end{cases}$$

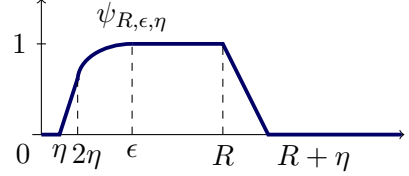

Let  $(N, g)$  be a complete Riemannian manifold and define  $M := N \setminus K$ , where  $K \subset N$  is a compact subset. Denote with  $r(x) := d^N(x, K)$  the distance function from  $K$  and consider the following cut-off function

$$\varphi_{R,\epsilon,\eta} := (\psi_{R,\epsilon,\eta} \circ r) \in C_c^{0,1}(M).$$

In particular,  $\varphi_{R,\epsilon,\eta}$  can be extended to 0 in  $K$ , obtaining  $\varphi_{R,\epsilon,\eta} \in C_c^{0,1}(N)$ .

As a consequence, we can finally obtain the proof of the  $L^p$  positivity preserving property.

*Proof of Theorem 5.1.1.* Let  $v \in L^p$  be a solution to  $(-\Delta + V)v \geq 0$  and denote  $u := v^- \geq 0$ . Fix  $\delta > 0$  and for  $0 \leq 2\eta < \epsilon < R$  consider the function  $\varphi_{R,\epsilon,\eta}$ .

**Step 1.** We start by supposing that  $v$  is compactly supported in  $N$ . Fix  $s \in (1, p]$ . By applying (5.1.3) to the test functions  $\varphi_{R,\epsilon,\eta}$ , we get

$$(s-1) \int_M u^s V \varphi_{R,\epsilon,\eta}^2 \, dv \leq \int_M u^s |\nabla \varphi_{R,\epsilon,\eta}|^2 \, dv.$$

On the one hand, we have

$$\begin{aligned} (s-1) \int_M u^s V \varphi_{R,\epsilon,\eta}^2 \, dv \\ \geq (s-1) \int_{B_\epsilon \setminus B_{2\eta}} u^s \frac{C}{r^m} \left(\frac{r}{\epsilon}\right)^{2\delta} \, dv + (s-1) \int_{B_R \setminus B_\epsilon} u^s V \, dv \end{aligned}$$

while, on the other hand, choosing  $R$  big enough so that the support of  $u$  is contained in  $B_R$ ,

$$\int_M u^s |\nabla \varphi_{R,\epsilon,\eta}|^2 \, dv \leq \int_{B_{2\eta} \setminus B_\eta} u^s \frac{1}{\eta^2} \left(\frac{2\eta}{\epsilon}\right)^{2\delta} \, dv + \int_{B_\epsilon \setminus B_{2\eta}} u^s \delta^2 \frac{r^{2\delta-2}}{\epsilon^{2\delta}} \, dv.$$

By putting together previous inequalities, we obtain

$$\begin{aligned}
& (s-1) \int_{B_R \setminus B_\epsilon} u^s V \, dv \\
& \leq \int_{B_{2\eta} \setminus B_\eta} u^s \frac{1}{\eta^2} \left( \frac{2\eta}{\epsilon} \right)^{2\delta} \, dv \\
& \quad + \int_{B_\epsilon \setminus B_{2\eta}} u^s \delta^2 \frac{r^{2\delta-2}}{\epsilon^{2\delta}} \, dv - (s-1) \int_{B_\epsilon \setminus B_{2\eta}} u^s \frac{C}{r^m} \left( \frac{r}{\epsilon} \right)^{2\delta} \, dv \\
& = \int_{B_{2\eta} \setminus B_\eta} u^s \frac{1}{\eta^2} \left( \frac{2\eta}{\epsilon} \right)^{2\delta} \, dv + \int_{B_\epsilon \setminus B_{2\eta}} u^s \frac{r^{2\delta-2}}{\epsilon^{2\delta}} \left[ \delta^2 - C(s-1)r^{2-m} \right] \, dv \\
& \leq \int_{B_{2\eta}} u^s \frac{1}{\eta^2} \left( \frac{2\eta}{\epsilon} \right)^{2\delta} \, dv + \left[ \delta^2 - C(s-1)(2\eta)^{2-m} \right] \int_{B_\epsilon \setminus B_{2\eta}} u^s \frac{r^{2\delta-2}}{\epsilon^{2\delta}} \, dv \\
& \stackrel{\text{H\"older}}{\leq} 4\epsilon^{-2\delta} E^{\frac{p-s}{p}} (2\eta)^{h\frac{p-s}{p}+2\delta-2} \left( \int_{B_{2\eta}} u^p \, dv \right)^{\frac{s}{p}} \\
& \quad + \left[ \delta^2 - (s-1)C(2\eta)^{2-m} \right] \int_{B_\epsilon \setminus B_{2\eta}} u^s \frac{r^{2\delta-2}}{\epsilon^{2\delta}} \, dv.
\end{aligned}$$

Hence, recalling that the support of  $u$  is contained in  $B_R$ ,

$$\begin{aligned}
(s-1) \int_{B_\epsilon^c} u^s V \, dv & \leq 4\epsilon^{-2\delta} E^{\frac{p-s}{p}} (2\eta)^{h\frac{p-s}{p}+2\delta-2} \left( \int_{B_{2\eta}} u^p \, dv \right)^{\frac{s}{p}} \\
& \quad + \left[ \delta^2 - (s-1)C(2\eta)^{2-m} \right] \int_{B_\epsilon \setminus B_{2\eta}} u^s \frac{r^{2\delta-2}}{\epsilon^{2\delta}} \, dv
\end{aligned} \tag{5.1.4}$$

for every  $s \in (1, p]$ . In our assumptions, we can choose  $\delta$  and  $s$  so that

$$\delta^2 - (s-1)C(2\eta)^{2-m} = 0 \tag{5.1.5}$$

and

$$h \frac{p-s}{p} + 2\delta - 2 \geq 0 \tag{5.1.6}$$

for every  $h$  satisfying (5.1.1). Indeed, following a case-by-case analysis:

- $m = 2$  and  $C = \frac{1}{p-1}$ : in this case we can just choose  $s = p$  and  $\delta = 1$ , so that (5.1.6) is trivially satisfied for every  $h \geq 0$ .
- $m = 2$  and  $C \in \left(0, \frac{1}{p-1}\right)$ : in this case we choose  $\delta = \frac{pC}{h}$  and  $s = 1 + \frac{\delta^2}{C}$ . Observing that

$$\begin{aligned}
h \frac{p-s}{p} + 2\delta - 2 \geq 0 & \Leftrightarrow h(p-s) + 2p\delta - 2p \geq 0 \\
& \Leftrightarrow h \left( p - 1 - \frac{\delta^2}{C} \right) + 2p\delta - 2p \geq 0 \\
& \Leftrightarrow h^2(p-1) - h2p + p^2C \geq 0,
\end{aligned}$$

by the fact that  $C < \frac{1}{p-1}$  it follows

$$\begin{aligned}\Delta &= 4p^2 - 4p^2(p-1)C \geq 0 \\ \Rightarrow h^2(p-1) - h2p + p^2C &\geq 0 \quad \forall h \geq \frac{p + p\sqrt{1 - (p-1)C}}{p-1} \\ \Rightarrow h\frac{p-s}{p} + 2\delta - 2 &\geq 0 \quad \forall h \geq \frac{p + p\sqrt{1 - (p-1)C}}{p-1},\end{aligned}$$

implying (5.1.6) when  $\eta$  is small enough,.

- $m = 0$ : we choose  $\delta = \frac{pC(2\eta)^2}{h}$  and  $s = 1 + \frac{\delta^2}{C(2\eta)^2}$ . As in previous case

$$\begin{aligned}h\frac{p-s}{p} + 2\delta - 2 \geq 0 &\Leftrightarrow h(p-s) + 2p\delta - 2p \geq 0 \\ &\Leftrightarrow h^2(p-1) - h2p + p^2C(2\eta)^2 \geq 0\end{aligned}$$

with

$$\Delta = 4p^2 - 4p^2(p-1)C(2\eta)^2.$$

Since we are interested in the limit as  $\eta \rightarrow 0$ , we get

$$h\frac{p-s}{p} + 2\delta - 2 \geq 0 \quad \forall h \geq \frac{2p}{p-1}$$

implying, again, (5.1.6).

From (5.1.5) and (5.1.6), the inequality (5.1.4) implies

$$0 \leq (s-1) \int_{B_\epsilon^c} u^s V \, dv \leq \left( \int_{B_{2\eta}} u^p \, dv \right)^{\frac{s}{p}} 4\epsilon^{-2\delta} E^{\frac{p-s}{p}} (2\eta)^{h\frac{p-s}{p} + 2\delta - 2} \xrightarrow{\eta \rightarrow 0} 0.$$

Since it holds for any fixed  $\epsilon > 0$ , we get

$$\int_M u^s V \, dv = 0$$

that, together with the fact that  $V > 0$  and  $u \geq 0$ , implies

$$u = v^- \equiv 0.$$

**Step 2.** Now consider the general case where  $v$  is not assumed to be compactly supported. Since  $u := v^- \in L_{loc}^\infty(M)$  by Proposition 5.1.5, it follows that  $\|u\|_{L^\infty(B_\epsilon \setminus B_{2\eta})} < +\infty$ . Consider the function

$$w := \begin{cases} \left( \|u\|_{L^\infty(B_\epsilon \setminus B_{2\eta})} - u \right)^- & \text{in } B_\epsilon \\ 0 & \text{in } B_\epsilon^c. \end{cases}$$

By Proposition 5.1.4

$$(-\Delta + V)v \geq 0 \quad \Rightarrow \quad (-\Delta + V)\left(\|u\|_{L^\infty(B_\epsilon \setminus B_{2\eta})} - u\right) \geq 0 \quad \Rightarrow \quad (-\Delta + V)(-w) \geq 0,$$

where the last inequality holds since  $\left(\|u\|_{L^\infty(B_\epsilon \setminus B_{2\eta})} - u\right) \geq 0$  in  $B_\epsilon \setminus B_{2\eta}$ . Since  $w \in L^p(M)$ , by Step 1

$$\|u\|_{L^\infty(B_\epsilon \setminus B_{2\eta})} \geq u \geq 0 \quad \text{in } B_\epsilon.$$

In particular,

$$u \in L^p(B_\epsilon) \cap L^\infty(B_\epsilon) \quad \Rightarrow \quad u \in L^q(B_\epsilon) \quad \forall q \geq p. \quad (5.1.7)$$

As a consequence, by Proposition 5.1.5 applied to the test function  $\varphi_{R,\epsilon,\eta}$ , for any  $s \in (1, p]$

$$\begin{aligned} (s-1) \int_M u^p V \varphi_{R,\epsilon,\eta}^2 \, dv &\leq (p-1) \int_M u^p V \varphi_{R,\epsilon,\eta}^2 \, dv \\ &\leq \int_M u^p |\nabla \varphi_{R,\epsilon,\eta}|^2 \, dv \\ &\leq \int_{B_{2\eta}} u^p \frac{1}{\eta^2} \left(\frac{2\eta}{\epsilon}\right)^{2\delta} \, dv + \delta^2 \int_{B_\epsilon \setminus B_{2\eta}} u^p \frac{r^{2\delta-2}}{\epsilon^{2\delta}} \, dv + \int_{B_{R+\eta} \setminus B_R} u^p \frac{1}{\eta^2} \, dv \end{aligned}$$

and as  $R \rightarrow +\infty$  we get

$$\begin{aligned} (s-1) \int_{B_\epsilon \setminus B_{2\eta}} u^p \frac{C}{r^m} \left(\frac{r}{\epsilon}\right)^{2\delta} \, dv + (s-1) \int_{B_\epsilon} u^p V \, dv \\ \leq \lim_{R \rightarrow +\infty} (s-1) \int_M u^p V \varphi_{R,\epsilon,\eta}^2 \, dv \\ \leq \int_{B_{2\eta}} u^p \frac{1}{\eta^2} \left(\frac{2\eta}{\epsilon}\right)^{2\delta} \, dv + \delta^2 \int_{B_\epsilon \setminus B_{2\eta}} u^p \frac{r^{2\delta-2}}{\epsilon^{2\delta}} \, dv \end{aligned}$$

which implies

$$\begin{aligned} (s-1) \int_{B_\epsilon} u^p V \, dv \\ \leq \int_{B_{2\eta}} u^p \frac{1}{\eta^2} \left(\frac{2\eta}{\epsilon}\right)^{2\delta} \, dv + \int_{B_\epsilon \setminus B_{2\eta}} u^p \frac{r^{2\delta-2}}{\epsilon^{2\delta}} \left[\delta^2 - C(s-1)r^{2-m}\right] \, dv \\ \leq \int_{B_{2\eta}} u^p \frac{1}{\eta^2} \left(\frac{2\eta}{\epsilon}\right)^{2\delta} \, dv + \left[\delta^2 - C(s-1)(2\eta)^{2-m}\right] \int_{B_\epsilon \setminus B_{2\eta}} u^p \frac{r^{2\delta-2}}{\epsilon^{2\delta}} \, dv. \end{aligned}$$

In particular, this is equivalent

$$\begin{aligned} (s-1) \int_{B_\epsilon} \left(u^{\frac{p}{s}}\right)^s V \, dv \\ \leq \int_{B_{2\eta}} \left(u^{\frac{p}{s}}\right)^s \frac{1}{\eta^2} \left(\frac{2\eta}{\epsilon}\right)^{2\delta} \, dv + \left[\delta^2 - C(s-1)(2\eta)^{2-m}\right] \int_{B_\epsilon \setminus B_{2\eta}} \left(u^{\frac{p}{s}}\right)^s \frac{r^{2\delta-2}}{\epsilon^{2\delta}} \, dv \end{aligned}$$



for any  $s \in (1, p]$ . Observing that  $0 \leq u^{\frac{p}{s}} \in L^p(B_\epsilon)$  thanks to (5.1.7), under the assumptions (5.1.2) and (5.1.1) we can apply the argument presented in previous step obtaining that  $u \equiv 0$  in  $B_\epsilon^c$ . By the arbitrariness of  $\epsilon > 0$ , we get  $u \equiv 0$  and so  $v$  is nonnegative.  $\square$

## 5.2 Essential self-adjointness

As mentioned above, the positivity preserving property arises naturally when one deals with the self-adjointness of unbounded operators. In particular, as we are going to see, as soon as the  $L^2$  positivity preserving property holds for a certain class of Schrödinger operators, then these operators turn out to be essentially self-adjoint.

### 5.2.1 Standard notions and results about self-adjointness

We recall some basic definitions about unbounded operators defined over Banach spaces. For further details, we refer to [65, 93, 94].

Let  $(B, \|\cdot\|_B)$  be a Banach space. An unbounded densely defined linear operator  $T : D(T) \subseteq B \rightarrow B$  is said to be

- *closed* if its graph  $\Gamma(T) := \{(\psi, T\psi) : \psi \in D(T)\}$  is closed in  $B \times B$ ;
- an *extension of the operator*  $T_1 : D(T_1) \subseteq B \rightarrow B$  if  $\Gamma(T_1) \subseteq \Gamma(T)$  (or equivalently if  $D(T_1) \subseteq D(T)$  and  $T\psi = T_1\psi$  for every  $\psi \in D(T_1)$ );
- *closable* if it has a closed extension. Its smallest closed extension, called *closure*, is denoted by  $\overline{T}$ . Whence,  $\overline{T}$  is the operator whose graph is the closure of the graph of  $T$ .

In the particular case when  $B$  is an Hilbert space with respect to the scalar product  $(\cdot, \cdot)_B$  and  $T : D(T) \subseteq B \rightarrow B$  is an unbounded linear operator over  $B$ , the *adjoint of  $T$* , denoted with  $T^*$ , is defined as the unbounded linear operator whose domain is

$$D(T^*) := \{v \in B : \exists w \in B \text{ s.t. } (Tu, v)_B = (u, w)_B \ \forall u \in D(T)\}$$

and whose action is given by  $T^*v = w$ . In particular, by definition

$$(Tu, v)_B = (u, T^*v)_B \quad \forall u \in D(T), v \in D(T^*).$$

The operator  $T$  is said to be

- *symmetric* if

$$(Tu, v)_B = (u, Tv)_B \quad \forall u, v \in D(T)$$

or, equivalently, if  $T \subseteq T^*$ ;

- *self-adjoint* if  $T = T^*$ , that is, if  $T$  is symmetric and  $D(T) = D(T^*)$ ;
- *essentially self-adjoint* if  $T$  is symmetric and its closure  $\overline{T}$  is self-adjoint.

**Remark 5.2.1.** We stress that

- by definition, the adjoint of an operator is a closed operator. In particular, if  $T$  is symmetric (resp. self-adjoint), then  $T$  is closable (resp. closed);
- by an abstract fact ([65, Theorem 5.29]),  $(T^*)^* = \overline{T}$ ;
- a symmetric operator  $T$  is essentially self-adjoint if and only if it has a unique self-adjoint extension (see [93, page 256]).

### 5.2.2 Essential self-adjointness of $-\Delta + V$

A first application of Theorem 5.1.1 to the theory of unbounded operators is the following result concerning the essential self-adjointness of  $-\Delta + V$ . The case  $m = 2$  and  $C = 1$  was previously obtained in [72] with a different approach, while the case  $m = 0$  is already contained in [85]. Here we recover with a unified point of view both sets of assumptions, as well as all the new intermediate case  $m = 2$  and  $C \in (0, 1)$ .

**Theorem 5.2.2.** *Let  $(N, h)$  be a complete Riemannian manifold and define  $M := N \setminus K$ , where  $K \subset N$  is a compact subset. Consider  $V \in L_{loc}^\infty(M)$  so that*

$$V(x) \geq \frac{C}{r^m(x)} - B \quad \text{in } M,$$

where  $C \in [0, 1]$ ,  $m \in \{0, 2\}$  and  $B$  are positive constants and  $r(x) := d^N(x, K)$  is the distance function from  $K$ .

If there exist two positive constants  $E \geq 1$  and

$$h \geq \begin{cases} 0 & \text{if } m = 2 \text{ and } C = 1 \\ 2 + 2\sqrt{1-C} & \text{if } m = 2 \text{ and } C \in (0, 1) \\ 4 & \text{if } m = 0 \end{cases} \quad (5.2.1)$$

so that

$$|B_r(K)| \leq Er^h \quad \text{as } r \rightarrow 0, \quad (5.2.2)$$

then the differential operator  $-\Delta + V : C_c^\infty(M) \subset L^2(M) \rightarrow L^2(M)$  is essentially self-adjoint.

It is a standard fact (see [94, Theorem X.26]) that a necessary and sufficient condition for the operator  $-\Delta + V$  to be essentially self-adjoint on the domain  $C_c^\infty(M)$  is that the unique solution  $u \in L^2$  to  $(-\Delta + V)u = 0$  is the constant null function.

*Proof.* Let  $\tilde{V} = V + B + 1 > 0$ . Consider  $u \in L^2$  a solution to  $(-\Delta + \tilde{V})u = 0$ : by Theorem 5.1.1 applied both to  $u$  and  $-u$  it follows that  $u = 0$ . This means that

$$(-\Delta + \tilde{V})u = 0 \quad \Rightarrow \quad u = 0$$

and hence  $(-\Delta + \tilde{V})$  is essentially self-adjoint on  $C_c^\infty(M)$ . By the invariance of the essential self-adjointness with respect to potential translations (see [72, Proposition 4.1]), it follows that  $(-\Delta + V)$  is essentially self-adjoint on  $C_c^\infty(M)$ , obtaining the claim.  $\square$

**Remark 5.2.3.** We stress that the bound  $2 + 2\sqrt{1 - C}$  is sharp. Namely, for  $h = 3$  and for every  $n \geq 3$  and  $C < 1 - (h - 2)^2/4 = 3/4$  there exist a  $C^2$   $n$ -dimensional Riemannian manifold  $N$  and a compact set  $K \subset N$  such that

- $|B_r(K)| \leq Er^h$  for  $r$  small enough and
- the equation  $(-\Delta + C/r^2)u = 0$  admits an  $L^2(M)$  solution, which in turn proves that  $-\Delta + \frac{C}{r^2} : C_c^\infty(M) \subset L^2(M) \rightarrow L^2(M)$  is not essentially self-adjoint.

Indeed, suppose first that  $n = h = 3$  and  $C < 3/4$ . Let  $N := (\mathbb{R}_{\geq 0} \times_\sigma \mathbb{S}^2, dr + \sigma^2 g^{\mathbb{S}^2})$  be the model manifold with coordinates  $(r, \theta)$  associated to the warping function

$$\sigma(r) := r(1 + r^2)(1 + (2/b + 1)r^2)^{-\frac{3}{2(2+b)}},$$

where  $b \in (1, \frac{3}{2})$  solves  $C = b^2 - b \in (0, \frac{3}{4})$ . Note that  $\sigma'(0) = 1$  and  $\sigma(0) = \sigma''(0) = 0$  so that  $N$  is  $C^2$ . Let  $K = \{0\}$  be the pole of the model manifold  $N$  and define  $M := N \setminus K$  and  $u : M \rightarrow \mathbb{R}$  given by

$$u(r, \theta) := \frac{1}{r^b(1 + r^2)}.$$

In particular,  $u$  is a positive function satisfying

$$\left(-\Delta + \frac{C}{r^2}\right)u = 0$$

on  $M$ . Moreover  $u \in L^2(M)$  since

$$\int_M u^2 \, dv = b^{\frac{3}{2+b}} 4\pi \int_0^{+\infty} r^{2(1-b)} (b + (2+b)r^2)^{-\frac{3}{2+b}} \, dv,$$

which is integrable both around 0 and at  $+\infty$  thanks to the choice of  $b$ . Examples with  $n > 3 = h$  can be obtained by considering  $N^3 \times \mathbb{T}^{n-3}$  where  $N^3$  is as above,  $\mathbb{T}^{n-3}$  is a  $(n-3)$ -dimensional torus, and  $K = \{0\} \times \mathbb{T}^{n-3}$ . We believe that similar counterexamples should exist also for non-integer  $h \in (2, 4)$ , even if in that case we expect explicit computations to be much more tricky.

### 5.3 Operator core

The second application of Theorem 5.1.1 we present is the generalization of Theorem 5.2.2 to the context of  $L^p$  spaces with  $p \neq 2$ . Indeed, in this case a similar conclusion can be proved just replacing the self-adjointness with the property that  $C_c^\infty$  is an operator core for  $L^p$ .

### 5.3.1 Standard notions and results about accretive operators

We start by recalling the following definition.

**Definition 5.3.1** (Strongly continuous semigroup). *A family of bounded operators  $\{T(t)\}_{t \in \mathbb{R}_{\geq 0}}$  defined over a Banach space  $B$  is a strongly continuous semigroup if*

- $T(0) = I$ ;
- $T(s)T(t) = T(s+t)$  for all  $s, t \in \mathbb{R}_{\geq 0}$ ;
- for each  $\psi \in B$  the map  $t \mapsto T(t)\psi$  is continuous.

A special class of such semigroups is given by the contraction semigroups. A strongly continuous semigroup  $\{T(t)\}$  defined over a Banach space  $(B, \|\cdot\|_B)$  is said to be a *contraction semigroup* if

$$\|T(t)\| \leq 1 \quad \forall t \in \mathbb{R}_{\geq 0}.$$

Here  $\|\cdot\|$  denotes the operator norm. The next proposition ([94, Page 237]) shows that any contraction semigroup can be “generated” by a closed operator.

**Proposition 5.3.2.** *Let  $T(t)$  be a strongly continuous semigroup on a Banach space  $B$  and set*

$$A_t := t^{-1}(I - T(t))$$

and

$$A := \lim_{t \rightarrow 0} A_t$$

defined over  $D(A) := \{\psi : \lim_{t \rightarrow 0} A_t\psi \text{ exists}\}$ . Then,  $A$  is closed and densely defined.

The operator  $A$  is called the *infinitesimal generator* of  $T(t)$ . We also say that  $A$  generates  $T(t)$  and write  $T(t) = e^{-tA}$ .

In the remaining part of the subsection, we introduce the notions of accretive and maximal accretive operators. To this aim, we recall that given a Banach space  $B$  and  $\psi \in B$ , an element  $l \in B^*$  is said to be a *normalized tangent functional* to  $\psi$  if it satisfies

$$\|l\|_{B^*} = \|\psi\|_B \quad \text{and} \quad l(\psi) = \|\psi\|_B^2.$$

Observe that by the Hahn-Banach theorem, each  $\psi \in B$  has at least one normalized tangent functional.

**Definition 5.3.3** (Accretive and m-accretive operator). *A densely defined operator  $A$  over a Banach space  $B$  is said to be accretive if for any  $\psi \in D(A)$  there exists  $l \in B^*$  a normalized tangent functional to  $\psi$  so that  $\operatorname{Re}(l(A\psi)) \geq 0$ .*

*An accretive operator  $A$  is said to be maximal accretive (or m-accretive) if it has no proper accretive extensions.*

**Remark 5.3.4.** We stress that

- every accretive operator is closable;
- the closure of an accretive operator is again accretive.

As a consequence, every accretive operator has a smallest closed accretive extension. For a reference see [94, Section X.8].

We can now state the fundamental criterion.

**Theorem 5.3.5** (Fundamental criterion). *A closed operator  $A$  on a Banach space  $B$  is the generator of a contraction semigroup if and only if  $A$  is accretive and  $\text{Ran}(\lambda_0 + A) = B$  for some  $\lambda_0 > 0$ .*

*Proof.* We refer to [94, Theorem X.48]. □

**Remark 5.3.6.** We stress that

1. by the Hille-Yosida theorem ([94, Theorem X.47a]), if  $A$  is the generator of a contraction semigroup, then the open half-line  $(-\infty, 0)$  is contained in the resolvent of  $A$ . In particular, it follows that  $\text{Ran}(I + A) = B$ ;
2. the generators of contraction semigroups are maximal accretive since the condition  $\text{Ran}(I + A) = B$  implies that  $A$  has no proper accretive extensions. The converse ( $A$  maximal accretive implies  $A$  generates a contraction semigroup) holds if  $B$  is an Hilbert space but not in the general Banach case. See [94, Page 241].

### 5.3.2 Main result

Let  $V \in L_{loc}^\infty(M)$  and consider the differential operator  $-\Delta + V$ . If  $p \in (1, +\infty)$ , we define the operator  $(-\Delta + V)_{p,max}$  associated to  $-\Delta + V$  by the formula

$$(-\Delta + V)_{p,max}u = (-\Delta + V)u$$

with domain

$$D((-\Delta + V)_{p,max}) = \{u \in L^p(M) : Vu \in L_{loc}^1(M), (-\Delta + V)u \in L^p(M)\}.$$

and the operator  $(-\Delta + V)_{p,min}$  as

$$(-\Delta + V)_{p,min} := (-\Delta + V)_{p,max} \Big|_{C_c^\infty(M)}.$$

Observe that since  $V \in L_{loc}^p(M)$ , then  $C_c^\infty(M) \subset D((-\Delta + V)_{p,max})$  and hence the last definition makes sense.

**5.3.2.1**  $\overline{(-\Delta + V)_{p,\min}}$  is m-accretive

The remaining part of this section is devoted to prove that the closure of  $(-\Delta + V)_{p,\min}$  coincides with  $(-\Delta + V)_{p,\max}$ . Following the strategy of the proof adopted by O. Milatovic in [71, Section 2], the first step consists in proving that  $\overline{(-\Delta + V)_{p,\min}}$  is m-accretive. To this aim, we first prove that this operator is accretive: it is a consequence of the next

**Lemma 5.3.7.** *Let  $(M, g)$  be a (possibly incomplete) Riemannian manifold. Consider  $0 \leq V \in L_{loc}^\infty(M)$  and let  $p \in (1, +\infty)$ .*

*Then, the operator  $(-\Delta + V)_{p,\min}$  satisfies*

$$\left\langle (-\Delta + V)_{p,\min} u, u|u|^{p-2} \right\rangle_{L^2} \geq 0 \quad \forall u \in C_c^\infty(M). \quad (5.3.1)$$

**Remark 5.3.8.** As suggested in the proof of [47, Proposition 2.9 (b)], Lemma 2.1 in [71] can be readapted to the setting of incomplete Riemannian manifolds, implying the validity of Lemma 5.3.7.

**Remark 5.3.9.** By definition, (5.3.1) means that  $(-\Delta + V)_{p,\min}$  is accretive. Indeed, for every  $u \in L^p$  with  $\|u\|_{L^p} \neq 0$  the functional  $l := \frac{u|u|^{p-2}\|u\|_{L^p}^2}{\|u\|_{L^p}^p} \in L^{p'}(M) = (L^p(M))^*$ , where  $p' = \frac{p}{p-1}$ , is a normalized tangent functional to  $u$  and, by (5.3.1), it holds

$$l((-\Delta + V)_{p,\min} u) = \langle (-\Delta + V)_{p,\min} u, l \rangle_{L^2} \geq 0.$$

By Remark 5.3.4 it follows that  $(-\Delta + V)_{p,\min}$  is closable and  $\overline{(-\Delta + V)_{p,\min}}$  is accretive in  $L^p(M)$ . Thus, by the definition of accretive operator,

$$\left\langle \overline{(-\Delta + V)_{p,\min}} u, u|u|^{p-2} \right\rangle \geq 0 \quad \forall u \in D\left(\overline{(-\Delta + V)_{p,\min}}\right) \quad (5.3.2)$$

where  $\langle \cdot, \cdot \rangle$  is the anti-duality of the pair  $(L^p, L^{p'})$ .

From now on we consider a complete Riemannian manifold  $(N, h)$  and define  $M := N \setminus K$ , where  $K \subset N$  is a compact subset. Let  $V \in L_{loc}^\infty(M)$  so that

$$V(x) \geq \frac{C}{r^m(x)} \quad \text{in } M,$$

where  $C \in [0, 1]$  and  $m \in \{0, 2\}$  are positive constants and  $r(x) := d^N(x, K)$  is the distance function from  $K$ , and fix  $p \in (1, +\infty)$ . Suppose there exist two positive constants  $E \geq 1$  and

$$h \geq \begin{cases} 0 & \text{if } m = 2 \text{ and } C = \frac{1}{p-1} \\ p + p\sqrt{1 - \frac{C}{p-1}} & \text{if } m = 2 \text{ and } C \in \left(0, \frac{1}{p-1}\right) \\ 2p & \text{if } m = 0 \end{cases} \quad \text{in case } p \geq 2$$

or

$$h \geq \begin{cases} 0 & \text{if } m = 2 \text{ and } C = p-1 \\ \frac{p+p\sqrt{1-(p-1)C}}{p-1} & \text{if } m = 2 \text{ and } C \in (0, p-1) \\ \frac{2p}{p-1} & \text{if } m = 0 \end{cases} \quad \text{in case } p < 2$$

so that

$$|B_r(K)| \leq Er^h \quad \text{as } r \rightarrow 0.$$

In what follows we always assume to be in this setting.

**Remark 5.3.10.** We stress that in the present section we are requiring the validity of a condition stronger than the one of (5.1.1) for the two indexes  $p$  and  $p' = p/(p-1)$  in order to obtain that both  $\overline{(-\Delta + V)_{p,min}}$  and  $\overline{(-\Delta + V)_{p',min}}$  are  $m$ -accretive. This latter will be used to ensure that the operator  $(-\Delta + V)_{p,max}$  is accretive too.

Thanks to the validity of Theorem 5.1.1, we are able to prove the next

**Theorem 5.3.11.**  $\overline{(-\Delta + V)_{p,min}}$  generates a contraction semigroup on  $L^p(M)$ . In particular,  $\overline{(-\Delta + V)_{p,min}}$  is  $m$ -accretive.

The proof of Theorem 5.3.11 can be obtained verbatim by the one of [71, Theorem 1.3] just readapting to our setting the Lemma 2.7 in the work of Milatovic. To this aim, we strongly use the validity of the positivity preserving property.

*Proof.* We proceed by steps.

**Step 1:** for any  $\lambda > 0$  the set  $\text{Ran}((-\Delta + V)_{p,min} + \lambda)$  is dense in  $L^p(M)$ . Let  $v \in L^{p'}(M)$  so that

$$\langle (\lambda + (-\Delta + V)_{p,min})u, v \rangle = 0 \quad \forall u \in C_c^\infty(M),$$

obtaining the following distributional equality

$$(\lambda - \Delta + V)v = 0.$$

Since by hypothesis  $V \in L^p_{loc}(M)$  and  $v \in L^{p'}(M)$ , by Hölder inequality  $Vv \in L^1_{loc}$ . Since  $\Delta v = Vv + \lambda v$ , we get  $\Delta v \in L^1_{loc}(M)$ . By Brezis-Kato's inequality

$$-\Delta|v| \leq -\Delta v \text{ sign } v = (-\lambda v - Vv) \text{ sign } v \leq -V|v|$$

and hence

$$(-\Delta + V)|v| \leq 0.$$

By Theorem 5.1.1 it follows that  $|v| \leq 0$  and hence  $v = 0$ .

**Step 2:** for any  $\lambda > 0$  the following inequality holds for all  $u \in D(\overline{(-\Delta + V)_{p,min}})$

$$\lambda \|u\|_{L^p} \leq \left\| (\lambda + \overline{(-\Delta + V)_{p,min}})u \right\|_{L^p}.$$

Indeed, by (5.3.2) it follows that

$$\left\langle \left( \overline{(-\Delta + V)_{p,min}} + \lambda \right) u, u|u|^{p-2} \right\rangle \geq \lambda \langle u, u|u|^{p-2} \rangle$$

for all  $u \in D(\overline{(-\Delta + V)_{p,min}})$ . By Hölder inequality, if  $p' := \frac{p}{p-1}$ ,

$$\begin{aligned} \left\| \left( \overline{(-\Delta + V)_{p,min}} + \lambda \right) u \right\|_{L^p} \left\| |u|^{p-2} \right\|_{L^{p'}} &\geq \left\langle \left( \overline{(-\Delta + V)_{p,min}} + \lambda \right) u, |u|^{p-2} \right\rangle \\ &\geq \lambda \left\langle u, |u|^{p-2} \right\rangle \end{aligned}$$

for all  $u \in D(\overline{(-\Delta + V)_{p,min}})$ . Since  $\| |u|^{p-2} \|_{L^{p'}} = \|u\|_{L^p}^{p/p'}$ ,  $\langle u, |u|^{p-2} \rangle = \|u\|_{L^p}^p$  and  $p - \frac{p}{p'} = 1$ , dividing both sides of the last inequality by  $\|u\|_{L^p}^{p/p'}$  we get the claim.

**Step 3:** for any  $\lambda > 0$  we have  $\text{Ran} \left( \overline{(-\Delta + V)_{p,min}} + \lambda \right) = L^p(M)$ .

Fix  $f \in L^p(M)$ . By Step 1 there exists a sequence  $u_k \in C_c^\infty(M)$  such that

$$\left( \overline{(-\Delta + V)_{p,min}} + \lambda \right) u_k \xrightarrow{L^p} f.$$

By Step 2 it follows that  $u_k$  is a Cauchy sequence in  $L^p(M)$  and hence  $u_k \xrightarrow{L^p} u$ . By the definition of a closed operator, it follows that  $u \in D(\overline{(-\Delta + V)_{p,min}} + \lambda)$  and  $\left( \overline{(-\Delta + V)_{p,min}} + \lambda \right) u = f$ .

**Step 4:**  $\overline{(-\Delta + V)_{p,min}}$  generates a contraction semigroup.

By Remark 5.3.9 the operator  $\overline{(-\Delta + V)_{p,min}}$  is accretive in  $L^p(M)$  and by Step 3 we have  $\text{Ran} \left( \overline{(-\Delta + V)_{p,min}} + \lambda \right) = L^p(M)$  for all  $\lambda > 0$ . By Theorem 5.3.5 it follows that  $\overline{(-\Delta + V)_{p,min}}$  is the generator of a contraction semigroup on  $L^p(M)$  and hence, by Remark 5.3.6, it follows that  $\overline{(-\Delta + V)_{p,min}}$  is m-accretive.  $\square$

### 5.3.2.2 $(-\Delta + V)_{p,max}$ is m-accretive

Once that we managed to prove that  $\overline{(-\Delta + V)_{p,min}}$  is m-accretive, the following stage is to show the same property for the operator  $(-\Delta + V)_{p,max}$ . This fact is a direct consequence of the next Lemma, contained in [49, Lemma I.25].

**Lemma 5.3.12.** *If  $p \in (1, +\infty)$  and  $p' = \frac{p}{p-1}$ , then*

$$(-\Delta + V)_{p,max} = \left( (-\Delta + V)_{p',min} \right)^*.$$

As Lemma 5.3.12 shows, given a Schrödinger operator  $-\Delta + V$ , the validity of any property of its  $p'$ -maximal operator  $(-\Delta + V)_{p,max}$  is equivalent to the validity of the same property for (the closure of) its  $p$ -minimal operator and vice versa. Whence, there is a strong connection between the behaviour of  $-\Delta + V$  as an operator acting on  $L^p$  and its behaviour as an operator acting on  $L^{p'} = (L^p)^*$ . This duality motivated our double Minkowski condition required at the beginning of this section, which ensures the positivity preserving property both for  $L^p$  and  $L^{p'}$  functions and lets us to obtain the next theorem.



**Theorem 5.3.13.**  $(-\Delta + V)_{p,max}$  generates a contraction semigroup on  $L^p$ . In particular,  $(-\Delta + V)_{p,max}$  is  $m$ -accretive.

*Proof.* The proof follows as in [50, Theorem 5]. Indeed, by Theorem 5.3.11 the operator  $(-\Delta + V)_{p',min}$  generates a contraction semigroup and by Lemma 5.3.12

$$(-\Delta + V)_{p,max} = \left( \overline{(-\Delta + V)_{p',min}} \right)^* .$$

Since adjoints of generators of contraction semigroups in reflexive Banach spaces again generate such semigroups [5, p.138], it follows that  $(-\Delta + V)_{p,max}$  generates a contraction semigroup and thus is  $m$ -accretive.  $\square$

### 5.3.2.3 $C_c^\infty$ is an operator core for $(-\Delta + V)_{p,max}$

Before proceeding with the main result of this section, we recall the following

**Definition 5.3.14** (Core of an operator). Let  $T$  be a closed operator over a Banach space  $B$ . For any closable operator  $S$  such that  $\overline{S} = T$ , its domain  $D(S)$  is said to be a core of  $T$ .

In other words,  $D \subset D(T)$  is a core of  $T$  if the set  $\{(u, Tu) : u \in D\}$  is dense in  $\Gamma(T)$ .

**Theorem 5.3.15.** Let  $(N, h)$  be a complete Riemannian manifold and define  $M := N \setminus K$ , where  $K \subset N$  is a compact subset. Consider  $V \in L_{loc}^\infty(M)$  so that

$$V(x) \geq \frac{C}{r^m(x)} - B \quad \text{in } M,$$

where  $C \in [0, 1]$ ,  $B$  and  $m \in \{0, 2\}$  are positive constants and  $r(x) := d^N(x, K)$  is the distance function from  $K$ , and fix  $p \in (1, +\infty)$ .

If there exist two positive constants  $E \geq 1$  and

$$h \geq \begin{cases} 0 & \text{if } m = 2 \text{ and } C = \frac{1}{p-1} \\ p + p\sqrt{1 - \frac{C}{p-1}} & \text{if } m = 2 \text{ and } C \in \left(0, \frac{1}{p-1}\right) \\ 2p & \text{if } m = 0 \end{cases} \quad \text{in case } p \geq 2 \quad (5.3.3)$$

or

$$h \geq \begin{cases} 0 & \text{if } m = 2 \text{ and } C = p - 1 \\ \frac{p+p\sqrt{1-(p-1)C}}{p-1} & \text{if } m = 2 \text{ and } C \in (0, p-1) \\ \frac{2p}{p-1} & \text{if } m = 0 \end{cases} \quad \text{in case } p < 2 \quad (5.3.4)$$

so that

$$|B_r(K)| \leq Er^h \quad \text{as } r \rightarrow 0, \quad (5.3.5)$$

then  $C_c^\infty(M)$  is an operator core for  $(-\Delta + V)_{p,max}$ .

*Proof.* Let  $\tilde{V} = V + B > 0$ . By Theorem 5.3.11 and Theorem 5.3.13, both  $\overline{(-\Delta + \tilde{V})_{p,\min}}$  and  $(-\Delta + \tilde{V})_{p,\max}$  are m-accretive. By the fact that  $\overline{(-\Delta + \tilde{V})_{p,\min}} \subset (-\Delta + \tilde{V})_{p,\max}$  and by the definition of m-accretive operator, it follows that  $\overline{(-\Delta + \tilde{V})_{p,\min}} = (-\Delta + \tilde{V})_{p,\max}$ , obtaining that  $C_c^\infty(M)$  is an operator core for  $(-\Delta + \tilde{V})_{p,\max}$ . By the invariance of this property with respect to potential translations (see Remark 5.3.16 below), we get the claim.  $\square$

**Remark 5.3.16.** We observe that  $C_c^\infty(M)$  is an operator core for  $(-\Delta + V)_{p,\max}$ , then  $C_c^\infty$  is an operator core also for  $(-\Delta + V + \lambda)_{p,\max}$  for every  $\lambda \in \mathbb{R}$ .

Indeed, suppose that  $C_c^\infty(M)$  is an operator core for  $(-\Delta + V)_{p,\max}$ , meaning that  $\{(u, (-\Delta + V)u) : u \in C_c^\infty(M)\}$  is dense in  $\Gamma((-\Delta + V)_{p,\max})$ . Fixed  $\lambda \in \mathbb{R}$ , consider  $(u, (-\Delta + V + \lambda)u) \in \Gamma((-\Delta + V + \lambda)_{p,\max})$  and observe that

$$D((-\Delta + V + \lambda)_{p,\max}) = D((-\Delta + V)_{p,\max})$$

and hence

$$(u, (-\Delta + V)u) \in \Gamma((-\Delta + V)_{p,\max}).$$

By the fact that  $C_c^\infty(M)$  is an operator core for  $(-\Delta + V)_{p,\max}$  it follows that there exists  $\{u_n\}_n \subset C_c^\infty(M)$  so that

$$(u_n, (-\Delta + V)u_n) \xrightarrow{n} (u, (-\Delta + V)u) \quad \text{in } \Gamma((-\Delta + V)_{p,\max}),$$

i.e.

$$\|u_n - u\|_{L^p} + \|(-\Delta + V)(u_n - u)\|_{L^p} \xrightarrow{n} 0,$$

implying that

1.  $\|u_n - u\|_{L^p} \xrightarrow{n} 0$
2.  $\|(-\Delta + V)(u_n - u)\|_{L^p} \xrightarrow{n} 0$ .

Whence, by Minkowski inequality,

$$\|(-\Delta + V + \lambda)(u_n - u)\|_{L^p} \leq \|(-\Delta + V)(u_n - u)\|_{L^p} + |\lambda| \|u_n - u\|_{L^p} \xrightarrow{n} 0.$$

and hence  $(-\Delta + V + \lambda)u_n \xrightarrow{L^p} (-\Delta + V + \lambda)u$ . So

$$(u_n, (-\Delta + V + \lambda)u_n) \xrightarrow{n} (u, (-\Delta + V + \lambda)u) \quad \text{in } \Gamma((-\Delta + V + \lambda)_{p,\max}).$$

It follows that for every  $\lambda \in \mathbb{R}$  the set  $\{(u, (-\Delta + V + \lambda)u) : u \in C_c^\infty(M)\}$  is dense in  $\Gamma((-\Delta + V + \lambda)_{p,\max})$  and hence  $C_c^\infty(M)$  is an operator core for  $(-\Delta + V + \lambda)_{p,\max}$ .

**Remark 5.3.17.** In case  $p = 2$  (and hence  $p' = 2$ ), we recover the result contained in Theorem 5.2.2. Indeed, under the assumptions of Theorem 5.2.2, the condition

$$C_c^\infty(M) \text{ is an operator core for } (-\Delta + V)_{2,\max}$$

means exactly that the operator  $-\Delta + V$  is essentially self-adjoint on  $C_c^\infty(M)$ .

### 5.3.3 Consequence of the above construction

As we can see from the previous discussion, the construction carried out in this section is guaranteed even under more general assumptions than those required in Theorem 5.3.15. In fact, we can observe that for the proofs of Theorems 5.3.11 and 5.3.13, which are the key results from which Theorem 5.3.15 immediately follows, only the property of positivity preservation for the operator  $-\Delta + V$  is required. As a direct consequence of this fact, we obtain a machinery that ensures that  $C_c^\infty$  is an operator core for the  $p$ -maximal extension of a given Schrödinger operator as soon as the underlying manifold satisfies the positivity preservation for that operator for the index  $p$  and for its dual  $p'$ . We summarize this result in the following

**Theorem 5.3.18.** *Let  $(M, g)$  be a (possibly incomplete) Riemannian manifold. Consider  $0 < V \in L_{loc}^\infty(M)$  and  $p \in (1, +\infty)$  and define  $p' = \frac{p}{p-1}$ .*

*If  $(M, g)$  satisfies both the  $L^p$  and  $L^{p'}$  positivity preserving property for the operator  $-\Delta + V$ , then  $C_c^\infty(M)$  is an operator core for  $(-\Delta + V)_{p, \max}$ .*



---

# Bibliography

---

- [1] S. Agmon. On positivity and decay of solutions of second order elliptic equations on Riemannian manifolds. *Methods of functional analysis and theory of elliptic equations*, pages 19–52, 1982.
- [2] L. J. Alías, P. Mastrolia, and M. Rigoli. *Maximum principles and geometric applications*. Springer Monographs in Mathematics. Springer, Cham, 2016.
- [3] N. D. Alikakos and P. W. Bates. On the singular limit in a phase field model of phase transitions. 5(2):141–178, 1988.
- [4] A. Ambrosetti and A. Malchiodi. *Nonlinear analysis and semilinear elliptic problems*, volume 104. Cambridge university press, 2007.
- [5] W. Arendt, C. J. K. Batty, M. Hieber, and F. Neubrander. *Vector-valued Laplace transforms and Cauchy problems*, volume 96 of *Monographs in Mathematics*. Birkhäuser/Springer Basel AG, Basel, second edition, 2011.
- [6] M. Batista and J. I. Santos. A note on local minimizers of energy on complete manifolds. *Topol. Methods Nonlinear Anal.*, 60(2):565–579, 2022.
- [7] F. Bei and B. Güneysu. Kac regular sets and Sobolev spaces in geometry, probability and quantum physics. *Mathematische Annalen*, 379:1623–1650, 2021.
- [8] H. Berestycki, L. Caffarelli, and L. Nirenberg. Symmetry for elliptic equations in a half space. *Boundary value problems for partial differential equations and applications*, 29:27–42, 1993.
- [9] H. Berestycki, L. A. Caffarelli, and L. Nirenberg. Inequalities for second-order elliptic equations with applications to unbounded domains i. *Duke Mathematical Journal*, 81(2):467–494, 1996.
- [10] H. Berestycki, L. A. Caffarelli, and L. Nirenberg. Monotonicity for elliptic equations in unbounded Lipschitz domains. *Communications on Pure and Applied Mathematics*, 50(11):1089–1111, 1997.
- [11] H. Berestycki, L. Nirenberg, and S. R. S. Varadhan. The principal eigenvalue and maximum principle for second-order elliptic operators in general domains. *Comm. Pure Appl. Math.*, 47(1):47–92, 1994.

- [12] H. Berestycki and L. Rossi. Generalizations and properties of the principal eigenvalue of elliptic operators in unbounded domains. *Communications on Pure and Applied Mathematics*, 68(6):1014–1065, 2015.
- [13] A. L. Besse. *Manifolds all of whose geodesics are closed*, volume 93. Springer Science & Business Media, 1978.
- [14] D. Bianchi and A. G. Setti. Laplacian cut-offs, porous and fast diffusion on manifolds and other applications. *Calc. Var. Partial Differential Equations*, 57(1):Paper No. 4, 33, 2018.
- [15] D. Bianchi and A. G. Setti. Laplacian cut-offs, porous and fast diffusion on manifolds and other applications. *Calculus of Variations and Partial Differential Equations*, 57(1):1–33, 2018.
- [16] A. Bisterzo. Maximum principles in unbounded riemannian domains. *arXiv preprint, arXiv:2309.09895*, 2023.
- [17] A. Bisterzo, A. Farina, and S. Pigola.  $L^p_{loc}$  positivity preservation and Liouville-type theorems. *arXiv preprint, arXiv:2304.00745*, 2023.
- [18] A. Bisterzo and L. Marini. The  $L^\infty$ -positivity Preserving Property and Stochastic Completeness. *Potential Analysis*, 2022.
- [19] A. Bisterzo and S. Pigola. Symmetry of solutions to semilinear PDEs on Riemannian domains. *Nonlinear Analysis*, 234:113320, 2023.
- [20] A. Bisterzo and G. Veronelli.  $L^p$  positivity preservation and self-adjointness on incomplete Riemannian manifolds. *arXiv preprint, arXiv:2310.11118*, 2023.
- [21] A. Bonfiglioli and E. Lanconelli. Subharmonic functions in sub-Riemannian settings. *Journal of the European Mathematical Society*, 15(2):387–441, 2013.
- [22] M. Braverman, O. Milatovich, and M. Shubin. Essential selfadjointness of Schrödinger-type operators on manifolds. *Uspekhi Mat. Nauk*, 57(4(346)):3–58, 2002.
- [23] H. Brezis. Semilinear equations in  $\mathbb{R}^N$  without condition at infinity. *Applied Mathematics and Optimization*, 12:271–282, 1984.
- [24] H. Brézis and L. Nirenberg. Positive solutions of nonlinear elliptic equations involving critical Sobolev exponents. *Communications on pure and applied mathematics*, 36(4):437–477, 1983.
- [25] X. Cabré. Nondivergent elliptic equations on manifolds with nonnegative curvature. *Communications on Pure and Applied Mathematics*, 50(7):623–665, 1997.
- [26] E. J. Cartan. Familles de surfaces isoparamétriques dans les espaces à courbure constante. *Annali di Matematica Pura ed Applicata*, 17:177–191, 1938.

- [27] N. Charalambous and Z. Lu. Heat kernel estimates and the essential spectrum on weighted manifolds. *J. Geom. Anal.*, 25(1):536–563, 2015.
- [28] D. Chenaïs. On the existence of a solution in a domain identification problem. *Journal of Mathematical Analysis and Applications*, 52(2):189–219, 1975.
- [29] G. Cupini and E. Lanconelli. On mean value formulas for solutions to second order linear PDEs. *Annali della Scuola Normale Superiore di Pisa. Classe di scienze*, 22(2):777–809, 2021.
- [30] B. Devyver. On the finiteness of the Morse index for Schrödinger operators. *Manuscripta mathematica*, 139(1-2):249–271, 2012.
- [31] M. P. do Carmo. *Riemannian geometry*. Birkhäuser Boston, Inc., Boston, MA, 1992.
- [32] M. Domínguez-Vázquez. An introduction to isoparametric foliations. *Preprint*, 2018.
- [33] L. D. Drager, J. M. Lee, E. Park, and K. Richardson. Smooth distributions are finitely generated. *Annals of Global Analysis and Geometry*, 41:357–369, 2012.
- [34] L. Dupaigne. *Stable solutions of elliptic partial differential equations*. CRC press, 2011.
- [35] L. Dupaigne and A. Farina. Classification and Liouville-type theorems for semilinear elliptic equations in unbounded domains. *Analysis & PDE*, 15(2):551–566, 2022.
- [36] L. Dupaigne and A. Farina. Regularity and symmetry for semilinear elliptic equations in bounded domains. *Commun. Contemp. Math.*, 25(5):Paper No. 2250018, 27, 2023.
- [37] A. Farina, L. Mari, and E. Valdinoci. Splitting theorems, symmetry results and overdetermined problems for Riemannian manifolds. *Communications in Partial Differential Equations*, 38(10):1818–1862, 2013.
- [38] D. Fischer-Colbrie and R. Schoen. The structure of complete stable minimal surfaces in 3-manifolds of non-negative scalar curvature. *Communications on Pure and Applied Mathematics*, 33(2):199–211, 1980.
- [39] M. P. Gaffney. A special Stokes’s theorem for complete Riemannian manifolds. *Annals of Mathematics*, pages 140–145, 1954.
- [40] B. Gidas, W.-M. Ni, and L. Nirenberg. Symmetry and related properties via the maximum principle. *Communications in mathematical physics*, 68(3):209–243, 1979.
- [41] D. Gilbarg, N. S. Trudinger, D. Gilbarg, and N. Trudinger. *Elliptic partial differential equations of second order*, volume 224. Springer, 1977.
- [42] A. Grigor’yan. Analytic and geometric background of recurrence and non-explosion of the Brownian motion on Riemannian manifolds. *Bull. Amer. Math. Soc. (N.S.)*, 36(2):135–249, 1999.

- [43] A. Grigor'yan. Heat kernels on weighted manifolds and applications. In *The ubiquitous heat kernel*, volume 398 of *Contemp. Math.*, pages 93–191. Amer. Math. Soc., Providence, RI, 2006.
- [44] A. Grigor'yan. *Heat kernel and analysis on manifolds*, volume 47 of *AMS/IP Studies in Advanced Mathematics*. American Mathematical Society, Providence, RI; International Press, Boston, MA, 2009.
- [45] A. Grigor'yan and J. Masamune. Parabolicity and stochastic completeness of manifolds in terms of the Green formula. *Journal de Mathématiques Pures et Appliquées*, 100(5):607–632, 2013.
- [46] G. Grillo, K. Ishige, and M. Muratori. Nonlinear characterizations of stochastic completeness. *J. Math. Pures Appl. (9)*, 139:63–82, 2020.
- [47] B. Güneysu. Sequences of Laplacian cut-off functions. *J. Geom. Anal.*, 26(1):171–184, 2016.
- [48] B. Güneysu. The BMS conjecture. *Ulmer Seminare*, 20:97–101, 2017. ArXiv preprint: arXiv:1709.07463.
- [49] B. Güneysu. *Covariant Schrödinger semigroups on Riemannian manifolds*, volume 264 of *Operator Theory: Advances and Applications*. Birkhäuser/Springer, Cham, 2017.
- [50] B. Güneysu and S. Pigola.  $L^p$ -interpolation inequalities and global Sobolev regularity results (with an appendix by Ognjen Milatovic). *Annali di Matematica Pura ed Applicata (1923-)*, 198:83–96, 2019.
- [51] B. Güneysu, S. Pigola, P. Stollmann, and G. Veronelli. A new notion of subharmonicity on locally smoothing spaces, and a conjecture by Braverman, Milatovic, Shubin. *arXiv preprint arXiv:2302.09423*, 2023.
- [52] B. Güneysu and O. Post. Path integrals and the essential self-adjointness of differential operators on noncompact manifolds. *Mathematische Zeitschrift*, 275(1-2):331–348, 2013.
- [53] E. Hebey. *Sobolev spaces on Riemannian manifolds*, volume 1635. Springer Science & Business Media, 1996.
- [54] E. Hebey. *Nonlinear analysis on manifolds: Sobolev spaces and inequalities: Sobolev spaces and inequalities*, volume 5. American Mathematical Soc., 2000.
- [55] E. Hebey and M. Herzlich. Harmonic coordinates, harmonic radius and convergence of Riemannian manifolds. *Rend. Mat. Appl. (7)*, 17(4):569–605, 1997.
- [56] S. Heikkilä and V. Lakshmikantham. *Monotone iterative techniques for discontinuous nonlinear differential equations*. Routledge, 2017.



- [57] S. Honda, L. Mari, M. Rimoldi, and G. Veronelli. Density and non-density of  $C_c^\infty \leftrightarrow W^{k,p}$  on complete manifolds with curvature bounds. *Nonlinear Anal.*, 211:Paper No. 112429, 26, 2021.
- [58] P. Hsu. Heat semigroup on a complete Riemannian manifold. *Ann. Probab.*, 17(3):1248–1254, 1989.
- [59] D. Impera, J. H. de Lira, S. Pigola, and A. G. Setti. Height estimates for Killing graphs. *The Journal of Geometric Analysis*, 28:2857–2885, 2018.
- [60] D. Impera, S. Pigola, and A. G. Setti. Potential theory for manifolds with boundary and applications to controlled mean curvature graphs. *Journal für die reine und angewandte Mathematik (Crelles Journal)*, 2017(733):121–159, 2017.
- [61] D. Impera, M. Rimoldi, and G. Veronelli. Higher order distance-like functions and Sobolev spaces. *Advances in Mathematics*, 396:108166, 2022.
- [62] E. Indrei, A. Minne, and L. Nurbekyan. Regularity of solutions in semilinear elliptic theory. *Bulletin of Mathematical Sciences*, 7:177–200, 2017.
- [63] L. Karp. Differential inequalities on complete Riemannian manifolds and applications. *Math. Ann.*, 272(4):449–459, 1985.
- [64] T. Kato. Schrödinger operators with singular potentials. *Israel J. Math.*, 13:135–148 (1973), 1972.
- [65] T. Kato. *Perturbation theory for linear operators*, volume 132. Springer Science & Business Media, 2013.
- [66] G. Knieper. A survey on noncompact harmonic and asymptotically harmonic manifolds. *Geometry, topology, and dynamics in negative curvature*, 425:146–197, 2016.
- [67] S. Kumaresan and J. Prajapat. Analogue of Gidas-Ni-Nirenberg result in hyperbolic space and sphere. *Rend. Istit. Mat. Univ. Trieste*, 30(1–2):107–112, 1998.
- [68] A. Lichnerowicz. Sur les espaces riemanniens completement harmoniques. *Bulletin de la Société Mathématique de France*, 72:146–168, 1944.
- [69] L. Mari, M. Rigoli, and A. G. Setti. Keller–Osserman conditions for diffusion-type operators on Riemannian manifolds. *Journal of Functional Analysis*, 258(2):665–712, 2010.
- [70] L. Marini and G. Veronelli. Some functional properties on cartan-hadamard manifolds of very negative curvature, 2021. ArXiv preprint: arXiv:2105.09024.
- [71] O. Milatovic. On  $m$ -accretivity of perturbed Bochner Laplacian in  $L^p$  spaces on Riemannian manifolds. *Integral Equations and Operator Theory*, 68(2):243–254, 2010.
- [72] O. Milatovic and F. Truc. Self-adjoint extensions of differential operators on Riemannian manifolds. *Annals of Global Analysis and Geometry*, 49:87–103, 2016.

- [73] K. Miller. Barriers on cones for uniformly elliptic operators. *Annali di Matematica Pura ed Applicata*, 76(1):93–105, 1967.
- [74] R. Miyaoka. Transnormal functions on a Riemannian manifold. *Differential Geometry and its Applications*, 31(1):130–139, 2013.
- [75] W. F. Moss and J. Piepenbrink. Positive solutions of elliptic equations. 1978.
- [76] L. Ni. Mean value theorems on manifolds. *Asian J. Math.*, 11(2):277–304, 2007.
- [77] S. Nordmann. Maximum principle and principal eigenvalue in unbounded domains under general boundary conditions. *arXiv preprint arXiv:2102.07558*, 2021.
- [78] P. Padilla. The principal eigenvalue and maximum principle for second order elliptic operators on Riemannian manifolds. *Journal of Mathematical Analysis and Applications*, 205(2):285–312, 1997.
- [79] L. F. Pessoa, S. Pigola, and A. G. Setti. Dirichlet parabolicity and  $L^1$ -liouville property under localized geometric conditions. *Journal of Functional Analysis*, 273(2):652–693, 2017.
- [80] P. Petersen. *Riemannian geometry*, volume 171 of *Graduate Texts in Mathematics*. Springer, Cham, third edition, 2016.
- [81] S. Pigola, M. Rigoli, and A. G. Setti. A remark on the maximum principle and stochastic completeness. *Proc. Amer. Math. Soc.*, 131(4):1283–1288, 2003.
- [82] S. Pigola, M. Rigoli, and A. G. Setti. A remark on the maximum principle and stochastic completeness. *Proc. Amer. Math. Soc.*, 131(4):1283–1288, 2003.
- [83] S. Pigola, M. Rigoli, and A. G. Setti. Maximum principles on Riemannian manifolds and applications. *Mem. Amer. Math. Soc.*, 174(822):x+99, 2005.
- [84] S. Pigola and A. G. Setti. Global divergence theorems in nonlinear PDEs and geometry. *Ensaïos Matemáticos*, 26(1-77):2, 2014.
- [85] S. Pigola, D. Valtorta, and G. Veronelli. Approximation, regularity and positivity preservation on Riemannian manifolds. *arXiv preprint arXiv:2301.05159*, 2023.
- [86] S. Pigola and G. Veronelli. The smooth Riemannian extension problem. *Ann. Sc. Norm. Super. Pisa Cl. Sci. (5)*, 20(4):1507–1551, 2020.
- [87] S. Pigola and G. Veronelli.  $L^p$  Positivity Preserving and a conjecture by M. Braverman, O. Milatovic and M. Shubin. *arXiv preprint arXiv:2105.14847*, 2021.
- [88] A. C. Ponce. Elliptic pdes, measures and capacities. *Tracts in Mathematics*, 23:10, 2016.
- [89] M. H. Protter and H. F. Weinberger. *Maximum principles in differential equations*. Springer-Verlag, New York, 1984. Corrected reprint of the 1967 original.

- 
- [90] L. Provenzano and A. Savo. Isoparametric foliations and the Pompeiu property. *Mathematics in Engineering*, 5(2):1–27, 2023.
- [91] A. Ranjan and H. Shah. Busemann functions in a harmonic manifold. *Geometriae Dedicata*, 101:167–183, 2003.
- [92] A. Ratto, M. Rigoli, and L. Véron. Scalar curvature and conformal deformation of hyperbolic space. *J. Funct. Anal.*, 121(1):15–77, 1994.
- [93] M. Reed and B. Simon. *Methods of Modern Mathematical Physics: Functional Analysis; Rev. ed.* Academic press, 1980.
- [94] M. Reed, B. Simon, and S. Reed. *Methods of Modern Mathematical Physics: Fourier Analysis, Self-Adjointness.* 1975.
- [95] M. Rigoli and A. G. Setti. Liouville type theorems for  $\varphi$ -subharmonic functions. *Revista Matemática Iberoamericana*, 17(3):471–520, 2001.
- [96] D. H. Sattinger. Monotone methods in nonlinear elliptic and parabolic boundary value problems. *Indiana University Mathematics Journal*, 21(11):979–1000, 1972.
- [97] A. Savo. Heat flow, heat content and the isoparametric property. *Mathematische Annalen*, 366(3-4):1089–1136, 2016.
- [98] A. Savo. Geometric rigidity of constant heat flow. *Calculus of Variations and Partial Differential Equations*, 57(6):156, 2018.
- [99] V. E. Shklover. Schiffer problem and isoparametric hypersurfaces. *Revista matemática iberoamericana*, 16(3):529–569, 2000.
- [100] M. Shubin. Essential self-adjointness for semi-bounded magnetic Schrödinger operators on non-compact manifolds. *Journal of Functional Analysis*, 186(1):92–116, 2001.
- [101] P. Sjögren. On the adjoint of an elliptic linear differential operator and its potential theory. *Arkiv för Matematik*, 11(1):153–165, 1973.
- [102] M. Struwe and M. Struwe. *Variational methods*, volume 991. Springer, 2000.
- [103] Q.-M. Wang. Isoparametric functions on Riemannian manifolds. i. *Mathematische Annalen*, 277:639–646, 1987.
- [104] K. Yano. Harmonic and Killing vector fields in compact orientable Riemannian spaces with boundary. *Annals of Mathematics*, pages 588–597, 1959.
- [105] S. T. Yau. Some function-theoretic properties of complete Riemannian manifold and their applications to geometry. *Indiana Univ. Math. J.*, 25(7):659–670, 1976.